

Compact Light Fitting
Series C-LUX 6100 / 6500



WWW.CABLEJOINTS.CO.UK
THORNE & DERRICK UK
TEL 0044 191 490 1547 FAX 0044 477 5371
TEL 0044 117 977 4647 FAX 0044 977 5582



E2



- > Suitable for wall or ceiling mounting
- > Can be fitted to order with emergency exit signs
- > Central locking
- > All-pole disconnection via N/C switch when cover is opened (Series 6100)

www.stahl.de



01907E00

Series C-LUX 6100 and 6500 compact light fittings can be used for normal lighting, but also as information fittings or as group- or centrally-powered emergency lights.

Zone	ATEX / GOST*					
	0	1	2	20	21	22
C-LUX 6100: For use in		x	x		x	x
C-LUX 6500: For use in			x		x	x

* only 6100

WebCode 6100A



WWW.CABLEJOINTS.CO.UK
THORNE & DERRICK UK
TEL 0044 191 490 1547 FAX 0044 477 5371
TEL 0044 117 977 4647 FAX 0044 977 5582

Compact Light Fitting
Series C-LUX 6100 / 6500







WWW.CABLEJOINTS.CO.UK
THORNE & DERRICK UK
TEL 0044 191 490 1547 FAX 0044 477 5371
TEL 0044 117 977 4647 FAX 0044 977 5582

Selection Table

Version	Lamps	Lamps	Electronic ballasts piece	Order number	Weight kg
C-LUX 6100 Zones 1, 21	Fluorescent lamp	1 x 8 W	1	6100/1081-8011-3430-00	3.390
		2 x 8 W	1	6100/1082-8011-3430-00	3.500
			2	6100/1082-9011-3430-00	2.400
		3 x 8 W	1	6100/1083-8011-3430-00	3.530
			2	6100/1083-9011-3430-00	2.600
C-LUX 6500 Zones 2, 21, 22	Fluorescent lamp	1 x 8 W	1	6500/1081-8010-8430-00	2.400
		2 x 8 W	2	6500/1082-9010-8430-00	2.500
		3 x 8 W	3	6500/1083-9010-8430-00	2.600
	DULUX-L lamp	1 x 24 W	1	6500/3241-8010-2430-00	2.400
	Incandescent lamp	1 x 60 W	--	6500/6601-0010-0430-00	2.150
		2 x 40 W	--	6500/6402-0010-0430-00	2.300

Order Number Supplement

Cable entries	Standard: 1 x cable gland M25 x 1.5 2 x stopping plugs M25 x 1.5	6.00/.....1.-.....	
	Special: Specify non-standard entries in writing	6.00/.....9.-.....	
Monitoring module	without	6.00/.....-0-..	
	with	6.00/.....-2-..	
Emergency exit	needed only when used as information lights or escape sign lights; With adhesive symbols positioned as follows: Mounting position Standard	 A	08481E00
	Special please specify other positions in writing		
	Please specify emergency exit sign number (see below)		
	Symbol complying with VGB 125, DIN 4844, DIN 5035; recognition distance e = 30 m; size 150 x 355 mm		
	without emergency exit sign	6.00/.....-00	
	 08483E00	Colours Sign Background white green	6.00/.....-60
 08482E00	Colours Sign Background white green	6.00/.....-61	
 08484E00	Colours Sign Background white green	6.00/.....-62	













Compact Light Fitting
Series C-LUX 6100 / 6500



WWW.CABLEJOINTS.CO.UK
THORNE & DERRICK UK
TEL 0044 191 490 1547 FAX 0044 477 5371
TEL 0044 117 977 4647 FAX 0044 977 5582



Order Number Supplement

Emergency exit	 <small>08485E00</small>	Colours	Sign Background	white green	6.00 /-91
	 <small>03206E00</small>	Colours	Sign Background	green white	6.00 /-71
	 <small>12617E00</small>	Colours	Sign Background	red white	6.00 /-81
	 <small>08486E00</small>	Colours	Sign Background	white green	6.00 /-92
	 <small>09020E00</small>	Colours	Sign Background	green white	6.00 /-72
	 <small>12618E00</small>	Colours	Sign Background	red white	6.00 /-82
	 <small>08487E00</small>	Colours	Sign Background	white green	6.00 /-90
	 <small>03203E00</small>	Colours	Sign Background	green white	6.00 /-70
	 <small>12616E00</small>	Colours	Sign Background	red white	6.00 /-80
	 <small>08488E00</small>	Colours	Sign Background	white green	6.00 /-93
	 <small>12615E00</small>	Colours	Sign Background	green white	6.00 /-73
	 <small>12619E00</small>	Colours	Sign Background	red white	6.00 /-83

Note Compact light fittings can be operated as emergency lighting via a group or central battery system; fittings are supplied without lamps, which must be ordered separately; further escape and information signs available on request.

E2



WWW.CABLEJOINTS.CO.UK
THORNE & DERRICK UK
TEL 0044 191 490 1547 FAX 0044 477 5371
TEL 0044 117 977 4647 FAX 0044 977 5582

Compact Light Fitting

Series C-LUX 6100 / 6500



WWW.CABLEJOINTS.CO.UK
THORNE & DERRICK UK
 TEL 0044 191 490 1547 FAX 0044 477 5371
 TEL 0044 117 977 4647 FAX 0044 977 5582

Explosion Protection

Europe (ATEX)

Version	6100 (Zones 1, 21)	6500 (Zones 2, 21, 22)
Gas	Zone 1: PTB 97 ATEX 2119 Zone 1: Ⓜ II 2 G EEx eds IIC T4	Zone 2: SNCH 03 ATEX 3558 Zone 2: Ⓜ II 3 G EEx n A II T4 (T3 for incandescent lamps)
Dust	Zone 21: LCIE 03 ATEX 6158 Zone 21: Ⓜ II 2 D IP66 T130°C	Zone 21: SNCH 03 ATEX 3557 Zone 22: SNCH 03 ATEX 3558 Zone 21: Ⓜ II 2 D IP66 T1) Zone 22: Ⓜ II 3 D IP66 T1) T85 °C for 8 W lamps; T68 °C for DULUX L lamps; T117 °C for incandescent lamps

Certificates and approvals

Version	6100 (Zones 1, 21)	6500 (Zones 2, 21, 22)
Certificates	ATEX, Canada (CSA), Kazakhstan (GOST-K), Russia (GOST-R), Serbia (IZP), Belarus (GOST-B)	ATEX, China (CQST), Canada (CSA), Russia (GOST-R), Serbia (IZP), Ukraine (GOST-U), USA (FM), Belarus (GOST-B)

Technical Data

Electrical data

Rated voltage	for fluorescent lamps: AC: 220 (- 10%) ... 240 (+ 10%) V; 50 / 60 Hz DC: 198 ... 250 V	
	for DULUX-L lamps: AC: 220 (- 10%) ... 240 (+ 6%) V; 50 / 60 Hz DC: 176 ... 254 V	
	for incandescent lamps: 230 V	
Version	6100 (Zones 1, 21)	6500 (Zones 2, 21, 22)
Disconnection of light fitting on opening	Central locking device with safety interlock; switch 8080 with N/C contacts; when central lock is opened, voltage to ballast is disconnected on both poles; a safety interlock in switching mechanism prevents fitting from being reconnected while cover and central lock are open.	Standard light fitting 6500: without switching off
Faulty lamp	If lamp is faulty power supply is automatically switched off by electronic ballast	

Luminous Characteristics

Lamps	Fluorescent lamps						DULUX-L	Incandescent lamps	
	Number of lamps	1 x 8 W	2 x 8 W	3 x 8 W		1 x 24 W	1 x 60 W	2 x 40 W	
	Electronic ballast	1	1	2	1	2	1	--	--
	Rated current	0.088 A	0.135 A	0.176 A	0.2 A	0.223 A	0.11 A	0.30 A	0.39 A
Light guides	Reflector painted white; Cover with prism structure providing directed light from fitting								
Operating modes	Mains operation for general lighting or as information lights. Emergency light operation, supplied from group or central battery system for emergency or escape route lighting.								

Ambient conditions

Version	6100 (Zones 1, 21)	6500 (Zones 2, 21, 22)
Ambient temperature	-20 ... +50 °C	-20 ... +50 °C (with fluorescent lamp) -20 ... +40 °C (with DULUX-L lamp) -50 ... +40 °C (with incandescent lamp)

Mechanical data

Degree of protection	IP66 (IP64 with breather 8162)
Protection class	I (with internal PE connection terminal)
Material	
Enclosure	glass fibre reinforced polyester resin colour: white, similar to RAL 9010
Lamp cover	Polycarbonate
Seal	Polyurethane; foamed into cover
Cover options	Central locking using socket spanner M8 / SW 13; cover hinged for access

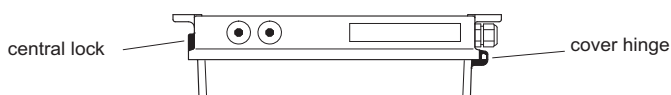

08478E02

Compact Light Fitting
Series C-LUX 6100 / 6500



WWW.CABLEJOINTS.CO.UK
THORNE & DERRICK UK
TEL 0044 191 490 1547 FAX 0044 477 5371
TEL 0044 117 977 4647 FAX 0044 977 5582



Technical Data

Assembly / Installation

Cable entry	
Standard	1 cable entry 8161 in plastic, M25 x 1.5 and 2 plugs 8290 in plastic, M25 x 1.5 (enclosed)
Special version	Other entries in moulded plastic or metal are available to order - details available on request.
Connection	
Terminal size	2 x 4 mm ² for solid cores 2 x 2.5 mm ² for flexible cores
Marking	L, N, PE
Terminal block	in polyamide with cover
Installation notes	
Mounting	Can be wall- or ceiling-mounted
Looping through of cables	2 leads can be connected to each terminal on the input side, making fittings suitable for looped connection

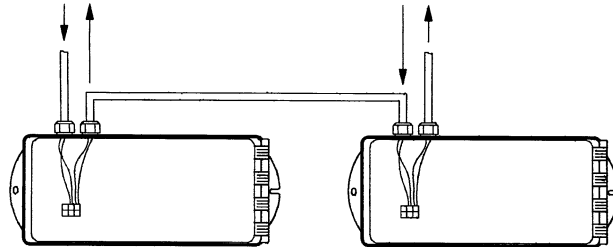

08480E00

Monitoring module

Function	Monitoring and switching module for emergency light systems according to VDE 0108: The module is used for the monitoring of individual lights and for the control of network and safety lights. The module offers the following functions: • Control of the light (ON / OFF) and function test • Up to 20 addresses can be set for each electric circuit by means of a coding switch • The operating mode of the lamp (continuous light, stand-by light or activation by means of a switch) is freely programmable • Mixed operation within one circuit is possible
Input voltage	(Input between L+ and N-) U _N 230 (+ 10 % / - 15 %) V AC, 50 Hz U _{DC} 175 ... 275 V DC
Control input	(between L and N) U _N 230 (+ 10 % / - 15 %) V AC, 50 Hz
Connected power (output to light)	P 4 ... 100 W
Ambient temperature	T _a (Module) - 10 ... + 50 °C
Dimensions	L x W x H = 95 x 40 x 32 mm

Emergency exit signs

Use	for information and escape sign fittings
Material	Foil, self-adhesive, printed with various pictograms in different colours
Mounting	Foil is stuck to cover externally
Options	The various types of adhesive foil which can be supplied are detailed in table "Accessories and Spare parts"
Recognition distance	e = 30 m
Dimensions	see dimensional drawings

E2













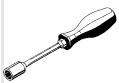



WWW.CABLEJOINTS.CO.UK
THORNE & DERRICK UK
TEL 0044 191 490 1547 FAX 0044 477 5371
TEL 0044 117 977 4647 FAX 0044 977 5582

Compact Light Fitting
Series C-LUX 6100 / 6500







WWW.CABLEJOINTS.CO.UK
THORNE & DERRICK UK
TEL 0044 191 490 1547 FAX 0044 477 5371
TEL 0044 117 977 4647 FAX 0044 977 5582

Accessories and Spare Parts

Designation	Illustration	Description	Order number	Weight kg		
Fluorescent lamps	 04936E00	8 W, \varnothing 16 mm, for two-pin G5 holder		0.000		
		Colour of light: cool white Light flux: 450 lm 10 pcs	119045	0.415		
Socket spanner	 05321E00	M8 / wrench size 13; to open/close the central locking	140486	0.126		
Adapter plate	 05756E00	for use together with metal cable glands; the metal cable glands are integrated in the earthing system via adapter plates				
		2 x M20 x 1.5	1 piece	115826	0.060	
		2 x M25 x 1.5	1 piece	115828	0.060	
Emergency exit sign		Adhesive foil: size: 150 x 355 mm recognition distance: e = 30 m Colour: white Symbol/Text: Background				
	 08483E00	white	green	1 pc	113182	0.015
	 08482E00	white	green	1 pc	113183	0.015
	 08484E00	white	green	1 pc	113184	0.015
	 08485E00	white	green	1 pc	113210	0.015
	 03206E00	green	white	1 pc	113193	0.015
	 12617E00	red	white	1 pc	113200	0.015
	 08486E00	white	green	1 pc	113211	0.015
	 09020E00	green	white	1 pc	113194	0.015
	 12618E00	red	white	1 pc	113201	0.015
	 08487E00	white	green	1 pc	113209	0.015
	 03203E00	green	white	1 pc	113192	0.015
	 12616E00	red	white	1 pc	113199	0.015

Accessories and Spare Parts

Designation	Illustration	Description	Order number	Weight kg
Emergency exit sign		Adhesive foil: size: 150 x 355 mm recognition distance: e = 30 m Colour: Symbol/Text Background		0.000
	 <small>08488E00</small>	white green 1 pc	113212	0.015
	 <small>12615E00</small>	green white 1 pc	113195	0.015
	 <small>12619E00</small>	red white 1 pc	113202	0.015
Diffuser	 <small>05704E00</small>	for light fitting 8 W	119044	0.250

E2

Dimensional Drawings (All Dimensions in mm) - Subject to Alterations

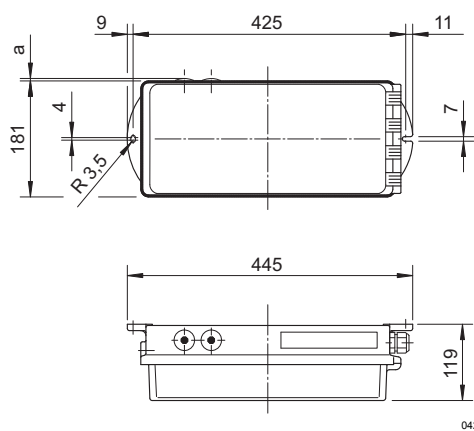

Additional dimensions for cable entries 8161 and plugs 8290

	a (mm)
8161 M25 x 1.5	32
8290 M25 x 1.5	6



Emergency exit sign

We reserve the right to make alterations to the technical data, dimensions, weights, designs and products available without notice. The illustrations cannot be considered binding.