



WWW.CABLEJOINTS.CO.UK  
THORNE & DERRICK UK  
TEL 0044 191 490 1547 FAX 0044 477 5371  
TEL 0044 117 977 4647 FAX 0044 977 5582  
WWW.THORNEANDDERRICK.CO.UK



Flexible cable  
sealing solutions  
for Ex applications

- GB** Ex Product catalogue
- IT** Catalogo prodotti Ex
- DE** Ex-Schutz Katalog
- ES** Catálogo de productos Ex
- FR** Catalogue Produits Ex

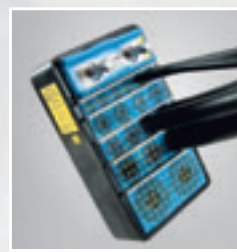
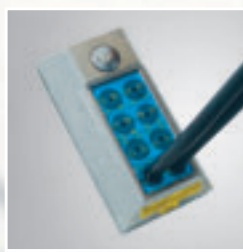
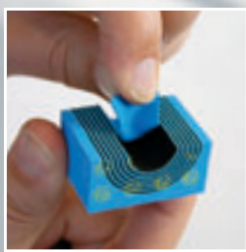





Certificates	9
Roxtec Ex information	10
Definitions	30

**Modules**

Roxtec RM Ex modules	34
Roxtec CM Ex modules	39

**Rectangular frames**

S Ex frame	43
SF...W Ex frame	49
G Ex frame	54
CF 8 Ex frame	60
CF 32 Ex frame	60
CF 16 Ex frame	62

**Round frames/seals**

R...W Ex frame	64
R...B Ex frame	64
RS...W Ex seal	69
RS...B Ex seal	69
C RS T Ex seal	74

**Assembly parts**

Roxtec Wedge Ex	76
Roxtec Stayplate Ex	79
Lubricant	81
Roxtec wedge clip	81

**Accessories**

Assembly/Disassembly Tools	82
Installation instructions	84

Guideline for selling Roxtec Explosion protected seals	85
--	----

**Ex EMC-solution**

Information regarding Ex EMC-solutions, please contact your local Roxtec supplier or e-mail [info@roxtec.com](mailto:info@roxtec.com) for guidance.

**All rights reserved**

We reserve the right to make changes to the product and technical information without further notice. Any errors in print or entry are no claims for indemnity. The content of this publication is the property of Roxtec International AB and is protected by copyright laws.



9	Certificati
14	Roxtec Ex
31	Definizioni

### Moduli

34	Moduli Roxtec RM Ex
39	Moduli Roxtec CM Ex

### Telai Rettangolari

43	Telai S Ex
49	Telai SF...W Ex
54	Telai G Ex
60	Telai CF 8 Ex
60	Telai CF 32 Ex
62	Telai CF 16 Ex

### Telai Circolari

64	Passaggi circolari R...W Ex
64	Passaggi circolari R...B Ex
69	Passaggi circolari RS...W Ex
69	Passaggi circolari RS...B Ex
74	Passaggi circolari C RS T Ex

### Parti di assemblaggio

76	Roxtec Wedge Ex
79	Piastre d'ancoraggio Roxtec Ex
81	Lubrificante
81	Clip per cuneo Roxtec

### Accessori

82	Accessori di assemblaggio/smontaggio
84	Istruzioni di Montaggio

### Soluzioni Ex-EMC

Per informazioni sulle versioni Ex-EMC  
Vi preghiamo di contattare la nostra  
sede Roxtec più vicina, o inviare una  
e-mail all'indirizzo [info@roxtec.com](mailto:info@roxtec.com).

### Tutti i diritti sono riservati .

Il contenuto di questa pubblicazione è di proprietà di Roxtec International AB ed è protetto da copyright. Ci riserviamo il diritto di effettuare modifiche e cambiamenti sui prodotti e sulle informazioni tecniche senza preavviso.



Certificate	9
Roxtec Ex-Schutz Informationen	18
Definitionen	32

**Modules**

Roxtec RM Ex module	34
Roxtec CM Ex module	39

**Rechteckige Rahmen**

S Ex Rahmen	43
SF...W Ex Rahmen	49
G Ex Rahmen	54
CF 8 Ex Rahmen	60
CF 32 Ex Rahmen	60
CF 16 Ex Rahmen	62

**Runde Rahmen/Abdichtungen**

R...W Ex Rahmen	64
R...B Ex Rahmen	64
RS...W Ex Stopfen	69
RS...B Ex Stopfen	69
C RS T Ex Stopfen	74

**Kompressionszubehör**

Roxtec Keildichtung Ex	76
Roxtec Ankerplatte Ex	79
Gleitmittel	81
Roxtec-Keildichtungsclip	81

**Zubehör**

Montage-/Demontage-Werkzeuge	82
Montage-Vorschriften	84

**Ex EMV-Lösungen**

Informationen und eine Beratung über Ex EMV Lösungen erhalten sie bei ihrer örtlichen Vertretung oder unter email [info@roxtec.com](mailto:info@roxtec.com).

**Alle Rechte vorbehalten**

Wir behalten uns das Recht vor, jederzeit Änderungen an dem Produkt oder den technischen Daten vorzunehmen. Druckfehler schließen Schadensersatzansprüche aus. Der Inhalt dieser Publikation ist Eigentum von Roxtec International AB und ist urheberrechtlich geschützt.



9	Certificado
22	Información Ex de Roxtec
32	Definiciones

### Módulos

34	Módulos RM Ex de Roxtec
39	Módulos CM Ex de Roxtec

### Marcos rectangulares

43	Marco S Ex
49	Marco SF...W Ex
54	Marco G Ex
60	Marco CF 8 Ex
60	Marco CF 32 Ex
62	Marco CF 16 Ex

### Marcos/sellos compactos

64	Sello R...W Ex
64	Sello R...B Ex
69	Sello RS...W Ex
69	Sello RS...B Ex
74	Sello C RS T Ex s

### Componentes de montaje

76	Unidad de compresión Roxtec Wedge Ex
79	Placa de separación Roxtec Stayplate Ex
81	Lubricante
81	Clip para unidad de compresión de Roxtec

### Accesorios

82	Herramientas de montaje/desmontaje
84	Instrucciones de montaje

### Solución EMC Ex.

Información referente a la solución EMC Ex. No dude en contactar con su distribuidor local Roxtec o envíe un e-mail a [info@es.roxtec.com](mailto:info@es.roxtec.com) para mayor orientación.

### Todos los derechos reservados

Reservado el derecho a realizar cambios en la información técnica y de producto sin previo aviso. Cualquier error de impresión o entrada no da derecho a reclamar indemnización. El contenido de esta publicación es propiedad de Roxtec International AB y está protegido con copyright.



Certificate	9
Roxtec Ex Information	26
Définitions	33

**Modules**

Modules RM Ex Roxtec	34
Modules CM Ex Roxtec	39

**Cadres rectangulaires**

Cadre S Ex	43
Cadre SF...W Ex	49
Cadre G Ex	54
Cadre CF 8 Ex	60
Cadre CF 32 Ex	60
Cadre CF 16 Ex	62

**Bagues cylindriques**

Bague R...W Ex	64
Bague R...B Ex	64
Bague RS...W Ex	69
Bague RS...B Ex	69
Bagues C RS T Ex seal	74

**Éléments de serrage et graisse**

Wedge Roxtec Ex	76
Plaques de maintien Roxtec Ex	79
Graisse	81
Le clip du coin Roxtec	81

**Accessoires**

Outils pour montage/démontage	82
Instructions de montage	84

**Solution Ex CEM**

Pour des informations concernant nos solutions Ex CEM, veuillez contacter votre distributeur local Roxtec ou bien par courriel [info@roxtec.com](mailto:info@roxtec.com) pour vous guider.

**Tous droits réservés**

Nous nous réservons le droit de faire des changements sur les produits et les informations techniques sans autre avertissement. Les éventuelles informations qui seraient erronées dans ce catalogue n'ouvrent aucun droit à des indemnités. Le contenu de cette publication est la propriété de Roxtec International AB et est protégé par droit d'auteur.

# Focusing on quality and sustainability

Roxtec is certified according to the quality standard ISO 9001 and the environmental standard ISO 14001. We are also certified according to the ATEX directive 94/9/EC and the international IECEx Quality system requirements.

Our Core Values inspire us to deliver first class products and services. In our work for continuous improvement, we are guided by our environmental policy, stating a wish to surpass applicable legislation on environmental issues.





# Product Certificates

**GB** Below is a list of all Roxtec Ex products and its ATEX and IECEx certificates.

**IT** Di seguito viene riportato un elenco di tutti i prodotti Roxtec Ex e dei relativi certificati ATEX e IECEx.

**DE** Es folgt eine Liste aller Roxtec Ex Produkte und ihrer ATEX und IECEx Zertifikate.

**ES** A continuación se proporciona una lista de todos los productos EX de Roxtec y sus certificados ATEX e IECEx.

**FR** Vous trouverez ci-dessous une liste de tous les produits Ex de Roxtec et leurs certificats ATEX et IECEx.

Frame/ Seal	Certificate Number	
C RS T Ex	SP08ATEX3913X	IECEX SP 09.0001X
RS...B Ex	SP08ATEX3914X	IECEX SP 09.0001X
RS...W Ex	SP08ATEX3915U	IECEX SP 09.0002U
CF 8 Ex	SP08ATEX3916X	IECEX SP 09.0001X
CF 32 Ex	SP08ATEX3916X	IECEX SP 09.0001X
CF 16 Ex	SP08ATEX3917X	IECEX SP 09.0001X
R...B Ex	SP08ATEX3918X	IECEX SP 09.0001X
R...W Ex	SP08ATEX3919U	IECEX SP 09.0002U
B...B Ex *	SP08ATEX3920X	IECEX SP 09.0001X
B...C Ex *	SP08ATEX3921U	IECEX SP 09.0002U
SF Ex *	SP08ATEX3922X	IECEX SP 09.0001X
G Ex	SP08ATEX3922X	IECEX SP 09.0001X
S Ex	SP08ATEX3923U	IECEX SP 09.0002U
SF...W Ex	SP08ATEX3924U	IECEX SP 09.0002U

- \* Available on request. Not published in the catalogue.
- \* Disponibile su richiesta. Non pubblicato nel catalogo.
- \* Verfügbar auf Anfrage. Nicht im Katalog veröffentlicht.
- \* Disponible a petición. No se publica en este catálogo.
- \* Disponible sur demande. Non publié au catalogue.

**GB**

# Roxtec approved for Ex e and Ex tD



The Roxtec Ex cable sealing system is certified according to the ATEX directive and the IECEx, International Certification Scheme, for use in areas where explosive atmospheres are likely to occur.

Roxtec Ex e products are designed to prevent ignition of explosive atmospheres. Typical applications are Ex e and/or Ex tD classified electrical enclosures, such as transformers, motors, generators and junction boxes.

The protection Ex e means increased safety, and the protection EX tD means protection by enclosure for explosive dust atmosphere.

**Some of the potential industries that are likely to be affected by the ATEX directive include:**

- Petro-chemical and chemical industries
- Mills, concrete plants
- Spray booth plants
- OEM producers intending to supply to areas where the ATEX product directive applies
- Silo works
- All other industries where areas have been zone classified according to marked areas in the chart below.

**Equipment not included under the ATEX product directive:**

- Seagoing vessels and mobile offshore units together with equipment on board such vessels or units, as they are already covered by the IMO Convention.  
*Note: Oil or gas platforms which are fixed are not excluded from the directive.*
- Medical devices intended for use in a medical environment.



Roxtec R 100 B Ex frame

**Areas, Zones, Groups and Categories**

Areas	Classification of explosion hazard	Required marking for electrical equipment	
		Equipment group	Category
Mining	Operating	I	M1
Mining	Shutdown	I	M2 or M1
Non-mining	Zone 0	II	1G
Non-mining	Zone 1	II	2G or 1G
Non-mining	Zone 2	II	3G, 2G or 1G
Non-mining	Zone 20	II	1D
Non-mining	Zone 21	II	2D or 1D
Non-mining	Zone 22	II	3D, 2D or 1D

Highlighted zones = Permitted zones for Roxtec Ex products

## Zone classification

Hazardous areas are classified into zones based on the possibility of occurrence of an explosive atmosphere.

It is the obligation of the owner or the operator of a facility to ensure that the zone classification is done by authorized personnel.

The Roxtec Ex product range includes a wide variety of seals to handle different cable sizes and openings. The products are designed and approved for use in Zone 1 and 2 for gas (incl vapour, mists) and 21 and 22 for dust. See figure, Zone classification.

Zone	
Zone 0 (gases)	Flammable material present continuously or for long periods
Zone 20 (dust)	
Zone 1 (gases)	Flammable material present occasionally in normal operation
Zone 21 (dust)	
Zone 2 (gases)	Flammable material present in abnormal conditions only for short periods
Zone 22 (dust)	

Highlighted zones = Permitted zones for Roxtec Ex products

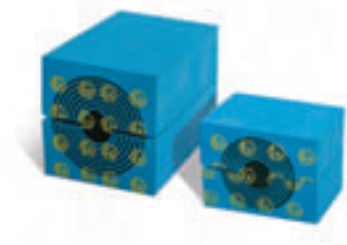

## The ATEX directive

Directive 94/9/EC is commonly referred to as the ATEX ("Atmosphères Explosibles") products directive. Its objective is to eliminate or minimize the risks resulting from the use of certain products in or in relation to a potentially explosive atmosphere.

The ATEX product directive is a total harmonization directive meaning that its provisions replace existing

divergent national and European legislation which cover the same subjects as stipulated by the ATEX product directive.

The ATEX products directive applies in the countries of the European Union as well as in Liechtenstein, Iceland and Norway.

### Standards

Roxtec Ex products are tested, approved and certified according to the following standards:

EN 60079-0:2006  
 EN 60079-7:2003  
 EN 61241-0:2006  
 EN 61241-1:2004  
 IEC 60079-0:2004  
 IEC 60079-7:2001  
 IEC 61241-0:2006  
 IEC 61241-1:2004

## IECEx, International Certification Scheme

The IECEx certification scheme simplifies global trade with, as well as maintenance of, equipment intended for use in explosive atmospheres. The IECEx scheme is voluntary. It is managed by the IEC, a standardization organization, and based on

global acceptance of test reports by the member states.

Certification is based on requirements in specific international IEC standards for explosion protected equipment.

# Reduction of risk with Roxtec

The purpose of the Roxtec Ex products is to minimize the risk of an explosion to occur.

## What is an explosive atmosphere?

An explosive atmosphere is defined as a mixture of air and a flammable substance in the form of gases, vapours, mists, dusts or fibers, in which, after ignition, combustion spreads throughout the entire unconsumed mixture.

Potential sources of ignition include hot surfaces, electrical sparks, open flames and mechanical friction sparks.

## What is an explosion?

An explosion is a sudden chemical reaction of a flammable material with oxygen. In order for an explosion to occur, three conditions must be fulfilled:

- 1: Flammable material
- 2: Oxygen
- 3: Ignition source

*fire, sparks or hot surfaces*

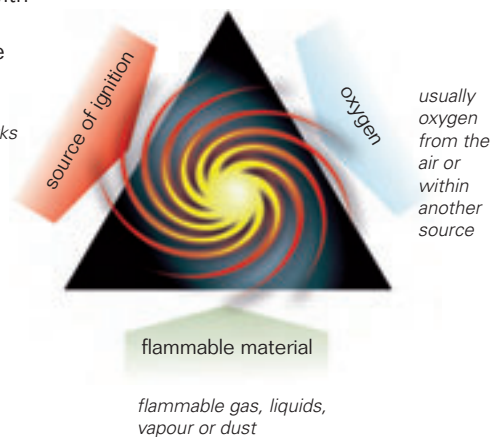

## Risk reduction in general

In all situations where there may be an explosive atmosphere, the following steps should be taken to minimize the risk of explosion:

- Elimination of the explosive atmosphere around the source of ignition
- Elimination of the source of ignition
- Substitute with a non-flammable substance
- Lowering the process temperature

In practice, however, it is very difficult to ensure that an explosive atmosphere will never occur.

In these cases the ATEX products directive provides necessary protective measures.

# Roxtec Ex marking

All Roxtec Ex products are clearly marked in accordance with the ATEX directive. They are easily identified by the yellow Ex label and Ex icon.

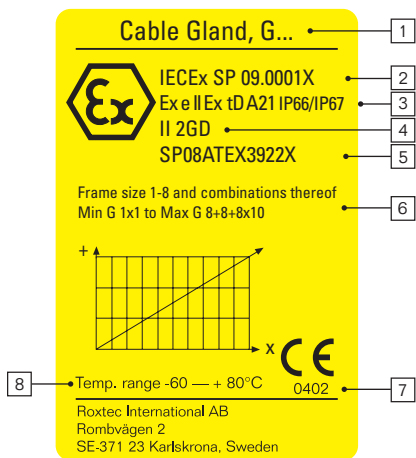

1. Type of gland (cable seal).
2. IECEx certificate number.  
**U** = Marking to indicate that the equipment is an Ex component.  
**X** = Marking to indicate that special conditions for safe use apply for the certification of the product.
3. **Ex e II** = Marking for protection against potential explosive gases.  
**Ex** = The symbol to indicate that the electrical apparatus corresponds with one or more explosion protection techniques.  
**e** = The symbol for each type of protection techniques used. "e" is increased safety.  
**II** = The group of electrical apparatus.  
**Ex tD** = Marking for protection against potential explosive dust. Protected by enclosure.  
**A21** = The equipment is intended to be placed in zone 21 and 22 (not in zone 20).  
**IP66/IP67** = IP code (Ingress Protection)
4. **II** = The equipment group of electrical apparatus.  
**2 GD** = The equipment (or Ex component) fulfills requirements for category 2 for both explosive gas (G) atmosphere and explosive dust (D) atmosphere according to the ATEX directive.
5. **SP** = Name or mark of notified body.  
**08** = Year of certification.  
**3922, 3919** = Consecutive No.  
**U** = Marking to indicate that the equipment is an Ex component.  
**X** = Marking to indicate that special conditions for safe use apply for the certification of the product.
6. Type designation for the certified cable gland.
7. **0402** = Serial number of notified body.
8. Minimum/Maximum ambient temperature.
9. For cable glands certified as apparatus according to the ATEX directive, the CE mark is also applied.

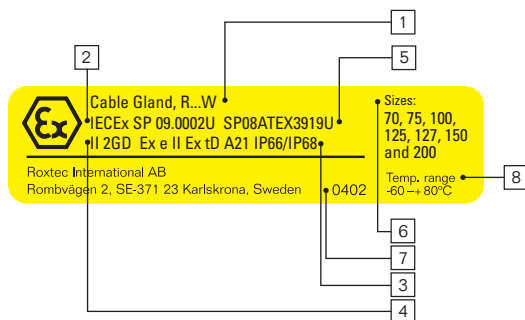

# IT Roxtec approvato per Ex e e Ex tD



Il sistema di sigillatura Ex per cavi Roxtec è certificato secondo la direttiva ATEX e normative internazionali IECEx, per l'impiego in aree dove possono formarsi atmosfere esplosive.

I prodotti Roxtec Ex sono progettati per prevenire l'innesco di un'esplosione. Le applicazioni tipiche sono i locali, i cabinet e le carpenterie elettriche classificate Ex-e ed Ex-tD, i trasformatori, i motori elettrici nonché le cassette di derivazione.

La dicitura "Ex-e" indica una protezione a "sicurezza aumentata" mentre la dicitura "Ex-tD" indica la protezione per atmosfere con presenza di polveri potenzialmente esplosive.

## Tra le industrie che potrebbero essere soggette alle normative ATEX troviamo:

- Industria chimica e petrol-chimica
- Cementifici
- Produttori di macchinari per applicazioni in aree dove sono applicate le norme ATEX
- Silos, Mulini
- Tutte quelle industrie che rientrano nella classificazione di Zone come indicato nella tabella in alto.

## Apparecchiature non sottoposte alle direttive ATEX

- Imbarcazioni e unità offshore mobili, comprese le apparecchiature a bordo, che sono già coperte dalla convenzione IMO  
*N.B.: Piattaforme petrolifere fisse non sono escluse dalla direttiva ATEX.*
- Apparecchiature mediche.



Telaio Roxtec R100 B Ex

## Area, Zone, Gruppi e Categorie

Aree	Classificazione dei rischi di esplosione	Marchiature richieste per le apparecchiature elettriche	
		Gruppo apparecchiature	Categoria
Attività minerarie	Operative	I	M1
Attività minerarie	Shutdown	I	M2 o M1
Attività non minerarie	Zona 0	II	1G
Attività non minerarie	Zona 1	II	2G o 1G
Attività non minerarie	Zona 2	II	3G, 2G o 1G
Attività non minerarie	Zona 20	II	1D
Attività non minerarie	Zona 21	II	2D o 1D
Attività non minerarie	Zona 22	II	3D, 2D o 1D

Parti colorate = aree adatte per i prodotti Roxtec Ex

## Classificazione zone

Le aree pericolose sono classificate in zone in base alla possibilità di innescare un'esplosione. È fatto obbligo al proprietario o all'operatore di un impianto, di assicurarsi che la classificazione in zone venga fatta da personale autorizzato.

La gamma dei prodotti Roxtec Ex include un'ampia varietà di soluzioni, per gestire diverse misure di cavi ed aperture. I prodotti Roxtec sono progettati ed approvati per Zona 1 e Zona 2 per gas (compresi i vapori e le nebbie industriali) e per le Zone 21 e 22 per le polveri. Vedi tabella classificazioni aree.

Zone	
Zona 0 (gas)	Materiale infiammabile presente continuamente o per lunghi periodi
Zona 20 (polvere)	
Zona 1 (gas)	Materiale infiammabile presente di tanto in tanto in condizioni normali
Zona 21 (polvere)	
Zona 2 (gas)	Materiale infiammabile presente in condizioni anormali soltanto per brevi periodi
Zona 22 (polvere)	

Parti colorate = aree adatte per i prodotti Roxtec Ex



## La Direttiva ATEX

La direttiva 94/9/CE è comunemente citata come direttiva prodotti ATEX ("Atmosphère Explosibles"). Il suo obiettivo è eliminare o ridurre al minimo il rischio derivante dall'utilizzo di alcuni prodotti in o in relazione di ambienti esplosivi.

Quella ATEX è una direttiva globale che si prefigge di sostituire tutte le normative nazionali ed europee

esistenti, coprendo gli stessi argomenti.

La direttiva ATEX è applicata nei paesi dell'Unione Europea così come in Islanda, Norvegia e Liechtenstein.

### Standard

I prodotti Roxtec Ex sono collaudati, approvati e certificati in accordo ai seguenti standard:

EN 60079-0:2006  
 EN 60079-7:2003  
 EN 61241-0:2006  
 EN 61241-1:2004  
 IEC 60079-0:2004  
 IEC 60079-7:2001  
 IEC 61241-0:2006  
 IEC 61241-1:2004

## Certificazioni internazionali IECEx

Le Certificazioni internazionali IECEx semplificano non solo il commercio globale ma anche la manutenzione di apparecchiature destinate all'uso in atmosfere esplosive.

L'applicazione delle Normative IECEx è facoltativa ed è regolata dalla IEC, un'organizzazione che si occupa di standardizzazione, la cui

attività è basata sull'accettazione globale dei test da parte degli stati membri.

La certificazione si basa sui requisiti previsti dalle specifiche Normative internazionali IEC per le apparecchiature protette contro le esplosioni.

# Riduzione dei rischi con Roxtec

L'obiettivo dei prodotti Roxtec Ex è ridurre al minimo la possibilità che accada un'esplosione.

## Che cosa è una atmosfera esplosiva?

Un'atmosfera esplosiva è definita come un composto di aria e sostanze infiammabili (sotto forma di gas, vapori, polveri o fibre), nel quale, dopo l'accensione, la combustione si estende attraverso l'intero composto non consumato.

Potenziali fonti di accensione sono: superfici calde, scintille elettriche, fiamme libere e scintille da frizione meccanica.

## Che cosa è una esplosione?

Un'esplosione è una reazione chimica accidentale tra un materiale infiammabile e l'ossigeno. Affinché avvenga un'esplosione sono tre le condizioni che devono verificarsi:

- 1: materiale infiammabile
- 2: ossigeno
- 3: fonte di accensione

*fuoco,  
scintille o  
superfici  
calde*

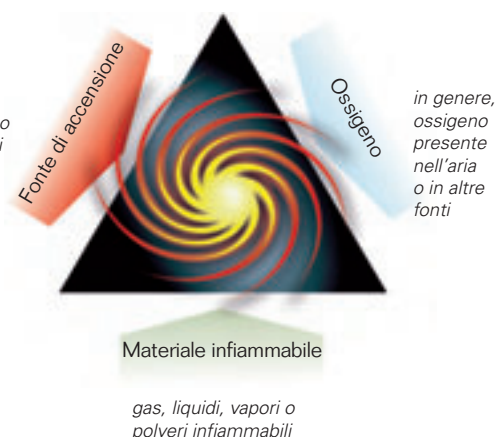

## Riduzione dei rischi in generale

In tutte le situazioni dove sono presenti delle atmosfere esplosive, dovrebbero essere prese le seguenti precauzioni al fine di minimizzare il rischio di esplosione:

- Eliminazione del composto esplosivo attorno alla fonte di accensione
- Eliminazione delle fonti di accensione
- Utilizzo sostanze non infiammabili
- Riduzione la temperatura d'esercizio

In pratica, comunque, è molto difficile garantire che un'esplosione non avvenga mai.

In questi casi la direttiva ATEX provvede alle necessarie misure di protezione.



# La marchiatura Ex Roxtec

Tutti i prodotti Roxtec Ex sono chiaramente marchiati secondo la direttiva ATEX. I prodotti Roxtec Ex sono facilmente identificati da una etichetta gialla e dal logo Ex.

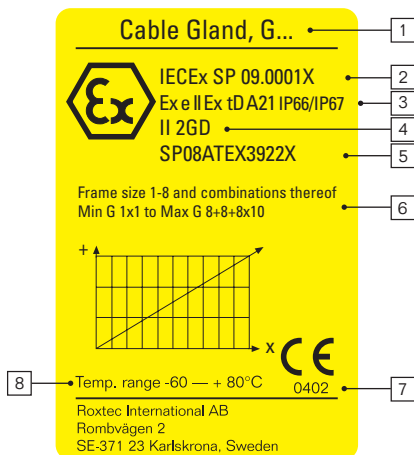

1. Tipo di pressacavo (con guarnizione e tipo di isolamento del cavo)
2. Numero del certificato IECEx.  
**U** = indica che l'apparecchiatura è un componente Ex.  
**X** = indica che per la certificazione del prodotto è necessario che vengano applicate condizioni speciali per garantire un utilizzo sicuro.
3. **Ex e II** = indicano la protezione contro gas potenzialmente esplosivi.  
**Ex** = Simbolo per indicare che l'apparato elettrico corrisponde ad uno o più metodi di protezione all'esplosione.  
**e** = Simbolo per ciascun metodo di protezione utilizzato. "e" indica "sicurezza aumentata".  
**II** = Gruppo dell'apparato elettrico.  
**Ex tD** = indica protezione con custodia per atmosfere con polveri esplosive.  
**A21** = indica che l'apparecchio è progettato per essere collocato nelle zone 21 e 22 (non nella zona 20).  
**IP66/IP67** = Categoria IP (Ingress Protection).
4. **II** = indica il gruppo delle apparecchiature elettriche.  
**2 GD** = indica che l'apparecchiatura (o il componente Ex) soddisfa entrambi i requisiti per la zona 2 per esplosivi (G) e per l'atmosfera di polveri esplosive (D) in conformità con la direttiva ATEX.
5. **SP** = Nome dell'ente certificatore.  
**08** = Anno della certificazione.  
**3922, 3919** = Nr. consecutivo.  
**U** = indica che l'apparecchiatura è un componente Ex.  
**X** = indica che per la certificazione del prodotto è necessario che vengano applicate condizioni speciali per garantire un utilizzo sicuro.
6. Tipo di indicazione per il pressacavo certificato.
7. **0402** = Numero seriale dell'ente certificatore.
8. Minimum/Maximum ambient temperatur.
9. Il marchio CE si applica anche nel caso di pressacavi certificati in accordo alla direttiva ATEX.

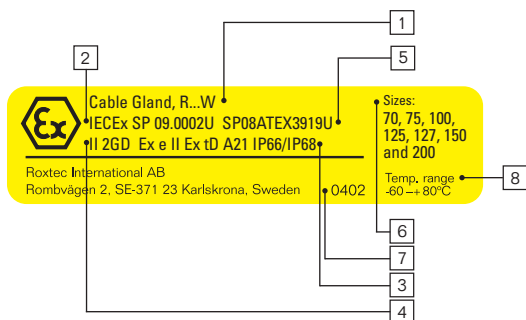

# Roxtec Ex e und Ex tD zugelassen



Das Roxtec Ex Kabeldurchführungssystem ist nach der ATEX Richtlinie und dem internationalen Zertifizierungsschema IECEx zertifiziert und für den Einsatz in potentiell explosiven Atmosphären vorgesehen.

Die Roxtec Ex e Produkte sind dafür ausgelegt, die Entzündung explosiver Atmosphären zu verhindern. Typische Anwendungen sind Ex e-klassifizierte elektrische Gehäuse, Transformatoren, Motoren, Generatoren und Verteilerkästen.

Ex e bedeutet Schutz durch erhöhte Sicherheit, und EX tD bedeutet Schutz durch Gehäuse in explosionsfähigen Staubatmosphären.

## Einige potentielle Industriezweige, die mit großer Wahrscheinlichkeit von der ATEX-Richtlinie betroffen sind:

- Petrochemische und chemische Industrie
- Mühlen, Betonwerke
- Spritzereien
- OEM-Hersteller, die beabsichtigen, in Bereiche zu liefern, in denen die ATEX-Produktrichtlinie gilt
- Silowerke
- Alle anderen Industriezweige, in denen es Bereiche gibt, die nach den Zonen der oben stehenden Tabelle klassifiziert sind.

## Betriebsmittel, die nicht unter die ATEX-Produktrichtlinie fallen

- Seeschiffe und mobile Offshore-Einheiten, einschließlich der Ausrüstung an Bord solcher Schiffe oder Einheiten, da diese bereits durch die IMO-Konvention abgedeckt sind.  
*Bitte beachten: Feststehende Öl- oder Gasbohrinseln sind von der Richtlinie nicht ausgenommen.*
- Für den Gebrauch in medizinischen Umgebungen bestimmte medizinische Geräte.



Roxtec R 100 B Ex Rahmen

## Bereich, Zonen, Gruppen und Kategorien

Bereiche	Klassifikation der Explosionsgefahr	Erforderliche Kennzeichnung der elektrischen Betriebsmittel	
		Betriebsmittelgruppe	Kategorie
Bergbau	Betrieb	I	M1
Bergbau	Stilllegung	I	M2 oder M1
Nicht-Bergbau	Zone 0	II	1G
Nicht-Bergbau	Zone 1	II	2G oder 1G
Nicht-Bergbau	Zone 2	II	3G, 2G oder 1G
Nicht-Bergbau	Zone 20	II	1D
Nicht-Bergbau	Zone 21	II	2D oder 1D
Nicht-Bergbau	Zone 22	II	3D, 2D oder 1D

Hervorgehobene Zonen = Zonen, in denen Roxtec Ex-Schutz-Produkte zugelassen sind

## Zoneneinteilung

Gefährliche Bereiche sind nach Zonen klassifiziert, basierend auf der Möglichkeit des Auftretens einer explosiven Atmosphäre.

Der Besitzer oder Betreiber einer Anlage ist verpflichtet, sicherzustellen, dass die Zonenklassifikation durch autorisiertes Personal erfolgt.

Die Roxtec Ex-Schutz-Produktpalette umfasst eine Vielzahl von Durchführungen zur Handhabung verschiedener Kabelgrößen und Öffnungen. Die Produkte sind ausgelegt und zugelassen für die Verwendung in Zone 1 und 2 für Gas (einschl. Dampf, Nebel) und 21 und 22 für Staub. Siehe Abbildung, Zoneneinteilung.

Zone	
Zone 0 (Gase)	Entflammables Material, das ständig oder über längere Zeiträume
Zone 20 (Staub)	vorhanden ist
Zone 1 (Gase)	Entflammables Material, das bei Betrieb gelegentlich vorhanden ist
Zone 21 (Staub)	
Zone 2 (Gase)	Entflammables Material, das nur unter außergewöhnlichen Bedingungen
Zone 22 (Staub)	und nur für kurze Zeit vorhanden ist

Hervorgehobene Zonen = Zonen, in denen Roxtec Ex-Schutz-Produkte zugelassen sind



## Die ATEX Richtlinie

Die Richtlinie 94/9/EG wird im Allgemeinen als die ATEX ("Atmosphères Explosibles")-Produktrichtlinie bezeichnet. Ihr Ziel besteht darin, die Gefahren zu eliminieren oder zu minimieren, die durch die Verwendung bestimmter Produkte in einer potentiell explosiven Atmosphäre oder in Verbindung damit entstehen.

Die ATEX-Produktrichtlinie ist eine komplette Harmonisierungsrichtlinie,

deren Bestimmungen bestehende, voneinander abweichende nationale und europäische Gesetze ersetzen, die den gleichen Gegenstand betreffen, wie er von der ATEX-Produktrichtlinie festgelegt ist.

Die ATEX-Produktrichtlinie findet Anwendung in den Ländern der Europäischen Union, in Liechtenstein, Island und Norwegen.

### Standards

Roxtec Ex Produkte sind nach folgenden Normen geprüft, genehmigt und zertifiziert:

EN 60079-0:2006  
 EN 60079-7:2003  
 EN 61241-0:2006  
 EN 61241-1:2004  
 IEC 60079-0:2004  
 IEC 60079-7:2001  
 IEC 61241-0:2006  
 IEC 61241-1:2004

## IECEx, Internationales Zertifizierungsschema

Das IECEx Zertifizierungsschema vereinfacht den globalen Handel mit Betriebsmitteln für den Einsatz in explosiven Atmosphären und deren Wartung. Zertifizierungen nach dem IECEx Schema erfolgen auf freiwilliger Basis. Das Schema wird vom internationalen Normungsgremium IEC gemanagt

und basiert auf der weltweiten Akzeptanz von Prüfberichten der Mitgliedstaaten.

Die Zertifizierung basiert auf den Anforderungen spezifischer internationaler IEC-Normen für explosionsgeschützte Betriebsmittel.

# Gefahrenminderung mit Roxtec

Roxtec Ex-Schutz-Produkte minimieren die Explosionsgefahr.

## Was ist eine explosive Atmosphäre?

Eine explosive Atmosphäre ist definiert als ein Gemisch aus Luft und einem entflammaren Stoff in Form von Gasen, Dämpfen, Nebeln oder Stäuben, in dem sich nach einer Zündung der Verbrennungsvorgang auf das gesamte unver-

brannte Gemisch überträgt.

Potentielle Zündquellen:  
Heiße Oberflächen, elektrische Funken, offene Flammen und mechanische Reibungsfunken.

## Was ist eine Explosion?

Eine Explosion ist eine plötzliche chemische Reaktion von entflammarem Material mit Sauerstoff. Damit eine Explosion ausgelöst wird, müssen drei Bedingungen erfüllt sein:

- 1: Entflammables Material
- 2: Sauerstoff
- 3: Zündquelle

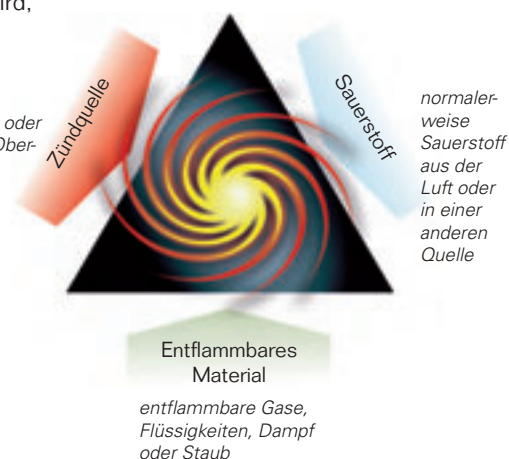

## Gefahrenminderung im Allgemeinen

In allen Situationen, in denen sich eine explosive Atmosphäre bilden kann, sollten die folgenden Maßnahmen ergriffen werden, um die Explosionsgefahr zu minimieren:

- Eliminierung der explosiven Atmosphäre um die Zündquelle herum
- Eliminierung der Zündquelle
- Ersatz durch einen nichtentflammaren Stoff
- Verminderung der Prozesstemperatur

In der Praxis ist es jedoch sehr schwierig, die Entstehung einer explosiven Atmosphäre auszuschließen.

In diesen Fällen gibt die ATEX-Produktrichtlinie die nötigen Schutzmaßnahmen vor.

# Roxtec Ex-Kennzeichnung

Sämtliche Roxtec Ex-Schutz-Produkte sind gemäß der Richtlinie eindeutig gekennzeichnet. Die Roxtec Ex-Schutz-Produkte sind leicht an den gelben Ex-Kennzeichnungen und dem Ex-Symbol zu erkennen.

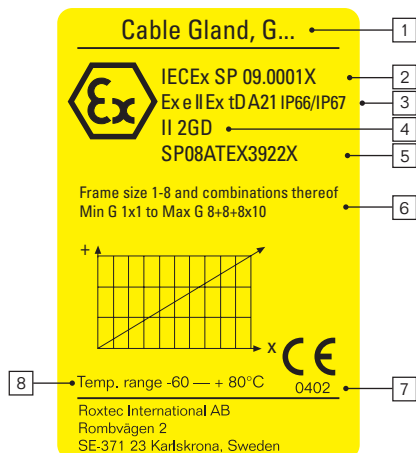

1. Typ der Kabelverschraubung (Kabeldichtung).
2. IECEx Zertifikatnummer.  
**U** = Kennzeichnung, die anzeigt, dass das Betriebsmittel eine Ex Komponente ist.  
**X** = Kennzeichnung, die anzeigt, dass für die Zertifizierung des Produkts besondere Bedingungen für den sicheren Gebrauch gelten.
3. **Ex e II** = Kennzeichnung für den Schutz vor potentiell explosiven Gasen.  
**Ex** = Symbol zeigt an, dass das Betriebsmittel gemäß einer oder mehrerer Explosionschutztechniken ausgeführt ist.  
**e** = Symbol für die jeweils angewendete Explosionsschutztechnik "e" bedeutet erhöhte Sicherheit.  
**II** = Gruppe der elektrischen Betriebsmittel  
**Ex tD** = Kennzeichnung für den Schutz vor potentiell explosivem Staub. Schutz durch Gehäuse.  
**A21** = Die Betriebsmittel sind für die Zonen 21 und 22 (nicht für Zone 20) vorgesehen.  
**IP66/IP67** = IP-Klasse (Eindringenschutz)

4. **II** = Betriebsmittelgruppe elektrischer Geräte.  
**2 GD** = Das Betriebsmittel (oder Ex Komponente) erfüllt die Anforderungen für Kategorie 2 sowohl für Atmosphären mit explosiven Gasen (G) als auch für Atmosphären mit explosivem Staub (D) nach der ATEX Richtlinie.
5. **SP** = Name oder Zeichen der gemeldeten Stelle  
**08** = Jahr der Zertifizierung  
**3922, 3919** = Seriennummer  
**U** = Kennzeichnung, die anzeigt, dass das Betriebsmittel eine Ex Komponente ist.  
**X** = Kennzeichnung, die anzeigt, dass die Zertifizierung des Produkts besondere Bedingungen für die sichere Anwendung erfordert.
6. Typenbezeichnung für die zertifizierte Kabelverschraubung
7. **0402** = Seriennummer der gemeldeten Stelle
8. Minimale/Maximale Umgebungstemperatur
9. Für Kabelverschraubungen, die nach der ATEX Richtlinie als Geräte zertifiziert sind, wird die CE Kennzeichnung ebenfalls angewendet.

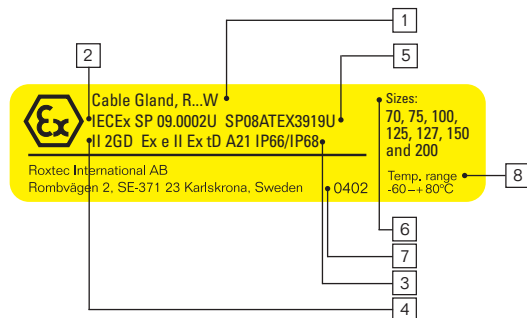

# Roxtec está certificado para Ex e y Ex tD

El sistema de sellado de cables Ex de Roxtec está certificado según la directiva ATEX y por IECEx (International Certification Scheme) para uso en atmósferas potencialmente explosivas.

Los productos Ex e de Roxtec están diseñados para prevenir la ignición en atmósferas explosivas. Las aplicaciones clasificadas como Ex e más comunes son: armarios eléctricos, transformadores, motores, generadores y cajas de empalme.

La protección Ex e significa un incremento en la seguridad y la protección EX tD indica envolvente antideflagrante para atmósferas explosivas causadas por polvo.

## Algunas de las industrias potenciales que pueden verse afectadas por la directiva ATEX son:

- Industria química y petroquímica
- Molinos, plantas de hormigón
- Plantas de cabinas de vaporización
- Productores OEM con intención de suministrar su producto en áreas donde la directiva de producto ATEX es aplicable.
- Silos
- Todo el resto de industrias que han sido clasificadas por zonas según las áreas remarcadas en el cuadro superior.

## Equipos no incluidos en la directiva de productos ATEX

- Embarcaciones de altura y unidades móviles offshore con equipos a bordo, dado que ya están cubiertos por la Convención IMO

*Tenga en cuenta que las plataformas petrolíferas o gaseras fijas no están excluidas en la directiva.*

- Equipos médicos que se van a utilizar en un entorno médico.



Marco R 100 B Ex de Roxtec

## Zonas, grupos y categorías

Áreas	Clasificación del riesgo de explosión	Etiquetado requerido para los equipos eléctricos	
		Grupo de equipos	Categoría
Minera	Operativo	I	M1
Minera	Apagado	I	M2 o M1
No minero	Zona 0	II	1G
No minero	Zona 1	II	2G o 1G
No minero	Zona 2	II	3G, 2G o 1G
No minero	Zona 20	II	1D
No minero	Zona 21	II	2D o 1D
No minero	Zona 22	II	3D, 2D o 1D

Zonas resaltadas = Zonas permitidas para los productos Ex de Roxtec

# Clasificación de zonas

Las áreas peligrosas están clasificadas en zonas según la posibilidad de concurrencia de una atmósfera explosiva.

Es obligación del propietario o del operario de un centro asegurarse de que la clasificación de la zona es realizada por personal autorizado.

La gama de productos Ex e de Roxtec incluye una amplia variedad de sellos que abarcan diversos tamaños de cables y huecos. Los productos están diseñados y aprobados para su uso en Zona 1 y 2 para Gas (incl vapor, vaho) y 21 y 22 para Polvo. Véase el cuadro Clasificación de las zonas.

Zona	
Zona 0 (Gases)	Material inflamable continuamente presente o durante largos periodos.
Zona 20 (Polvo)	
Zona 1 (Gases)	Material inflamable presente de vez en cuando en uso normal
Zona 21 (Polvo)	
Zona 2 (Gases)	Material inflamable presente en condiciones excepcionales y sólo durante breves periodos.
Zona 22 (Polvo)	

Zonas resaltadas = Zonas permitidas para los productos Ex de Roxtec

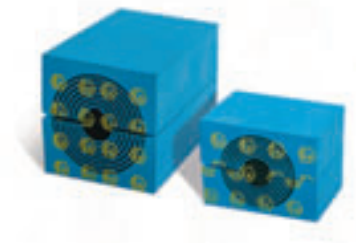

## La directiva ATEX

La Directiva 94/9/EC es comúnmente denominada directiva de productos ATEX ("Atmósferas Explosivas"). Su objetivo es eliminar o minimizar los riesgos resultantes del uso de ciertos productos en o en relación con una atmósfera explosiva.

La directiva de producto ATEX es una directiva de coordinación total, lo que se refleja en que sus disposiciones reemplazan las dife-

rentes leyes nacionales y europeas divergentes que cubren los mismos aspectos estipulados por la directiva de producto ATEX.

La directiva de producto ATEX afecta a los países de la Unión Europea, así como Liechtenstein, Islandia y Noruega.

### Estándares

Los productos Ex de Roxtec están comprobados, aprobados y certificados según los estándares siguientes:

- EN 60079-0:2006
- EN 60079-7:2003
- EN 61241-0:2006
- EN 61241-1:2004
- IEC 60079-0:2004
- IEC 60079-7:2001
- IEC 61241-0:2006
- IEC 61241-1:2004

## IECEx, International Certification Scheme

El certificado IECEx simplifica el comercio global de equipos diseñados para uso en atmósferas explosivas, así como su mantenimiento. La aprobación IECEx es de carácter voluntario. La gestiona el IEC, una organización de estandarización, y se basa en la aceptación global de los informes

de pruebas sometidos por los estados miembros.

La certificación se basa en requisitos de estándares internacionales específicos del IEC para equipos protegidos contra explosiones.

# Reducción del riesgo con Roxtec

El propósito de los productos Ex e de Roxtec es minimizar el riesgo de que se dé una explosión.

## ¿Qué es una atmósfera explosiva?

Una atmósfera explosiva se define como una mezcla de aire con una sustancia inflamable en forma de gases, vapores, vahos, nieblas o fibras en las que, tras la ignición, la combustión se expande por toda la mezcla no consumida.

Son fuentes potenciales de ignición: Superficies calientes, chispas eléctricas, chispas resultantes de la fricción mecánica o de llamas.

## ¿Qué es una explosión?

Una explosión es la reacción química espontánea de un material inflamable con oxígeno. Para que se produzca una explosión tienen que cumplirse tres condiciones:

- 1: Material inflamable
- 2: Oxígeno
- 3: Fuente de ignición

*fuego,  
chispas o  
superficies  
calientes*

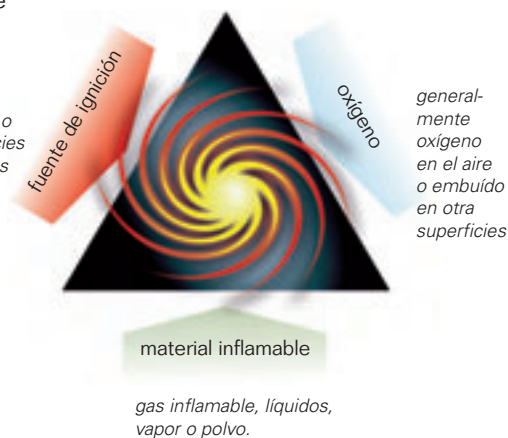

## Reducción del riesgo en general

En todas las situaciones en las que puede darse una atmósfera explosiva, deben seguirse los siguientes pasos para minimizar el riesgo de una explosión:

- Eliminar la atmósfera explosiva en los alrededores de la fuente de ignición.
- Eliminar la fuente de ignición
- Sustituirla por una sustancia no inflamable
- Bajar la temperatura del proceso

Sin embargo, en la práctica es muy difícil asegurar que nunca se dará una atmósfera explosiva.

En dichos casos, la directiva de productos ATEX proporciona las medidas de protección necesarias.



# Etiquetado Ex de Roxtec

Todos los productos Ex de Roxtec están claramente etiquetados conforme a la Directiva ATEX. Los productos Ex de Roxtec están claramente identificados por las etiquetas amarillas Ex y el símbolo Ex.

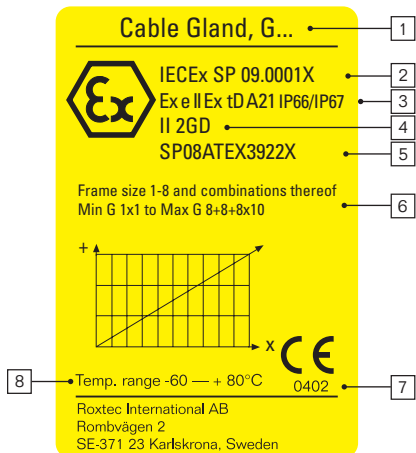

1. Tipo de casquillo (sello para cable).
2. Número de certificado IECEx.
3. Ex e II = Marca que indica protección contra gases potencialmente explosivos.
4. II = Grupo de equipos de aparatos eléctricos.
5. SP = Nombre o marca del organismo notificado
6. 08 = Año de certificación
7. 3922, 3919 = N° consecutivo
8. U = Marca que indica que el equipo es un componente Ex.
9. X = Marca que indica que la certificación del producto requiere de condiciones especiales para un uso seguro.

4. II = Grupo de equipos de aparatos eléctricos.
- 2 GD = El equipo (o componente Ex) satisface los requisitos de la categoría 2, tanto para atmósferas de gases explosivos (G) como de polvos explosivos (D) de acuerdo a la directiva ATEX.
5. SP = Nombre o marca del organismo notificado
- 08 = Año de certificación
- 3922, 3919 = N° consecutivo
- U = Marca que indica que el equipo es un componente Ex.
- X = Marca que indica que la certificación del producto requiere de condiciones especiales para un uso seguro.
6. Tipo de identificación para sellos certificados
7. 0402 = Número de serie del organismo notificado
8. Temperatura ambiente mínima/máxima
9. Para sellos certificados como aparatos según la directiva ATEX, también se incluye la marca CE.

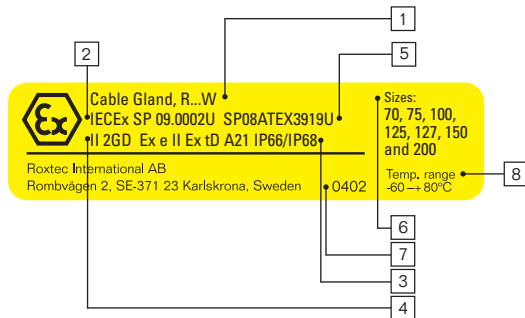

# Roxtec est certifié Ex e et Ex tD



Le système d'étanchéité pour câbles Ex de Roxtec est certifié conforme à la directive ATEX et à l'IECEX, schéma de certification international, pour une utilisation dans des zones où des atmosphères explosibles sont susceptibles de se produire.

Les solutions Roxtec Ex e sont conçues pour prévenir toute inflammation des atmosphères explosibles. Les applications types sont les enveloppes électriques classées Ex e, transformateurs, moteurs, générateurs, et boîtes de jonction.

La protection Ex e signifie une sécurité renforcée tandis que la protection EX tD implique une protection par armoire pour les atmosphères à poussières explosibles.

## Quelques exemples d'industries qui peuvent être concernées par la Directive ATEX :

- Industries chimiques et pétrochimiques
- Silos, cimenteries
- Cabines de peintures
- Fabricants OEM pour des équipements mis dans des zones où s'applique la Directive Atex
- Toutes les autres industries où des zones ont été classées selon le tableau décrit plus haut.

## Equipements ne faisant pas partie de la Directive Atex :

- Navires et unités mobiles offshore ainsi que les équipements embarqués à bord, puisqu'ils sont déjà couverts par la Convention IMO.  
*Notez que : les plateformes pétrolières et gazières fixes ne sont pas exclues de la Directive.*
- Equipements médicaux installés dans un environnement médical.



Bague Roxtec R 100 B Ex

## Zones, groupes, catégories

Zones	Classification de la zone dangereuse	Marquage requis pour l'équipement électrique	
		Groupe de matériel	Catégorie
Mine	Opérationnel	I	M1
Mine	Court circuit	I	M2 ou M1
Non-mining	Zone 0	II	1G
Non-mining	Zone 1	II	2G ou 1G
Non-mining	Zone 2	II	3G, 2G ou 1G
Non-mining	Zone 20	II	1D
Non-mining	Zone 21	II	2D ou 1D
Non-mining	Zone 22	II	3D, 2D ou 1D

Zones grisées : zones permises pour les produits Roxtec Ex

## Classification des zones

Les zones dangereuses sont classées selon la possibilité d'apparition d'une atmosphère explosible. Il est de la responsabilité du pro-priétaire ou du responsable d'une installation de s'assurer que la classification par zones a été effectuée par les personnes dûment habilitées.

La gamme de produits Roxtec Ex e comprend une grande variété de solutions étanches pour différents câbles et trémies. Les produits sont conçus et approuvés en Zone 1 et 2 pour le gaz (y compris la vapeur, brumes) et 21 et 22 pour la poussière. Se reporter au tableau ci-contre, classification en zones.

Zone	
Zone 0 (gaz)	Matériel inflammable présent en permanence ou sur de longues périodes
Zone 20 (poussières)	
Zone 1 (gaz)	Matériel inflammable présent occasionnellement en mode normal de fonctionnement
Zone 21 (poussières)	
Zone 2 (gaz)	Matériel inflammable présent dans des conditions anormales seulement sur de courtes périodes
Zone 22 (poussières)	

Zones grisées = zones permises pour les produits Roxtec Ex

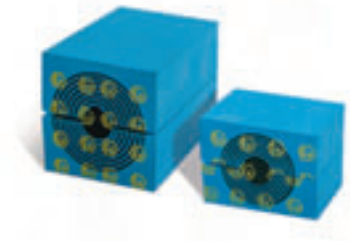

## La Directive ATEX

La Directive 94/9/EC est communément assimilée à la directive produits ATEX (Atmosphères explosibles). Son enjeu est d'éliminer ou minimiser les risques résultant de l'emploi de certains produits dans ou en relation avec une atmosphère potentiellement explosible.

La directive produits ATEX est une directive d'harmonisation totale, c'est-à-dire que ses réglementations

remplacent les législations nationales et européennes divergentes qui couvrent les mêmes sujets que ceux stipulés dans la directive produits ATEX.

La directive ATEX produits s'applique dans les pays de l'Union Européenne ainsi qu'au Lichtenstein, l'Islande et la Norvège.

### Normes

Les produits Ex de Roxtec sont testés, approuvés et certifiés conformément aux normes suivantes :

EN 60079-0:2006  
 EN 60079-7:2003  
 EN 61241-0:2006  
 EN 61241-1:2004  
 IEC 60079-0:2004  
 IEC 60079-7:2001  
 IEC 61241-0:2006  
 IEC 61241-1:2004

## IECEx, schéma de certification international

Le schéma de certification IECEx simplifie le commerce mondial et la maintenance des équipements prévus pour une utilisation en atmosphères explosibles. Le schéma IECEx s'applique sur un mode volontaire. Il est géré par l'IEC, organisme de normalisa-

tion, et se fonde sur l'acceptation mondiale de rapports d'essais des Etats membres.

La certification repose sur des critères de normes internationales spécifiques de l'IEC relatives aux équipements anti-déflagrants.

# Réduction des risques avec Roxtec

Le but des produits Roxtec Ex est de minimiser les risques qu'une explosion se produise

## Qu'est ce qu'une atmosphère explosible ?

Une atmosphère explosible se définit comme un mélange avec l'air, dans les conditions atmosphériques, de substances inflammables sous forme de gaz, vapeurs, brouillards, poussières ou fibres, dans lequel, après inflammation, la combus-

tion se propage à l'ensemble du mélange non brûlé. L'inflammation peut être provoquée par différentes sources (surfaces brûlantes, étincelles électriques, flammes nues, étincelles produites par frottement mécanique ...)

## Qu'est-ce qu'une explosion ?

Une explosion est la réaction chimique brusque d'un matériau inflammable et de l'oxygène. Pour qu'une explosion puisse se produire, 3 conditions doivent être remplies :

- 1: Matériau inflammable
- 2: Oxygène
- 3: Source d'inflammation

*Feu, étincelles, surfaces à température élevée*

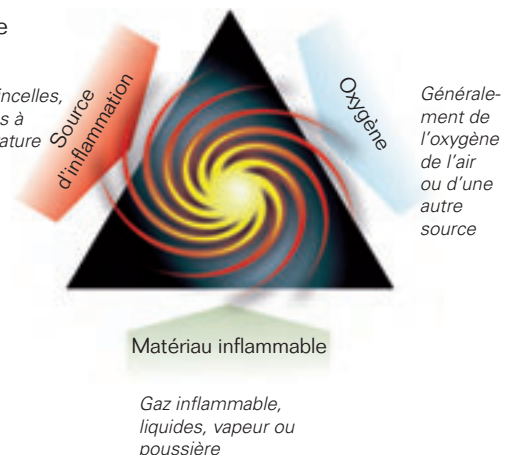

## Réduction des risques en général

Dans toutes les situations où il peut y avoir une atmosphère explosible, les étapes suivantes devraient être prises pour minimiser les risques d'une explosion :

- Elimination de l'atmosphère explosible autour de la source d'inflammation
- Elimination de la source d'inflammation
- Substituer à une substance inflammable
- Diminuer la température ambiante

Cependant, en pratique, il est très difficile de s'assurer qu'une atmosphère explosible n'apparaîtra pas.

Dans ces cas, la directive produits ATEX apporte les mesures de protection nécessaires.

# Le marquage Roxtec Ex

Tous les produits Roxtec Ex sont clairement identifiés en accord avec la directive ATEX. Les produits Roxtec Ex sont facilement identifiés par des étiquettes jaunes Ex et des symboles Ex.

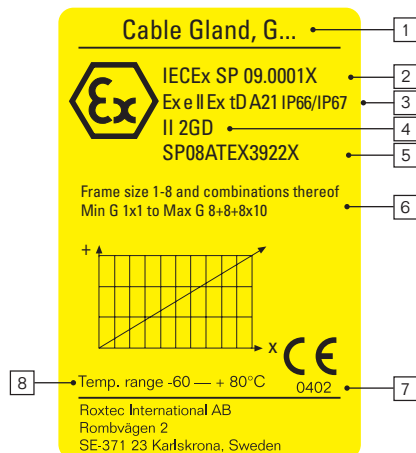

1. Type de traversée de câbles.
2. Numéro de certificat de l'IEC Ex.  
**U** = Marquage servant à indiquer que l'équipement est un composant Ex.  
**X** = Marquage servant à indiquer que des conditions particulières pour une utilisation sûre s'appliquent pour la certification du produit.
3. **Ex e II** = Marquage pour la protection contre les gaz explosibles potentiels.  
**Ex** = Symbole pour indiquer que l'appareil électrique correspond à une ou plusieurs techniques de protection contre l'explosion.  
**e** = symbole pour chaque type de technique de protection utilisée. « e » indique une sécurité augmentée.  
**II** = le groupe des appareils électriques  
**Ex tD** = Marquage pour la protection contre les poussières explosibles potentielles. Protégé par armoire.  
**A21** = L'équipement est conçu pour être placé dans les zones 21 et 22 (pas dans la zone 20).  
**IP66/IP67** = classement IP indice de protection
4. **II** = Le groupe d'équipement des appareils électriques.  
**2 GD** = L'équipement (ou composant Ex) répond aux critères de catégorie 2 pour les atmosphères à gaz explosibles (G) et à poussières explosibles (D) conformément à la directive ATEX.
5. **SP** = Nom ou symbole de l'organisme habilité  
**08** = Année de certification  
**3922, 3919** = N° consécutif.  
**U** = Marquage servant à indiquer que l'équipement est un composant Ex.  
**X** = Marquage servant à indiquer que des conditions spéciales pour une utilisation sécurisée s'appliquent pour la certification du produit.
6. Désignation type pour la bague certifiée.
7. **0402** = numéro de série de l'organisme habilité
8. Température ambiante mini/max.
9. Pour les bagues certifiées comme équipement conformément à la directive ATEX, la marque CE est également apposée.

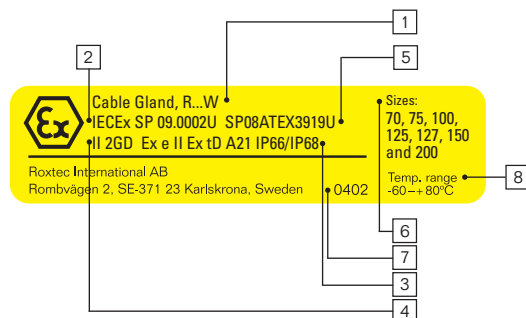

# Definitions

Definizioni » Definitionen » Definiciones » Définitions

**GB**

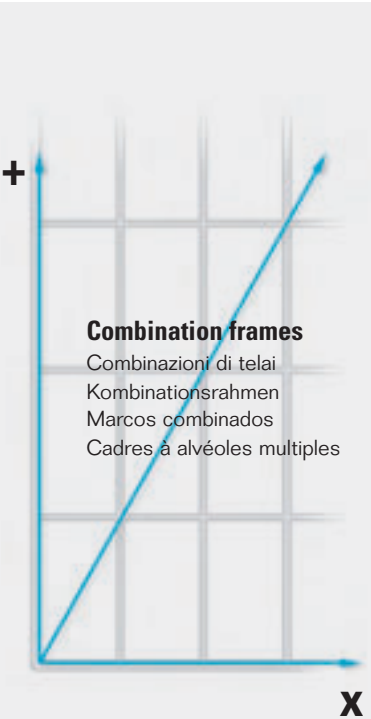

## Combination frames

Combinazioni di telai  
Kombinationsrahmen  
Marcos combinados  
Cadres à alvéoles multiples

Example S 6 frames  
Esempio telai S 6  
Beispiel S 6 Rahmen  
Ejemplo Marcos S 6  
Exemple avec cadres S-6

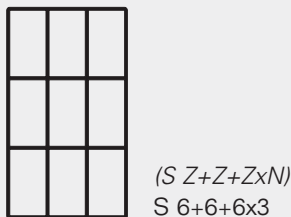
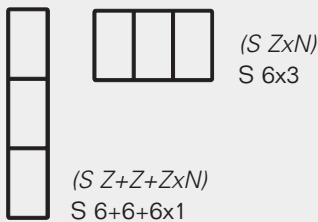

Explained here are specific definitions and acronyms valid to Roxtec products and solutions.

### Technical references

For technical references i.e., for standards and specifications in technical text we refer to the English version

### Aperture dimensions

For aperture dimensions, please see the installation instruction

### Internal frame dimensions

Total area inside the frame opening:  
*Packing space* + Compression unit

### Packing space

Area per opening to be filled with modules

### Roxtec Modules, RM Ex

Depth is always 60 mm, 2.362" if nothing else is stated

### Roxtec Modules, CM Ex

Depth is always 30 mm, 1.181" if nothing else is stated

### Dimensions and weight

All values and dimensions in sketches and charts are theoretical.

**H**  
External height

**W**  
External width

**D**  
Depth

**Z**  
Frame size

**N**  
Number of openings in horizontal direction

### Ratings

#### IP

Ingress protection acc. to IEC 60529  
For more information, please see Roxtec Technical Appendix on [www.roxtec.com](http://www.roxtec.com)

#### ATEX

ATEX 94/9/EC Directive  
Atmosphères Explosibles

#### IECEX

International standard for equipment for use in explosive atmospheres.  
IEC = International Electrotechnical Commission.  
For rules and details of the IECEX scheme visit [www.iecex.com](http://www.iecex.com)

Since certifications are constantly updated, please contact your local Roxtec supplier or e-mail: [info@roxtec.com](mailto:info@roxtec.com) for information about valid approvals from different classification societies, or other authorities.

## IT

In questa sezione sono riportate le definizioni specifiche e gli acronimi relativi ai prodotti e alle soluzioni Roxtec.

### Referenze tecniche

Per le referenze, gli standard e le specifiche tecniche nel testo ci riferiamo alla versione inglese

### Dimensioni interne dei telai

Si intende l'area all'interno del telaio  
*Spazio per i moduli* + spazio per l'unità di compressione

### Dimensioni delle aperture

Per le dimensioni delle aperture, vedere le istruzioni di montaggio

### Spazio di riempimento

Area da riempire con i moduli

### Telai regular

La profondità è sempre 60 mm 2.362", salvo diversa indicazione

### Telai compact

La profondità è sempre 30 mm 1.181", salvo diversa indicazione

### Dimensioni e pesi

Tutti i valori e le dimensioni sui grafici sono teoriche

### H

Altezza esterna

### W

Larghezza esterna

### D

Profondità

### Z

Grandezza telaio

### N

Numero di aperture in orizzontale

## Protezioni

### IP

Ingresso protezione secondo IEC 60529

Per ulteriori informazioni, vedere l'Appendice tecnica Roxtec sul sito [www.roxtec.com](http://www.roxtec.com)

### ATEX

ATEX 94/9/EC Directive

Atmosphere Explosibles

### IECEx

Standard internazionale per le apparecchiature destinate ad essere utilizzate in atmosfere esplosive.

IEC = Commissione Elettrotecnica Internazionale.

Per le norme e i dettagli del programma della IECEx visitare il sito [www.iecex.com](http://www.iecex.com)

Dato che i certificati sono costantemente aggiornati, Vi preghiamo di voler contattare il Vostro rappresentante locale Roxtec o tramite e-mail: [info@roxtec.com](mailto:info@roxtec.com) per informazioni riguardo la validità delle classificazioni o tipologie dei certificati.

**DE**

Hier werden die im Zusammenhang mit Roxtec-Produkten und -lösungen verwendeten Begriffe und Abkürzungen erklärt.

**Technische Referenzen**

Bei der Angabe technischer Referenzen, wie z.B. Normen und Spezifikationen in technischen Texten, beziehen wir uns auf die englische Version

**Innere Rahmenabmessungen**

Gesamtbereich des Inneren der Rahmenöffnung  
*Belegraum* + Kompressionseinheit

**Öffnungsabmessungen**

Öffnungsabmessungen siehe Installationsanleitung

**Belegraum**

Öffnungsbereich der mit Modulen bestückt wird

**Standardrahmen**

Die Tiefe beträgt immer 60 mm, 2.362", sofern nichts anderes angegeben ist

**Kompaktrahmen**

Die Tiefe beträgt immer 30 mm, 1.181", sofern nichts anderes angegeben ist

**Abmessungen und Gewicht**

Alle angegebenen Werte und Maße in Skizzen und Tabellen sind rechnerische Werte

**H**

Äußere Höhe

**W**

Äußere Breite

**D**

Tiefe

**Z**

Rahmengröße

**N**

Anzahl der horizontalen Öffnungen

**Anforderungen****IP**

IP-Schutzarten gemäß IEC 60529  
Weitere Informationen siehe Roxtec Technical Appendix unter [www.roxtec.com](http://www.roxtec.com)

**ATEX**

ATEX 94/9/EC Directive  
Atmosphères Explosibles

**IECEX**

Internationales Zertifizierungsschema für Geräte, die in explosiven Atmosphären verwendet werden.  
IEC = International Electrotechnical Commission.  
Regeln und Details des IECEX Schemas siehe [www.iecex.com](http://www.iecex.com)

Da die Zertifikate ständig erneuert werden, kontaktieren Sie bitte Ihre Roxtec Vertretung oder senden Sie eine e-mail an: [info@roxtec.com](mailto:info@roxtec.com), um sich über gültige Zulassungen verschiedener Klassifikationsgesellschaften oder anderer Behörden zu informieren.

**ES**

A continuación se explican acrónimos y definiciones específicas válidas para los productos y soluciones de Roxtec.

**Referencias técnicas**

Para referencias técnicas, como por ejemplo los estándares y las especificaciones en textos técnicos, nos basaremos en la versión inglesa

**Dimensiones interiores de los marcos**

Espacio total dentro del hueco del marco  
*Espacio útil de sellado* + unidad de compresión

**Dimensiones del agujero**

Para las dimensiones del agujero, consulte las instrucciones de instalación

**Espacio útil de sellado**

Espacio por hueco para ser rellenado con módulos

**Marcos estándar**

El fondo es siempre de 60mm, 2.362" a no ser que se especifique lo contrario

**Marcos compactos**

El fondo es siempre de 30mm, 1.181" a no ser que se especifique lo contrario

**Dimensiones y peso**

Todos los valores y las dimensiones de los cuadros y gráficos son teóricas

**H**

Altura externa

**W**

Anchura externa

**D**

Profundidad

**Z**

Tamaño del marco

**N**

Número de huecos en dirección horizontal



**FR**

## Clasificaciones

### IP

Protección de entrada según IEC 60529  
Para más información, consulte el Apéndice Técnico de Roxtec en [www.roxtec.com](http://www.roxtec.com)

### ATEX

Directiva de atmósferas explosivas ATEX 94/9/EC

### IECEX

Estándar internacional para uso de equipos en atmósferas explosivas.  
IEC = Comisión electrotécnica internacional.  
Para más información sobre las normas y detalles del programa de certificación IECEX, visite [www.iecex.com](http://www.iecex.com)

Dado que las certificaciones están actualizándose constantemente, por favor, contacte con su distribuidor de Roxtec local o envíe un e-mail a: [info@roxtec.com](mailto:info@roxtec.com) para obtener más información sobre los certificados vigentes de los diferentes organismos de clasificación u otras autoridades.

Vous trouverez ici l'explication de définitions et acronymes spécifiques valides pour les produits et solutions Roxtec.

### Références techniques

Pour toutes les références techniques, c'est-à-dire pour les standards et les spécifications en langage technique, nous nous référons à la version de texte en Anglais

### Dimensions intérieures du cadre

Espace total à l'intérieur de l'alvéole  
*Espace de remplissage* + unité de compression

### Dimensions de l'ouverture

Pour les dimensions de l'ouverture, veuillez vous reporter aux instructions de montage.

### Espace de remplissage

Espace de l'alvéole à remplir de modules

### Cadres de la gamme standard

La profondeur est toujours égale à 60mm, 2.362" si rien d'autre n'est indiqué

### Cadres compacts

La profondeur est toujours égale à 30mm, 1.181" si rien d'autre n'est indiqué

### Dimensions et poids

Toutes les valeurs et les dimensions sur les croquis et graphiques sont théoriques

### H

Hauteur hors-tout

### W

Largeur hors-tout

### D

Profondeur

### Z

Taille du cadre

### N

Nombre d'alvéoles horizontales

## Régimes

### IP

Classement IP selon CEI 60529  
Pour plus d'informations, reportez-vous à l'annexe technique de Roxtec sur le site [www.roxtec.com](http://www.roxtec.com)

### ATEX

Directive ATEX 94/9/CE  
Atmosphères explosibles

### IECEX

Norme internationale pour les équipements à utiliser en atmosphères explosibles.  
IEC = International Electrotechnical Commission (Commission électrotechnique internationale).  
Pour obtenir les règles et détails du schéma de l'IECEX, consultez le site [www.iecex.com](http://www.iecex.com)

En raison de mises à jour régulières des certificats, veuillez contacter votre distributeur local Roxtec ou par courriel: [info@roxtec.com](mailto:info@roxtec.com) pour obtenir les procès verbaux en cours de validité des différentes sociétés de classification.

# Roxtec RM Ex modules



**GB** Sealing modules for use with Roxtec Ex frames. The modules include Multidiameter™, the Roxtec technology based on removable layers, for perfect adaptation to different sizes of cables. When used with a solid core, the module functions as a spare module for future capacity.

- For use with Group RM components
- Adaptable sealing modules for cables 3.0-99.0 mm (0.118"-3.898") OD

**ES** Módulos de sellado para usar con marcos Roxtec. El Multidiameter™, la tecnología de Roxtec basada en capas desmontables que permiten una perfecta adaptación al cable. Si se usa con un núcleo central sólido, el módulo sirve de módulo de reserva para el futuro.

- Para uso con componentes del grupo RM
- Módulos adaptables para cables con diámetros exteriores de 3,0-99,0mm (0.118"-3.898")

**IT** Moduli di sigillatura da usare con i telai Roxtec. Multidiameter™, la tecnologia Roxtec basata su strati rimovibili, per adattarsi perfettamente al cavo. Quando viene utilizzata con il nucleo centrale, il modulo funziona da ricambio per future installazioni.

- Da usare con i componenti del Gruppo RM.
- Adattabilità del modulo di sigillatura per cavi da 3.0-99.0 mm (0.118"-3.898") OD

**FR** Modules d'étanchéité pour les cadres Roxtec, adaptables à un câble grâce à la technologie Multidiameter™ basée sur des couches à peler. Utilisé avec un noyau central, le module fonctionne comme un module de réserve pour une capacité ultérieure.

- Pour composants du groupe RM
- Modules d'étanchéité adaptables pour les câbles d'un diamètre externe compris entre 3 et 99 mm (0.118"-3.898")

**DE** Dichtungsmodule für Roxtec Rahmen. Die Roxtec Multidiameter™, Technologie basiert auf entfernbaren Pellen zur perfekten Anpassung an ein Kabel. Bei Verwendung mit einem festen Kern dient das Modul als Reservemodul für zusätzliche Kabel.

- Zur Verwendung mit Komponenten der Gruppe RM
- Anpassbare Dichtungsmodule für Kabel mit AD 3-99 mm (0.118"-3.898")

## RM Ex modules with core

Moduli Ex con nucleo » Module Ex mit Kern » Módulos Ex con núcleo central » Modules Ex, avec noyau central

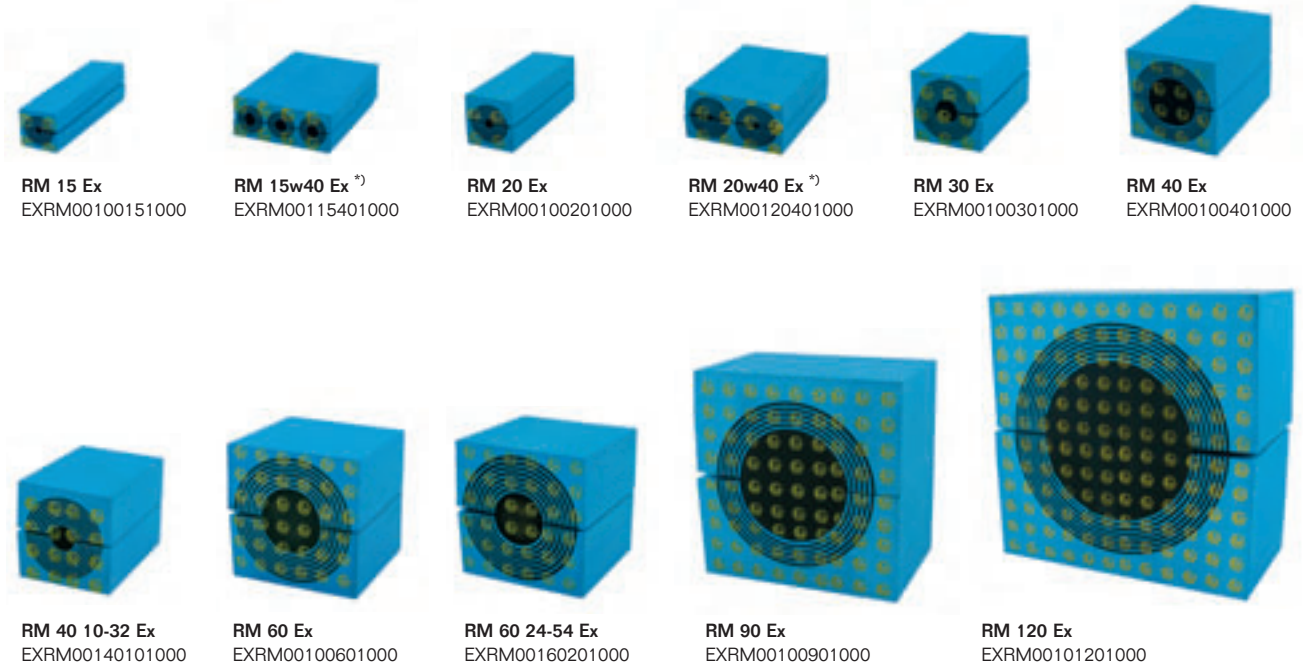

<b>IT</b>	Modulo	Numero di cavo/tubo	Per diametro di cavo/tubo Ø <sub>a</sub> -Ø <sub>b</sub> (mm)   Ø <sub>a</sub> -Ø <sub>b</sub> (in)		Dim. esterne (mm) HxW (D=60 mm)	Peso ved. pag. 37	Art. Nr.
<b>DE</b>	Modul	Anzahl der Kabel/Rohre	Für Kabel-/Rohrdurchmesser Ø <sub>a</sub> -Ø <sub>b</sub> (mm)   Ø <sub>a</sub> -Ø <sub>b</sub> (in.)		Außenmaße (mm) HxW (D=60 mm)	Gewicht Siehe Seite 37	Art.-Nr.
<b>ES</b>	Módulo	Número de cables/tuberías	Para diámetro de cable/ tubería Ø <sub>a</sub> -Ø <sub>b</sub> (mm)   Ø <sub>a</sub> -Ø <sub>b</sub> (pulgadas)		Dim. externas (mm) HxW (D=60 mm)	Peso véase la página 37	Nº art.
<b>FR</b>	Module	Nombre de câbles/tuyauteries	Pour diamètre de câble/tuyauterie Ø <sub>a</sub> -Ø <sub>b</sub> (mm)   Ø <sub>a</sub> -Ø <sub>b</sub> (pouces)		Dim. Extérieures (mm) HxW (D=60 mm)	Poids voir page 37	Nº d'article
<b>GB</b>	Module	Number of cables/pipes	For cable/pipe diameter Ø <sub>a</sub> -Ø <sub>b</sub> (mm)   Ø <sub>a</sub> -Ø <sub>b</sub> (in)		External dim. (mm) HxW (D=60 mm)	Weight see page 37	Art. No.
	<b>RM 15 Ex</b>	1	0+ 3.0-11.0	0+ 0.118-0.433	15x15		<b>EXRM00100151000</b>
	<b>RM 15w40 Ex <sup>*)</sup></b>	3	0+ 3.5-10.5	0+ 0.138-0.413	15x40		<b>EXRM00115401000</b>
	<b>RM 20 Ex</b>	1	0+ 4.0-14.5	0+ 0.157-0.571	20x20		<b>EXRM00100201000</b>
	<b>RM 20w40 Ex <sup>*)</sup></b>	2	0+ 3.5-16.5	0+ 0.138-0.650	20x40		<b>EXRM00120401000</b>
	<b>RM 30 Ex</b>	1	0+ 10.0-25.0	0+ 0.394-0.984	30x30		<b>EXRM00100301000</b>
	<b>RM 40 Ex</b>	1	0+ 21.5-34.5	0+ 0.846-1.358	40x40		<b>EXRM00100401000</b>
	<b>RM 40 10-32 Ex</b>	1	0+ 9.5-32.5	0+ 0.374-1.280	40x40		<b>EXRM00140101000</b>
	<b>RM 60 Ex</b>	1	0+ 28.0-54.0	0+ 1.102-2.126	60x60		<b>EXRM00100601000</b>
	<b>RM 60 24-54 Ex</b>	1	0+ 24.0-54.0	0+ 0.945-2.126	60x60		<b>EXRM01060245400</b>
	<b>RM 90 Ex</b>	1	0+ 48.0-71.0	0+ 1.890-2.795	90x90		<b>EXRM00100901000</b>
	<b>RM 120 Ex</b>	1	0+ 67.5-99.0	0+ 2.657-3.898	120x120		<b>EXRM00101201000</b>

<sup>\*)</sup> See page 37 / ved. pag. 37 / Siehe Seite 37 / Véase la página 37 / Voir page 37

# RM Ex modules without core

Moduli Ex senza nucleo » Module Ex ohne Kern » Módulos Ex sin núcleo central » Modules Ex, sans noyau central

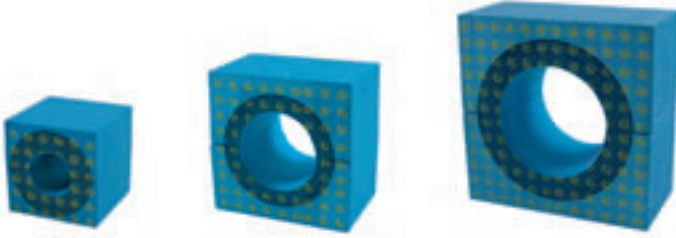

**RM 60 Ex woc**  
EXRM00000601000

**RM 90 Ex woc**  
EXRM00000901000

**RM 120 Ex woc**  
EXRM00001201000

	Modulo	Numero di cavo/tubo	Per diametro di cavo/tubo $\varnothing_a$ - $\varnothing_b$ (mm)   $\varnothing_a$ - $\varnothing_b$ (in)	Dim. esterne (mm) HxW (D=60 mm)	Peso ved. pag. 37	Art. Nr.
<b>IT</b>	Modulo	Numero di cavo/tubo	Per diametro di cavo/tubo $\varnothing_a$ - $\varnothing_b$ (mm)   $\varnothing_a$ - $\varnothing_b$ (in)	Dim. esterne (mm) HxW (D=60 mm)	Peso ved. pag. 37	Art. Nr.
<b>DE</b>	Modul	Anzahl der Kabel/Rohre	Für Kabel-/Rohrdurchmesser $\varnothing_a$ - $\varnothing_b$ (mm)   $\varnothing_a$ - $\varnothing_b$ (in.)	Außenmaße (mm) HxW (D=60 mm)	Gewicht Siehe Seite 37	Art.-Nr.
<b>ES</b>	Módulo	Número de cables/tuberías	Para diámetro de cable/ tubería $\varnothing_a$ - $\varnothing_b$ (mm)   $\varnothing_a$ - $\varnothing_b$ (pulgadas)	Dim. externas (mm) HxW (D=60 mm)	Peso véase la página 37	Nº art.
<b>FR</b>	Module	Nombre de câbles/tuyauteries	Pour diamètre de câble/tuyauterie $\varnothing_a$ - $\varnothing_b$ (mm)   $\varnothing_a$ - $\varnothing_b$ (pouces)	Dim. Extérieures (mm) HxW (D=60 mm)	Poids voir page 37	N° d'article
<b>GB</b>	Module	Number of cables/pipes	For cable/pipe diameter $\varnothing_a$ - $\varnothing_b$ (mm)   $\varnothing_a$ - $\varnothing_b$ (in)	External dim. (mm) HxW (D=60 mm)	Weight see page 37	Art. No.
	<b>RM 60 Ex woc</b>	1	28.0-54.0   1.102-2.126	60x60		<b>EXRM00000601000</b>
	<b>RM 90 Ex woc</b>	1	48.0-71.0   1.890-2.795	90x90		<b>EXRM00000901000</b>
	<b>RM 120 Ex woc</b>	1	67.5-99.0   2.657-3.898	120x120		<b>EXRM00001201000</b>

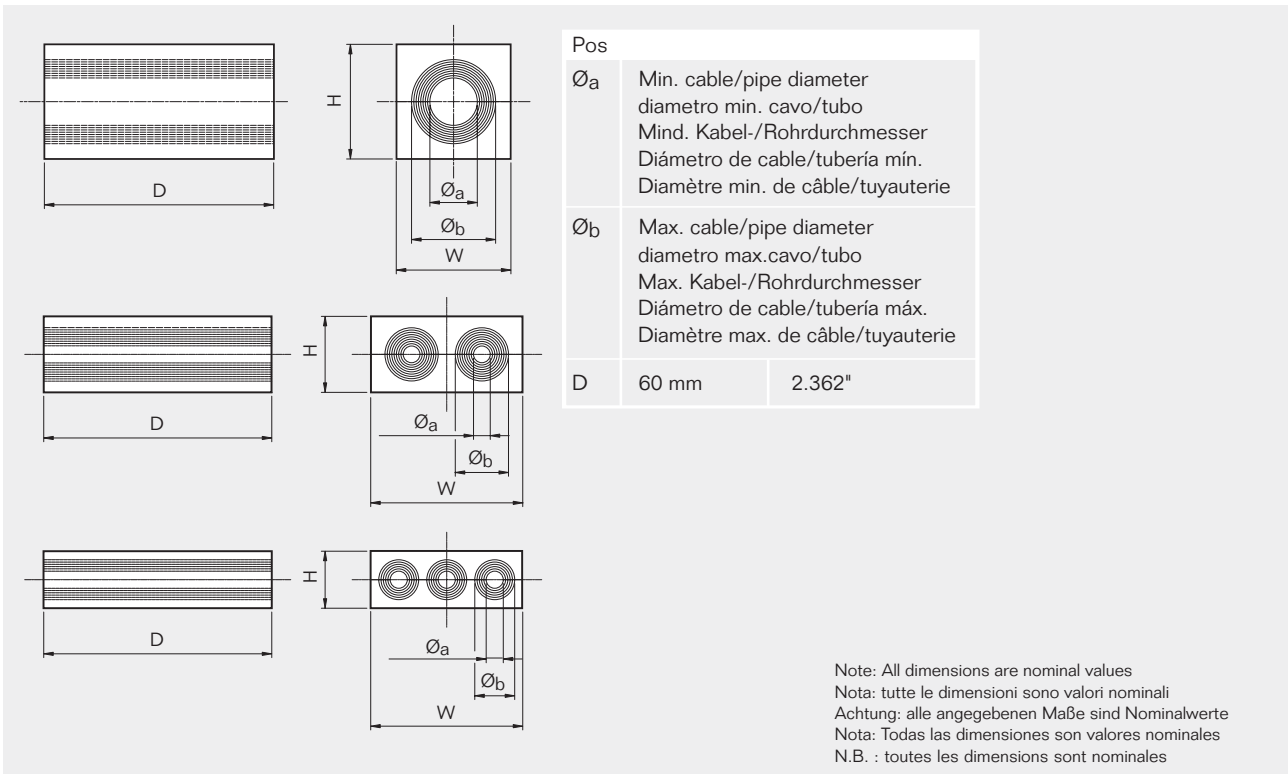

# RM Ex modules, weight

Peso dei moduli Ex » Gewicht der Module Ex » Peso de los módulos Ex » Poids modules Ex

<b>IT</b>	Modulo	(kg)	Peso min. - max.	(lb)	Art. Nr.
<b>DE</b>	Modul	(kg)	Gewicht Min. - Max.	(lb)	Art.-Nr.
<b>ES</b>	Módulo	(kg)	Peso Mín - Máx	(libra)	Nº art.
<b>FR</b>	Module	(kg)	Poids Min - Max	(lb)	Nº d'article
<b>GB</b>	Module	(kg)	Weight Min - Max	(lb)	Art. No.
	<b>RM 15 Ex</b>	0.01 - 0.02		0.022 - 0.044	<b>EXRM00100151000</b>
	<b>RM 15w40 Ex *)</b>	0.04 - 0.05		0.088 - 0.110	<b>EXRM00115401000</b>
	<b>RM 20 Ex</b>	0.02 - 0.04		0.044 - 0.088	<b>EXRM00100201000</b>
	<b>RM 20w40 Ex *)</b>	0.04 - 0.07		0.088 - 0.154	<b>EXRM00120401000</b>
	<b>RM 30 Ex</b>	0.04 - 0.08		0.088 - 0.176	<b>EXRM00100301000</b>
	<b>RM 40 Ex</b>	0.07 - 0.14		0.154 - 0.309	<b>EXRM00100401000</b>
	<b>RM 40 10-32 Ex</b>	0.07 - 0.14		0.154 - 0.309	<b>EXRM00140101000</b>
	<b>RM 60 Ex</b>	0.13 - 0.33		0.287 - 0.728	<b>EXRM00100601000</b>
	<b>RM 60 24-54 Ex</b>	0.13 - 0.33		0.287 - 0.728	<b>EXRM01060245400</b>
	<b>RM 90 Ex</b>	0.39 - 0.72		0.860 - 1.587	<b>EXRM00100901000</b>
	<b>RM 120 Ex</b>	0.62 - 1.25		1.367 - 2.756	<b>EXRM00101201000</b>
	<b>RM 60 Ex woc</b>	0.13 - 0.26		0.287 - 0.573	<b>EXRM00000601000</b>
	<b>RM 90 Ex woc</b>	0.39 - 0.56		0.860 - 1.253	<b>EXRM00000901000</b>
	<b>RM 120 Ex woc</b>	0.62 - 0.94		1.367 - 2.072	<b>EXRM00001201000</b>

\*) Smart tip: Whenever possible we recommend choosing twin or triplet modules like RM 20w40 Ex or RM15w40 Ex. Benefits are an even higher area efficiency per frame opening, quicker installation and increased cost effectiveness.

\*) Consejo práctico: Recomendamos elegir módulos dobles o triples, como el RM20w40 Ex o el RM15w40 Ex, siempre que sea posible. Sus ventajas son una eficacia en el área incluso mayor, una instalación más rápida y mayor optimización de costes.

\*) NB: ogni volta che è possibile, vi raccomandiamo di scegliere moduli doppi o tripli come RM 20w40 Ex o RM 15w40 Ex. Il vantaggio è una migliore densità di passaggio dei cavi, un'installazione più rapida e un'ottimizzazione dei costi.

\*) Astuce : à chaque fois que cela est possible, nous recommandons d'utiliser les modules doubles ou triples RM20w40 Ex ou RM15w40 Ex. Les avantages sont une meilleure densité de passages de câbles ou de tuyauteries, une installation plus rapide et un gain économique.

\*) Tipp: nach Möglichkeit empfehlen wir Zweier- oder Dreier-Module wie RM 20w40 Ex oder RM 15w40 Ex. Die Vorzüge sind eine noch effizientere Nutzung pro Rahmenöffnung, schnellere Installation und eine höhere Kosteneffizienz.

# Solid compensation modules Ex

Moduli di compensazione Ex » Füllstücke und Ausgleichsscheiben Ex » Módulos sólidos de compensación Ex » Modules pleins et modules de compensation Ex

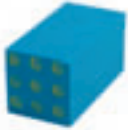

**RM 30/0 Ex**  
EXRM00300301000



**RM 5/0x24 Ex**  
EXRM00305241000

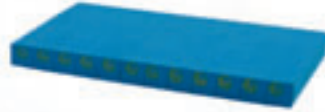

**RM 10/0x12 Ex**  
EXRM00310121000

IT	Modulo	Dim. esterne (mm) HxW (D=60 mm)	(kg)	Peso (lb)	Art. Nr.
DE	Modul	Außenmaße (mm) HxW (D=60 mm)	(kg)	Gewicht (lb)	Art.-Nr.
ES	Módulo	Dim. externas (mm) HxW (D=60 mm)	(kg)	Peso (libra)	Nº art.
FR	Module	Dim. Extérieure (mm) HxW (D=60 mm)	(kg)	Poids (lb)	Nº d'article
GB	Module	External dim. (mm) HxW (D=60)	(kg)	Weight (lb)	Art No.
	<b>RM 5/0x24 Ex</b>	5x120	0.06	0.126	<b>EXRM00305241000</b>
	<b>RM 10/0x12 Ex</b>	10x120	0.12	0.256	<b>EXRM00310121000</b>
	<b>RM 15/0 Ex</b>	15x15	0.02	0.049	<b>EXRM00300151000</b>
	<b>RM 20/0 Ex</b>	20x20	0.04	0.086	<b>EXRM00300201000</b>
	<b>RM 30/0 Ex</b>	30x30	0.08	0.179	<b>EXRM00300301000</b>
	<b>RM 40/0 Ex</b>	40x40	0.15	0.320	<b>EXRM00300401000</b>
	<b>RM 60/0 Ex</b>	60x60	0.33	0.719	<b>EXRM00300601000</b>
	<b>RM 30H90/0 Ex*</b>	90x30	0.24	0.537	<b>EXRM00130901000</b>

\*To be used side by side RM 90 Ex in rectangular frames

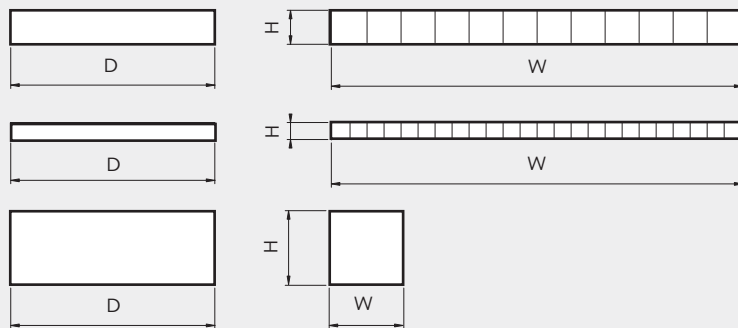

Pos	(mm)	(in)
D	60	2.362

Note: All dimensions are nominal values  
 Nota: tutte le dimensioni sono valori nominali  
 Achtung: alle angegebenen Maße sind Nominalwerte  
 Nota: Todas las dimensiones son valores nominales  
 N.B.: toutes les dimensions sont nominales

Smart tip: Consider using an RM module rather than a solid module. A Roxtec RM module installed with a solid centre core, serves the same purpose as a traditional solid module, plus it provides spare capacity for future installations.

NB: utilizzate ove possibile un modulo RM invece di un modulo solido. Un modulo RM installato con un nucleo centrale solido svolge la stessa funzione di un modulo solido, lasciando però spazio libero per installazioni future.

Tipp: Das Roxtec Modul verfügt über einen festen Kern, der erst beim Durchführen von Kabeln oder Rohren entfernt wird. Bis dahin dient das Modul mit Kern als Reservestück und erspart die Verwendung zusätzlicher Füllstücke.

Sugerencia: Considere usar un módulo RM en lugar de uno sólido. Un módulo RM de Roxtec instalado con un núcleo central sólido cumple la misma función que uno tradicional, además de proporcionar capacidad de reserva para futuras instalaciones.

Le module Roxtec est muni d'un noyau central. Si le noyau n'est pas enlevé du module pour faire passer un câble ou une tuyauterie, celui-ci peut servir de module de réserve, rendant inutile l'utilisation de modules pleins comme ci-dessus.

# Roxtec CM Ex modules

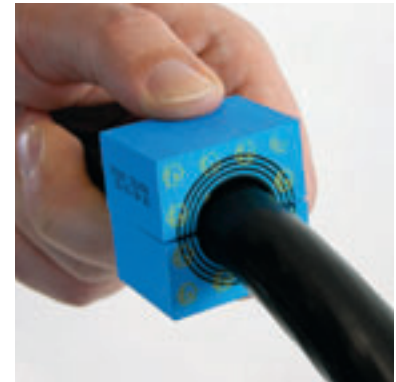
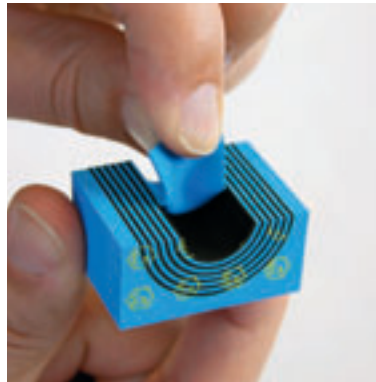
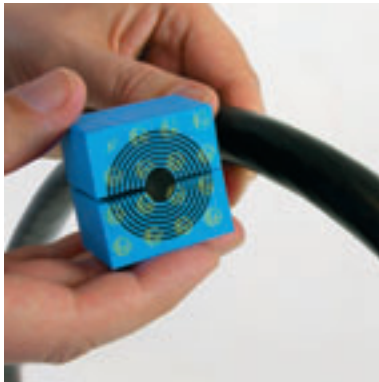

**GB** Sealing modules for use with Roxtec Ex frames. The modules include Multidiameter™, the Roxtec technology based on removable layers, for perfect adaptation to different sizes of cables. When used with a solid core, the module functions as a spare module for future capacity.

- For use with Group CM components
- Adaptable sealing modules for cables 3.5-32.5mm (0.138"-1.280") OD

**ES** Módulos de sellado para usar con marcos Roxtec. El Multidiameter™, la tecnología de Roxtec basada en capas desmontables que permiten una perfecta adaptación al cable. Si se usa con un núcleo central sólido, el módulo sirve de módulo de reserva para el futuro.

- Para uso con componentes del grupo CM
- Módulos adaptables para cables con diámetros exteriores de 3,5-32,5mm (0.138"-1.280")

**IT** Moduli di sigillatura da usare con i telai Roxtec. Multidiameter™, la tecnologia Roxtec basata su strati rimovibili, per adattarsi perfettamente al cavo. Quando viene utilizzata con il nucleo centrale, il modulo funziona da ricambio per future installazioni.

- Da usare con i componenti del Gruppo CM.
- Adattabilità del modulo di sigillatura per cavi da 3.5-32.5 mm (0.138"-1.280") OD

**FR** Modules d'étanchéité pour les cadres Roxtec, adaptables à un câble grâce à la technologie Multidiameter™ basée sur des couches à peler. Utilisé avec un noyau central, le module fonctionne comme un module de réserve pour une capacité ultérieure.

- Pour composants du groupe CM
- Modules d'étanchéité adaptables pour les câbles d'un diamètre externe compris entre 3,5 et 32,5 mm (0.138"-1.280")

**DE** Dichtungsmodule für Roxtec Rahmen. Die Roxtec Multidiameter™, Technologie basiert auf entfernbaren Pellen zur perfekten Anpassung an ein Kabel. Bei Verwendung mit einem festen Kern dient das Modul als Reservemodul für zukünftige Anwendungen.

- Zur Verwendung mit Komponenten der Gruppe CM
- Anpassbare Dichtungsmodule für Kabel mit AD 3,5-32,5 mm (0.138"-1.280")

# CM Ex modules with core

Moduli CM con nucleo » CM Module Ex mit Kern » Módulos CM Ex con núcleo central »  
 Modules CM Ex, avec noyau central

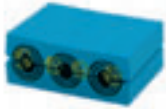

**CM 15w40 Ex** \*)  
EXC000115401000



**CM 20w40 Ex** \*)  
EXC000120401000

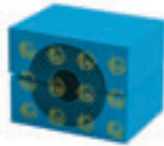

**CM 30w40 Ex**  
EXC000130401000

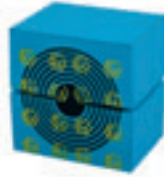

**CM 40 10-32 Ex**  
EXC000140101000

<b>IT</b>	Moduli	Numero di cavi/tubi	Per diametro cavi/tubi Ø <sub>a</sub> -Ø <sub>b</sub> (mm)   Ø <sub>a</sub> -Ø <sub>b</sub> (in)		Dimensioni esterne (HxW) (D=30 mm)	Peso Ved. Pag. 41	Art Nr.
<b>DE</b>	Modul	Anzahl der Kabel/Rohre	Für Kabel-/Rohrdurchmesser Ø <sub>a</sub> -Ø <sub>b</sub> (mm)   Ø <sub>a</sub> -Ø <sub>b</sub> (in.)		Außenmaße (mm) HxW (D=30 mm)	Gewicht Siehe Seite 41	Art.-Nr.
<b>ES</b>	Módulo	Número de cables/tuberías	Para diámetro de cable/ tubería Ø <sub>a</sub> -Ø <sub>b</sub> (mm)   Ø <sub>a</sub> -Ø <sub>b</sub> (pulgadas)		Diám. externo (mm) (HxW) (D=30 mm)	Peso véase la página 41	Nº art.
<b>FR</b>	Module	Nombre de câbles/ tuyauteries	Pour diamètre de câble/tuyauterie Ø <sub>a</sub> -Ø <sub>b</sub> (mm)   Ø <sub>a</sub> -Ø <sub>b</sub> (pouces)		Dim. Extérieures (mm) HxW (D=30 mm)	Poids voir page 41	Nº d'article
<b>GB</b>	Module	Number of cables/pipes	For cable/pipe diameter Ø <sub>a</sub> -Ø <sub>b</sub> (mm)   Ø <sub>a</sub> -Ø <sub>b</sub> (in)		External dim. (mm) (HxW) (D=30 mm)	Weight se page 41	Art No.
	<b>CM 15w40 Ex</b> *)	3	0+ 3.5-10.5	0+ 0.138-0.413	15x40		<b>EXC000115401000</b>
	<b>CM 20w40 Ex</b> *)	2	0+ 3.5-16.5	0+ 0.138-0.650	20x40		<b>EXC000120401000</b>
	<b>CM 30w40 Ex</b>	1	0+ 10.0-25.0	0+ 0.394-0.984	30x40		<b>EXC000130401000</b>
	<b>CM 40 10-32 Ex</b>	1	0+ 9.5-32.5	0+ 0.374-1.280	40x40		<b>EXC000140101000</b>

\*) Smart tip: Whenever possible we recommend choosing twin or triplet modules like CM 15w40 Ex or CM 20w40 Ex. Benefits are an even higher area efficiency per frame opening, quicker installation and increased cost effectiveness.

\*) Consejo práctico: Recomendamos elegir módulos dobles o triples, como el CM 20w40 Ex o el CM 15w40 Ex, siempre que sea posible. Sus ventajas son una eficacia en el área incluso mayor, una instalación más rápida y mayor optimización de costes.

\*) NB: ogni volta che è possibile, vi raccomandiamo di scegliere moduli doppi o tripli come CM 20w40 Ex o CM 15w40 Ex. Il vantaggio è una migliore densità di passaggio dei cavi, un'installazione più rapida e un'ottimizzazione dei costi.

\*) Astuce : à chaque fois que cela est possible, nous recommandons d'utiliser les modules doubles ou triples CM 15w40 Ex ou CM 20w40 Ex. Les avantages sont une meilleure densité de passages de câbles ou de tuyauteries, une installation plus rapide et un gain économique.

\*) Tipp: nach Möglichkeit empfehlen wir Zweier- oder Dreier-Module wie CM 15w40 Ex oder CM 20w40 Ex. Die Vorzüge sind eine noch effizientere Nutzung pro Rahmenöffnung, schnellere Installation und eine höhere Kosteneffizienz.



# CM Ex modules weight

Peso dei moduli CM Ex » Gewicht der CM Module Ex »  
 Peso de los módulos CM Ex » Poids des modules CM Ex

IT	Modulo	(kg)	Peso min. - max.	(lb)	Art. nr.
DE	Modul	(kg)	Gewicht Min. - Max.	(lb)	Art.-Nr.
ES	Módulo	(kg)	Peso Min - Máx	(libra)	Nº art.
FR	Module	(kg)	Poids Min - Max	(lb)	Nº d'article
GB	Module	(kg)	Weight Min - Max	(lb)	Art. No.
	<b>CM 15w40 Ex</b>	0.02 - 0.03		0.044 - 0.055	<b>EXC000115401000</b>
	<b>CM 20w40 Ex</b>	0.02 - 0.04		0.044 - 0.077	<b>EXC000120401000</b>
	<b>CM 30w40 Ex</b>	0.04 - 0.06		0.077 - 0.121	<b>EXC000130401000</b>
	<b>CM 40 10-32 Ex</b>	0.04 - 0.07		0.077 - 0.135	<b>EXC000140101000</b>

Pos	
Ø <sub>a</sub>	Min. cable diameter Diametro min. cavo Mind. Kabeldurchmesser Diámetro de cable mín. Diamètre min. de câble
Ø <sub>b</sub>	Max. cable diameter Diametro max. cavo Max. Kabeldurchmesser Diámetro de cable máx. Diamètre max. de câble
D	30 mm      1.181"

Note: All dimensions are nominal values  
 Nota: tutte le dimensioni sono valori nominali  
 Achtung: alle angegebenen Maße sind Nominalwerte  
 Nota: Todas las dimensiones son valores nominales  
 N.B. : toutes les dimensions sont nominales

# CM Solid compensation modules Ex

Moduli di compensazione CM Ex ▶ CM Ausgleichsscheiben Ex ▶ Módulos sólidos de compensación CM Ex ▶ CM Modules pleins et modules de compensation Ex



**CM 5w40/0 Ex**  
EXC000305401000



**CM 10w40/0 Ex**  
EXC000110401000

IT	Modulo	Diam. esterno (mm) HxW (D=30)	(kg)	Peso (lb)	Art. Nr.
DE	Modul	Außenmaße (mm) HxW (D=30 mm)	(kg)	Gewicht (lb)	Art.-Nr.
ES	Módulo	Dim. externas (mm) HxW (D=30 mm)	(kg)	Peso (libra)	Nº art.
FR	Module	Dim.Extérieures (mm) HxW (D=30 mm)	(kg)	Poids (lb)	Nº d'article
GB	Module	External dim. (mm) HxW (D=30)	kg)	Weight (lb)	Art No.
	<b>CM 5w40/0 Ex</b>	5x40	0.01	0.022	<b>EXC000305401000</b>
	<b>CM 10w40/0 Ex</b>	10x40	0.02	0.044	<b>EXC000110401000</b>

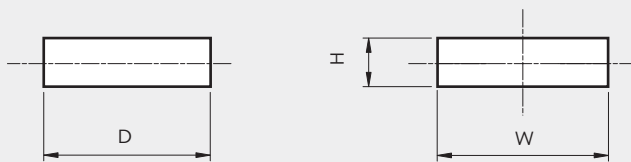

Pos	(mm)	(in)
D	30	1.181

Note: All dimensions are nominal values  
 Nota: tutte le dimensioni sono valori nominali  
 Achtung: alle angegebenen Maße sind Nominalwerte  
 Nota: Todas las dimensiones son valores nominales  
 N.B. : toutes les dimensions sont nominales

Smart tip: Consider using an RM module rather than a solid module. A Roxtec RM module installed with a solid centre core, serves the same purpose as a traditional solid module, plus it provides spare capacity for future installations.

NB: utilizzate ove possibile un modulo RM invece di un modulo solido. Un modulo RM installato con un nucleo centrale solido svolge la stessa funzione di un modulo solido, lasciando però spazio libero per installazioni future.

Tipp: Das Roxtec Modul verfügt über einen festen Kern, der erst beim Durchführen von Kabeln oder Rohren entfernt wird. Bis dahin dient das Modul mit Kern als Reservestück und erspart die Verwendung zusätzlicher Füllstücke.

Sugerencia: Considere usar un módulo RM en lugar de uno sólido. Un módulo RM de Roxtec instalado con un núcleo central sólido cumple la misma función que uno tradicional, además de proporcionar capacidad de reserva para futuras instalaciones.

Le module Roxtec est muni d'un noyau central. Si le noyau n'est pas enlevé du module pour faire passer un câble ou une tuyauterie, celui-ci peut servir de module de réserve, rendant inutile l'utilisation de modules pleins comme ci-dessus.

# S Ex frame



**GB** Roxtec S Ex frame is a metal frame available as a single opening, or in combinations with several openings in width and / or height.

- For use with Group RM components
- Attachment by welding

**IT** Il telaio S di Roxtec è un telaio metallico da fissare prevalentemente con saldatura. Disponibile ad apertura singola o come combinazione di aperture variabili in profondità e/o altezza.

- Fissaggio con saldatura
- Da utilizzare con componenti del gruppo RM

**DE** Der Roxtec S-Rahmen ist ein Metallrahmen. Erhältlich als Einzelrahmen mit nur einer Öffnung oder als Rahmenkombination in horizontaler und/oder vertikaler Anordnung.

- Zur Verwendung mit Komponenten der Gruppe RM
- Schweißmontage

**ES** El marco S Ex de Roxtec es un marco metálico de adhesión principalmente mediante soldadura. Disponible con una única abertura o en combinaciones con varias aberturas en anchura y/ o altura.

- Uso con componentes del grupo RM
- Adhesión por soldadura

**FR** Le cadre S Roxtec est un cadre métallique disponible avec ouvertures uniques ou en association avec différentes largeurs et/ou hauteurs d'ouverture.

- Pour composants du Groupe RM
- Fixation par soudage

## Ex S Ex frames, primed, mild steel

Telaio S Ex, in acciaio con prima mano d'antiruggine } S Ex Rahmen, Baustahl geprimert }  
 Marcos S Ex en acero dulce imprimado } Cadres S Ex, acier doux peint



**S 6x1 Ex Primed**  
 EXS006000000112

Parts needed for a complete solution



page 34



page 76

For information about other frame combinations,  
 please contact your local Roxtec supplier or  
 e-mail: [info@roxtec.com](mailto:info@roxtec.com)

**Cert. No:** IECEx SP 09.0002U, SP08ATEX3923U, **ATEX:** II 2GD Ex e II Ex tD A21, **IP Class:** 66/67, **Temp:** -60 — +80°C

IT	Telaio	Apertura telaio	Spazio di riempimento (mm)	Dimensioni esterne (D=60 mm)		Peso		Art.Nr.
				HxW (mm)	HxW (tum)	(kg)	(lb)	
DE	Rahmen	Rahmenöffnungen	Belegraum (mm)	Außenmaße (D=60 mm)		Gewicht		Art.-Nr.
				HxW (mm)	HxW (in.)	(kg)	(lb)	
ES	Marco	Aberturas del marco	Espacio útil de sellado (mm)	Dim. externas (D=60 mm)		Peso		Nº art.
				HxW (mm)	HxW (pulgadas)	(kg)	(libra)	
FR	Cadre	Nombre d'alvéoles	Espace de remplissage (mm)	Dim. Extérieures (D=60 mm)		Poids		Nº d'article
				HxW (mm)	HxW (pouces)	(kg)	(lb)	
GB	Frame	Frame openings	Packing space (mm)	External dimensions (D=60 mm)		Weight		Art. No.
				HxW (mm)	HxW (in)	(kg)	(lb)	
	<b>S 2x1Ex primed</b>	1	60 x 120	121 x 141	4.764 x 5.551	2.2	4.938	<b>EXS002000000112</b>
	<b>S 4x1 Ex primed</b>	1	120 x 120	180 x 141	7.087 x 5.551	2.8	6.151	<b>EXS004000000112</b>
	<b>S 4x2 Ex primed</b>	2	120 x 120	180 x 271	7.087 x 10.669	4.7	10.318	<b>EXS004000000212</b>
	<b>S 4x3 Ex primed</b>	3	120 x 120	180 x 402	7.087 x 15.827	6.6	14.484	<b>EXS004000000312</b>
	<b>S 4x4 Ex primed</b>	4	120 x 120	180 x 532	7.087 x 20.945	8.5	18.629	<b>EXS004000000412</b>
	<b>S 4x5 Ex primed</b>	5	120 x 120	180 x 663	7.087 x 26.102	10.3	22.796	<b>EXS004000000512</b>
	<b>S 4+4x1 Ex primed</b>	2	120x120	349x141	13.740x5.551	5.0	11.067	<b>EXS004400000112</b>
	<b>S 4+4x2 Ex primed</b>	4	120x120	359x271	14.134x10.669	9.5	20.878	<b>EXS004400000212</b>
	<b>S 4+4x3 Ex primed</b>	6	120x120	359x402	14.134x15.827	13.5	29.321	<b>EXS004400000312</b>
	<b>S 4+4x4 Ex primed</b>	8	120x120	359x532	14.134x20.945	17.1	37.743	<b>EXS004400000412</b>
	<b>S 4+4+4x1 Ex primed</b>	3	120x120	519x141	20.433x5.551	6.6	14.550	<b>EXS004440000112</b>
	<b>S 4+4+4x2 Ex primed</b>	6	120x120	539x271	21.220x10.669	14.2	31.305	<b>EXS004440000212</b>
	<b>S 4+4+4x3 Ex primed</b>	9	120x120	539x402	21.220x15.827	19.9	43.872	<b>EXS004440000312</b>
	<b>S 4+4+4x4 Ex primed</b>	12	120x120	539x532	21.220x20.945	26.2	57.761	<b>EXS004440000412</b>
	<b>S 6x1 Ex primed</b>	1	180 x 120	238 x 141	9.370 x 5.551	3.3	7.363	<b>EXS006000000112</b>
	<b>S 6x2 Ex primed</b>	2	180 x 120	238 x 271	9.370 x 10.669	5.5	12.147	<b>EXS006000000212</b>
	<b>S 6x3 Ex primed</b>	3	180 x 120	238 x 402	9.370 x 15.827	7.7	16.909	<b>EXS006000000312</b>

<b>IT</b>	Telaio	Aperture telaio	Spazio di riempimento (mm)	Dimensioni esterne (D=60 mm)		Peso		Art.Nr.
<b>DE</b>	Rahmen	Rahmenöffnungen	Belegraum (mm)	Außenmaße (D=60 mm)		Gewicht		Art.-Nr.
<b>ES</b>	Marco	Aberturas del marco	Espacio útil de sellado (mm)	Dim. externas (D=60 mm)		Peso		Nº art.
<b>FR</b>	Cadre	Nombre d'alvéoles	Espace de remplissage (mm)	Dim. Extérieures (D=60 mm)		Poids		Nº d'article
<b>GB</b>	Frame	Frame openings	Packing space (mm)	External dimensions (D=60 mm)		Weight		Art. No.
				HxW (mm)	HxW (in.)	(kg)	(lb)	
	<b>S 6x4 Ex primed</b>	4	180 x 120	238 x 532	9.370 x 20.945	9.8	21.671	<b>EXS006000000412</b>
	<b>S 6x5 Ex primed</b>	5	180 x 120	238 x 663	9.370 x 26.102	12.0	26.455	<b>EXS006000000512</b>
	<b>S 6+6x1 Ex primed</b>	2	180x120	466x141	18.346x5.551	6.1	13.492	<b>EXS006600000112</b>
	<b>S 6+6x2 Ex primed</b>	4	180x120	476x271	18.740x10.669	11.1	24.537	<b>EXS006600000212</b>
	<b>S 6+6x3 Ex primed</b>	6	180x120	476x402	18.740x15.827	15.5	34.171	<b>EXS006600000312</b>
	<b>S 6+6x4 Ex primed</b>	8	180x120	476x532	18.740x20.945	19.9	43.827	<b>EXS006600000412</b>
	<b>S 6+6+6x1 Ex primed</b>	3	180x120	694x141	27.323x5.551	8.2	18.078	<b>EXS006660000112</b>
	<b>S 8x1 Ex primed</b>	1	240 x 120	298 x 141	11.732 x 5.551	3.9	8.620	<b>EXS008000000112</b>
	<b>S 8x2 Ex primed</b>	2	240 x 120	298 x 271	11.732 x 10.669	6.1	13.382	<b>EXS008000000212</b>
	<b>S 8x3 Ex primed</b>	3	240 x 120	298 x 402	11.732 x 15.827	8.2	18.144	<b>EXS008000000312</b>
	<b>S 8x4 Ex primed</b>	4	240 x 120	298 x 532	11.732 x 20.945	10.4	22.928	<b>EXS008000000412</b>
	<b>S 8x5 Ex primed</b>	5	240 x 120	298 x 663	11.732 x 26.102	12.6	27.690	<b>EXS008000000512</b>
	<b>S 8+8x1 Ex primed</b>	2	240x120	586x141	23.071x5.551	7.3	16.005	<b>EXS008800000112</b>
	<b>S 8+8x2 Ex primed</b>	4	240x120	596x271	23.465x10.669	12.3	27.006	<b>EXS008800000212</b>
	<b>S 8+8x3 Ex primed</b>	6	240x120	596x402	23.465x15.827	16.6	36.640	<b>EXS008800000312</b>
	<b>S 8+8x4 Ex primed</b>	8	240x120	596x532	23.465x20.945	21.0	46.341	<b>EXS008800000412</b>
	<b>S 8+8+8x1 Ex primed</b>	3	240x120	874x141	34.409x5.551	9.9	21.826	<b>EXS008880000112</b>

## Ex frames, acid proof stainless steel

Telaio S Ex, in acciaio inox resistente agli acidi | S Ex Rahmen, säurefester, rostfreier Edelstahl | Marcos S Ex en acero inoxidable a prueba de ácidos | Cadre S Ex acier inox résistant aux acides.



S 6x1 Ex AISI 316  
EXS006000000121

Parts needed for a complete solution



page 34



page 76

For information about other frame combinations, please contact your local Roxtec supplier or e-mail: [info@roxtec.com](mailto:info@roxtec.com)

Cert. No: IECEx SP 09.0002U, SP08ATEX3923U, ATEX: II 2GD Ex e II Ex tD A21, IP Class: 66/67, Temp: -60 — +80°C

IT	Telaio	Apertura telaio	Spazio di riempimento (mm)	Dimensioni esterne (D=60 mm)		Peso		Art.Nr.
				HxW (mm)	HxW (tum)	(kg)	(lb)	
DE	Rahmen	Rahmenöffnungen	Belegraum (mm)	Außenmaße (D=60 mm)		Gewicht		Art.-Nr.
				HxW (mm)	HxW (in.)	(kg)	(lb)	
ES	Marco	Aberturas del marco	Espacio útil de sellado (mm)	Dim. externas (D=60 mm)		Peso		Nº art.
				HxW (mm)	HxW (pulgadas)	(kg)	(libra)	
FR	Cadre	Nombre d'alvéoles	Espace de remplissage (mm)	Dim. Extérieures (D=60 mm)		Poids		Nº d'article
				HxW (mm)	HxW (pouces)	(kg)	(lb)	
GB	Frame	Frame openings	Packing space (mm)	External dimensions (D=60 mm)		Weight		Art. No.
				HxW (mm)	HxW (in)	(kg)	(lb)	
	<b>S 2x1Ex AISI 316</b>	1	60 x 120	121 x 141	4.764 x 5.551	2.2	4.938	<b>EXS002000000121</b>
	<b>S 4x1 Ex AISI 316</b>	1	120 x 120	180 x 141	7.087 x 5.551	2.8	6.151	<b>EXS004000000121</b>
	<b>S 4x2 Ex AISI 316</b>	2	120 x 120	180 x 271	7.087 x 10.669	4.7	10.318	<b>EXS004000000221</b>
	<b>S 4x3 Ex AISI 316</b>	3	120 x 120	180 x 402	7.087 x 15.827	6.6	14.484	<b>EXS004000000321</b>
	<b>S 4x4 Ex AISI 316</b>	4	120 x 120	180 x 532	7.087 x 20.945	8.5	18.629	<b>EXS004000000421</b>
	<b>S 4x5 Ex AISI 316</b>	5	120 x 120	180 x 663	7.087 x 26.102	10.3	22.796	<b>EXS004000000521</b>
	<b>S 4+4x1 Ex AISI 316</b>	2	120x120	349x141	13.740x5.551	5.0	11.067	<b>EXS004400000121</b>
	<b>S 4+4+4x1 Ex AISI 316</b>	3	120x120	519x141	20.433x5.551	6.6	14.550	<b>EXS004440000121</b>
	<b>S 6x1 Ex AISI 316</b>	1	180 x 120	238 x 141	9.370 x 5.551	3.3	7.363	<b>EXS006000000121</b>
	<b>S 6x2 Ex AISI 316</b>	2	180 x 120	238 x 271	9.370 x 10.669	5.5	12.147	<b>EXS006000000221</b>
	<b>S 6x3 Ex AISI 316</b>	3	180 x 120	238 x 402	9.370 x 15.827	7.7	16.909	<b>EXS006000000321</b>
	<b>S 6x4 Ex AISI 316</b>	4	180 x 120	238 x 532	9.370 x 20.945	9.8	21.671	<b>EXS006000000421</b>
	<b>S 6x5 Ex AISI 316</b>	5	180 x 120	238 x 663	9.370 x 26.102	12.0	26.455	<b>EXS006000000521</b>
	<b>S 6+6x1 Ex AISI 316</b>	2	180x120	466x141	18.346x5.551	6.1	13.492	<b>EXS006600000121</b>
	<b>S 6+6x2 Ex AISI 316</b>	4	180x120	476x271	18.740x10.669	11.1	24.537	<b>EXS006600000221</b>
	<b>S 6+6x3 Ex AISI 316</b>	6	180x120	476x402	18.740x15.827	15.5	34.171	<b>EXS006600000321</b>
	<b>S 6+6x4 Ex AISI 316</b>	8	180x120	476x532	18.740x20.945	19.9	43.872	<b>EXS006600000421</b>

IT	Telaio	Apertura telaio	Spazio di riempimento (mm)	Dimensioni esterne (D=60 mm)		Peso		Art.Nr.
				HxW (mm)	HxW (tum)	(kg)	(lb)	
DE	Rahmen	Rahmenöffnungen	Belegraum (mm)	Außenmaße (D=60 mm)		Gewicht		Art.-Nr.
				HxW (mm)	HxW (in.)	(kg)	(lb)	
ES	Marco	Aberturas del marco	Espacio útil de sellado (mm)	Dim. externas (D=60 mm)		Peso		Nº art.
				HxW (mm)	HxW (pulgadas)	(kg)	(libra)	
FR	Cadre	Nombre d'alvéoles	Espace de remplissage (mm)	Dim. Extérieures (D=60 mm)		Poids		N° d'article
				HxW (mm)	HxW (pouces)	(kg)	(lb)	
GB	Frame	Frame openings	Packing space (mm)	External dimensions (D=60 mm)		Weight		Art. No.
				HxW (mm)	HxW (in)	(kg)	(lb)	
	<b>S 8x1 Ex AISI 316</b>	1	240 x 120	298 x 141	11.732 x 5.551	3.9	8.620	<b>EXS008000000121</b>
	<b>S 8x2 Ex AISI 316</b>	2	240 x 120	298 x 271	11.732 x 10.669	6.1	13.382	<b>EXS008000000221</b>
	<b>S 8x3 Ex AISI 316</b>	3	240 x 120	298 x 402	11.732 x 15.827	8.2	18.144	<b>EXS008000000321</b>
	<b>S 8x4 Ex AISI 316</b>	4	240 x 120	298 x 532	11.732 x 20.945	10.4	22.928	<b>EXS008000000421</b>
	<b>S 8x5 Ex AISI 316</b>	5	240 x 120	298 x 663	11.732 x 26.102	12.6	27.690	<b>EXS008000000521</b>
	<b>S 8+8x1 Ex AISI 316</b>	2	240x120	586x141	23.071x5.551	7.3	16.005	<b>EXS008800000121</b>
	<b>S 8+8+8x1 Ex AISI 316</b>	3	240x120	874x141	34.409x5.551	9.9	21.826	<b>EXS008880000121</b>



# S Ex frames, technical information

Telai S Ex, informazioni tecniche » S Ex Rahmen, technische Daten » Marcos S Ex, información técnica »  
Cadres S Ex, informations techniques

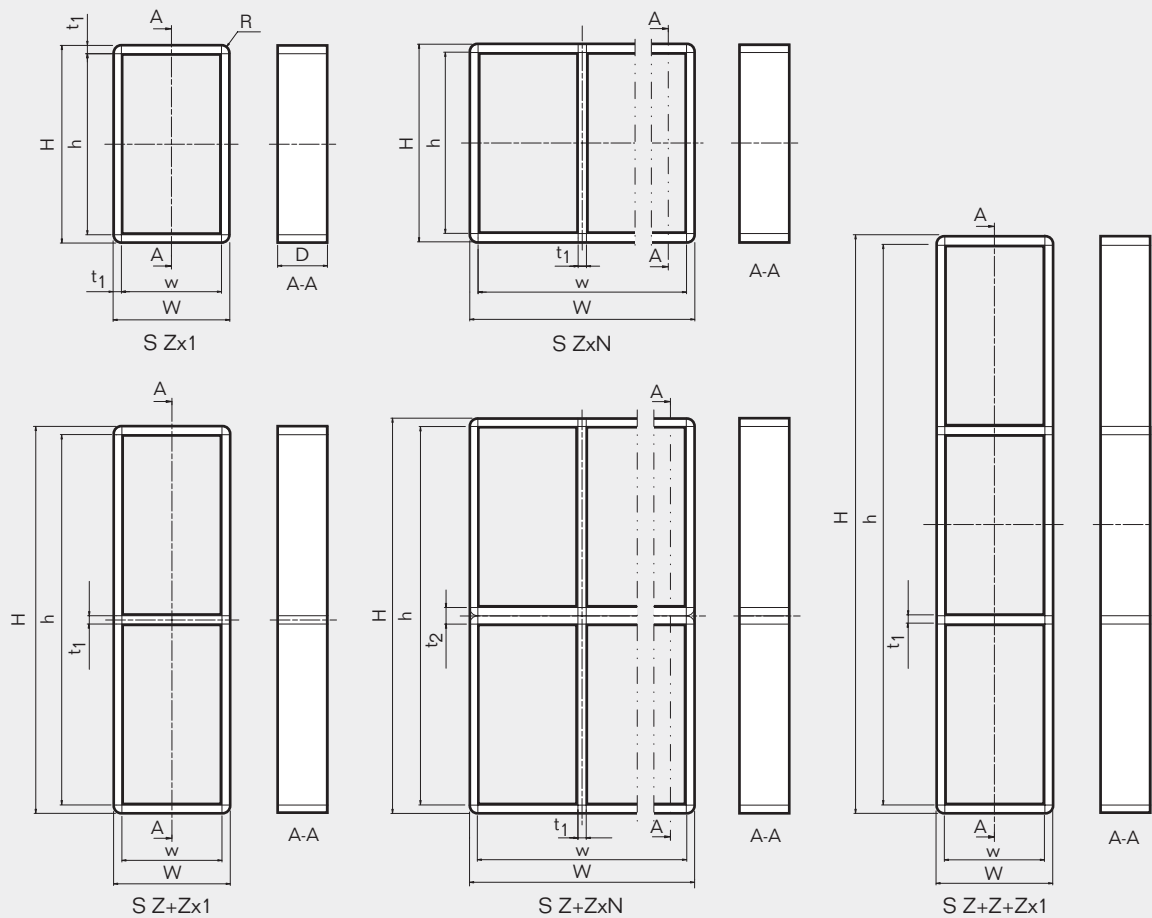

Pos	(mm)	(in)
h	H - 20	H - 0.787
w	W - 20	W - 0.787
D	60	2.362
t <sub>1</sub>	10	0.394
t <sub>2</sub>	20	0.787
R	R 10	R 0.394

Z = Frame size  
N = Number of horizontal openings

Z = Grandezza telaio  
N = Numero delle aperture orizzontali

Z = Rahmengröße  
N = Anzahl horizontaler Öffnungen

Z = Tamaño del marco  
N = Número de aberturas en sentido horizontal

Z = Taille du cadre  
N = Nombre d'alvéoles horizontales

Note: All dimensions are nominal values

Nota: tutte le dimensioni sono valori nominali

Achtung: Alle angegebenen Maße sind Nominalwerte

Nota: Todas las dimensiones son valores nominales

N.B.: toutes les dimensions sont nominales



# SF...W Ex frame



**GB** Roxtec SF...W Ex frame is a metal frame with flange. Available as a single opening, or in combinations with several openings in width and / or height.

- For use with Group RM components
- Attachment by welding

**ES** El marco SF...W Ex de Roxtec es un marco metálico con ala. Disponible con una única abertura o en combinaciones con varias aberturas en anchura y/ o altura.

- Uso con componentes del grupo RM
- Adhesión por soldadura

**IT** Il telaio SF...W Ex di Roxtec è un telaio metallico con flangia. Disponibile ad apertura singola o come combinazione di aperture variabili in profondità e/o altezza.

- Da utilizzare con componenti del gruppo RM
- Fissaggio con saldatura

**FR** Le cadre SF...W Ex Roxtec est un cadre métallique avec bride. Disponible avec ouvertures uniques ou en association avec différentes largeurs et/ou hauteurs d'ouverture.

- Pour composants du Groupe RM
- Fixation par soudage

**DE** Der Roxtec SF...W Ex Rahmen ist ein Metallrahmen mit Flansch. Erhältlich als Einzelrahmen mit nur einer Öffnung oder als Rahmenkombination in horizontaler und/oder vertikaler Anordnung.

- Zur Verwendung mit Komponenten der Gruppe RM
- Schweißmontage

## SF...W Ex frames, primed, mild steel

Telai SF...W Ex, in acciaio con prima mano d'antiruggine » SF...W Ex Rahmen, Baustahl geprimert »  
 Marcos SF...W Ex en acero dulce imprimado » Cadres SF...W Ex, acier doux peint



SF 6x1 W Ex primed  
 EXSFF6000000112

Parts needed for a complete solution



page 34



page 76

For information about other frame combinations,  
 please contact your local Roxtec supplier or  
 e-mail: [info@roxtec.com](mailto:info@roxtec.com)

Cert. No: IECEx SP 09.0002U, SP08ATEX3924U, ATEX: II 2GD Ex e II Ex tD A21, IP Class: 66/67, Temp: -60 — +80°C

IT	Telaio	Apertura telaio	Spazio di riempimento (mm)	Dimensioni esterne (D=65 mm)		Peso		Art.Nr.
				HxW (mm)	HxW (tum)	(kg)	(lb)	
DE	Rahmen	Rahmenöffnungen	Belegraum (mm)	Außenmaße (D=65 mm)		Gewicht		Art.-Nr.
				HxW (mm)	HxW (in.)	(kg)	(lb)	
ES	Marco	Aberturas del marco	Espacio útil de sellado (mm)	Dim. externas (D=65 mm)		Peso		Nº art.
				HxW (mm)	HxW (pulgadas)	(kg)	(libra)	
FR	Cadre	Nombre d'alvéoles	Espace de remplissage (mm)	Dim. Extérieures (D=65 mm)		Poids		Nº d'article
				HxW (mm)	HxW (pouces)	(kg)	(lb)	
GB	Frame	Frame openings	Packing space (mm)	External dimensions (D=60 mm)		Weight		Art. No.
				HxW (mm)	HxW (in)	(kg)	(lb)	
	<b>SF 2x1 W Ex primed</b>	1	60 x 120	241 x 261	9.488 x 10.276	6.0	13.184	<b>EXSF00200000112</b>
	<b>SF 4x1 W Ex primed</b>	1	120 x 120	300 x 261	11.811 x 10.276	7.1	15.675	<b>EXSF00400000112</b>
	<b>SF 4x2 W Ex primed</b>	2	120 x 120	300 x 391	11.811 x 15.394	10.4	22.862	<b>EXSF00400000212</b>
	<b>SF 4x3 W Ex primed</b>	3	120 x 120	300 x 522	11.811 x 20.551	13.6	30.049	<b>EXSF00400000312</b>
	<b>SF 4x4 W Ex primed</b>	4	120 x 120	300 x 652	11.811 x 25.669	16.9	37.236	<b>EXSF00400000412</b>
	<b>SF 4x5 W Ex primed</b>	5	120 x 120	300 x 783	11.811 x 30.827	20.2	44.423	<b>EXSF00400000512</b>
	<b>SF 4+4x1 W Ex primed</b>	2	120x120	469x261	18.465x10.276	10.9	24.118	<b>EXSF00440000112</b>
	<b>SF 4+4+4x1 W Ex primed</b>	3	120x120	639x261	25.157x10.276	14.8	32.540	<b>EXSF00444000112</b>
	<b>SF 6x1 W Ex primed</b>	1	180 x 120	358 x 261	14.095 x 10.276	8.2	18.144	<b>EXSF00600000112</b>
	<b>SF 6x2 W Ex primed</b>	2	180 x 120	358 x 391	14.095 x 15.394	11.8	25.948	<b>EXSF00600000212</b>
	<b>SF 6x3 W Ex primed</b>	3	180 x 120	358 x 522	14.095 x 20.551	15.3	33.752	<b>EXSF00600000312</b>
	<b>SF 6x4 W Ex primed</b>	4	180 x 120	358 x 652	14.095 x 25.669	18.8	41.557	<b>EXSF00600000412</b>
	<b>SF 6x5 W Ex primed</b>	5	180 x 120	358 x 783	14.095 x 30.827	22.4	49.339	<b>EXSF00600000512</b>
	<b>SF 6+6x1 W Ex primed</b>	2	180x120	586x261	23.071x10.276	13.1	28.968	<b>EXSF00660000112</b>
	<b>SF 6+6x2 W Ex primed</b>	4	180x120	596x391	23.465x15.394	19.6	43.320	<b>EXSF00660000212</b>
	<b>SF 6+6x3 W Ex primed</b>	6	180x120	596x522	23.465x20.551	25.4	56.107	<b>EXSF00660000312</b>
	<b>SF 6+6x4 W Ex primed</b>	8	180x120	596x652	23.465x25.669	31.2	68.872	<b>EXSF00660000412</b>

IT	Telaio	Apertura telaio	Spazio di riempimento (mm)	Dimensioni esterne (D=65 mm)		Peso		Art.Nr.
				HxW (mm)	HxW (tum)	(kg)	(lb)	
DE	Rahmen	Rahmenöffnungen	Belegraum (mm)	Außenmaße (D=65 mm)		Gewicht		Art.-Nr.
				HxW (mm)	HxW (in.)	(kg)	(lb)	
ES	Marco	Aberturas del marco	Espacio útil de sellado (mm)	Dim. externas (D=65 mm)		Peso		Nº art.
				HxW (mm)	HxW (pulgadas)	(kg)	(libra)	
FR	Cadre	Nombre d'alvéoles	Espace de remplissage (mm)	Dim. Extérieures (D=65 mm)		Poids		N° d'article
				HxW (mm)	HxW (pouces)	(kg)	(lb)	
GB	Frame	Frame openings	Packing space (mm)	External dimensions (D=60 mm)		Weight		Art. No.
				HxW (mm)	HxW (in)	(kg)	(lb)	
	<b>SF 6+6+6x1 W Ex primed</b>	3	180x120	814x261	32.047x10.276	18.1	39.991	<b>EXSF00666000112</b>
	<b>SF 8x1 W Ex primed</b>	1	240 x 120	418 x 261	16.457 x 10.276	9.4	20.701	<b>EXSF00800000112</b>
	<b>SF 8x2 W Ex primed</b>	2	240 x 120	418 x 391	16.457 x 15.394	13.2	29.123	<b>EXSF00800000212</b>
	<b>SF 8x3 W Ex primed</b>	3	240 x 120	418 x 522	16.457 x 20.551	17.0	37.544	<b>EXSF00800000312</b>
	<b>SF 8x4 W Ex primed</b>	4	240 x 120	418 x 652	16.457 x 25.669	20.8	45.966	<b>EXSF00800000412</b>
	<b>SF 8x5 W Ex primed</b>	5	240 x 120	418 x 783	16.457 x 30.827	24.7	54.387	<b>EXSF00800000512</b>
	<b>SF 8+8x1 W Ex primed</b>	2	240x120	706x261	27.795x10.276	15.5	34.171	<b>EXSF00880000112</b>
	<b>SF 8+8x2 W Ex primed</b>	4	240x120	716x391	28.189x15.394	22.6	49.758	<b>EXSF00880000212</b>
	<b>SF 8+8x3 W Ex primed</b>	6	240x120	716x522	28.189x20.551	28.9	63.779	<b>EXSF00880000312</b>
	<b>SF 8+8x4 W Ex primed</b>	8	240x120	716x652	28.189x25.669	35.3	77.800	<b>EXSF00880000412</b>



## SF...W Ex frames, acid proof stainless steel

Telaio SF...W Ex, in acciaio inox resistente agli acidi » SF...W Ex Rahmen, säurefester, rostfreier Edelstahl » Marcos SF...W Ex en acero inoxidable a prueba de ácidos » Cadres SF...W Ex, acier inox resistant aux acides



SF 6x1 W Ex AISI 316  
EXSFF6000000121

Parts needed for a complete solution



page 34



page 76

For information about other frame combinations, please contact your local Roxtec supplier or e-mail: [info@roxtec.com](mailto:info@roxtec.com)

Cert. No: IECEx SP 09.0002U, SP08ATEX3924U, ATEX: II 2GD Ex e II Ex tD A21, IP Class: 66/67, Temp: -60 — +80°C

IT	Telaio	Apertura telaio	Spazio di riempimento (mm)	Dimensioni esterne (D=65 mm)		Peso		Art.Nr.
				HxW (mm)	HxW (tum)	(kg)	(lb)	
DE	Rahmen	Rahmenöffnungen	Belegraum (mm)	Außenmaße (D=65 mm)		Gewicht		Art.-Nr.
				HxW (mm)	HxW (in.)	(kg)	(lb)	
ES	Marco	Aberturas del marco	Espacio útil de sellado (mm)	Dim. externas (D=65 mm)		Peso		Nº art.
				HxW (mm)	HxW (pulgadas)	(kg)	(libra)	
FR	Cadre	Nombre d'alvéoles	Espace de remplissage (mm)	Dim. Extérieures (D=65 mm)		Poids		Nº d'article
				HxW (mm)	HxW (pouces)	(kg)	(lb)	
GB	Frame	Frame openings	Packing space (mm)	External dimensions (D=60 mm)		Weight		Art. No.
				HxW (mm)	HxW (in)	(kg)	(lb)	
	<b>SF 2x1 W Ex AISI 316</b>	1	60 x 120	241 x 261	9.488 x 10.276	6.0	13.184	<b>EXSF00200000121</b>
	<b>SF 4x1 W Ex AISI 316</b>	1	120 x 120	300 x 261	11.811 x 10.276	7.1	15.675	<b>EXSF00400000121</b>
	<b>SF 4x2 W Ex AISI 316</b>	2	120 x 120	300 x 391	11.811 x 15.394	10.4	22.862	<b>EXSF00400000221</b>
	<b>SF 4x3 W Ex AISI 316</b>	3	120 x 120	300 x 522	11.811 x 20.551	13.6	30.049	<b>EXSF00400000321</b>
	<b>SF 4x4 W Ex AISI 316</b>	4	120 x 120	300 x 652	11.811 x 25.669	16.9	37.236	<b>EXSF00400000421</b>
	<b>SF 6x1 W Ex AISI 316</b>	1	180 x 120	358 x 261	14.095 x 10.276	8.2	18.144	<b>EXSF00600000121</b>
	<b>SF 6x2 W Ex AISI 316</b>	2	180 x 120	358 x 391	14.095 x 15.394	11.8	25.948	<b>EXSF00600000221</b>
	<b>SF 6x3 W Ex AISI 316</b>	3	180 x 120	358 x 522	14.095 x 20.551	15.3	33.752	<b>EXSF00600000321</b>
	<b>SF 6x4 W Ex AISI 316</b>	4	180 x 120	358 x 652	14.095 x 25.669	18.8	41.557	<b>EXSF00600000421</b>
	<b>SF 8x1 W Ex AISI 316</b>	1	240 x 120	418 x 261	16.457 x 10.276	9.4	20.701	<b>EXSF00800000121</b>
	<b>SF 8x2 W Ex AISI 316</b>	2	240 x 120	418 x 391	16.457 x 15.394	13.2	29.123	<b>EXSF00800000221</b>
	<b>SF 8x3 W Ex AISI 316</b>	3	240 x 120	418 x 522	16.457 x 20.551	17.0	37.544	<b>EXSF00800000321</b>
	<b>SF 8x4 W Ex AISI 316</b>	4	240 x 120	418 x 652	16.457 x 25.669	20.8	45.966	<b>EXSF00800000421</b>

# SF...W Ex frames, technical information

Telaio SF...W Ex, informazioni tecniche » SF...W Ex Rahmen, technische Daten »  
 Marcos SF...W Ex, información técnica » Cadres SF...W Ex , informations techniques

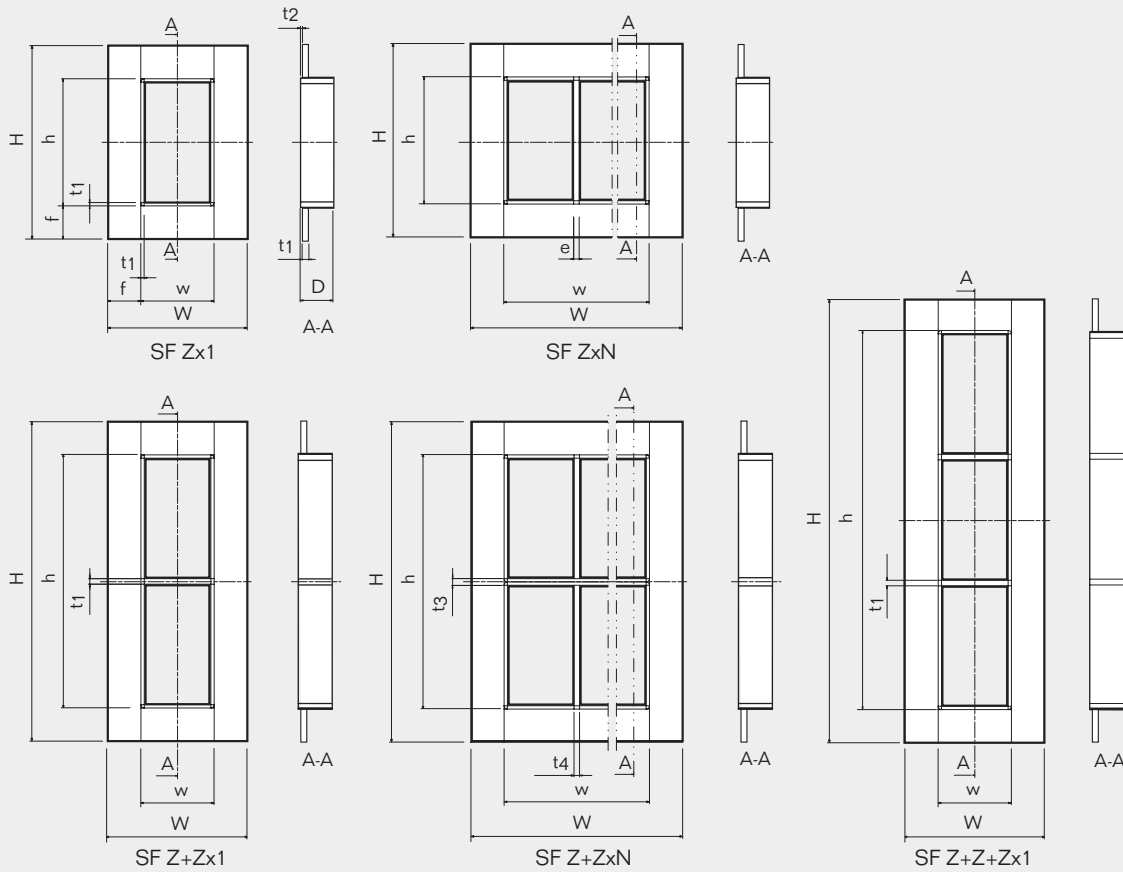

Pos	(mm)	(in)
h	H - 120	H - 4.724
w	W - 120	W - 4.724
D	60	2.362
f	60	2.362
t1	10	0.394
t2	3	0.118
t3	20	0.787

Z = Frame size  
 N = Number of horizontal openings

Z = Grandezza telaio  
 N = Numero delle aperture orizzontali

Z = Rahmengröße  
 N = Anzahl horizontaler Öffnungen

Z = Tamaño del marco  
 N = Número de aberturas en sentido horizontal

Z = Taille du cadre  
 N = Nombre d'alvéoles horizontales

Note: All dimensions are nominal values  
 Nota: tutte le dimensioni sono valori nominali  
 Achtung: Alle angegebenen Maße sind Nominalwerte  
 Nota: Todas las dimensiones son valores nominales  
 N.B. : toutes les dimensions sont nominales

# G Ex frame



**GB** The Roxtec G Ex is a flanged metal frame intended for bolting into place. The frame with its gasket is attached to the intended place by means of screws through pre-drilled holes (in the frame and the gasket).

**IT** Il telaio Roxtec G Ex è un telaio metallico flangiato per applicazioni ad imbullonare. Il telaio, dotato di una guarnizione di sigillatura, viene installato mediante viti o bulloni attraverso i fori esistenti (sia nella flangia che nella guarnizione).

**DE** Der Roxtec G Ex Rahmen ist ein Metallrahmen mit einem umlaufenden Flansch zum Aufschrauben. Der Rahmen verfügt über eine Gummidichtung und vorgebohrte Löcher (im Rahmen und in der Gummidichtung). Er wird einfach mit Hilfe von Schrauben befestigt.

**ES** El G Ex de Roxtec es un marco de metal para atornillar. El marco y su junta vienen con agujeros ya perforados y se fijan en su emplazamiento con tornillos.

**FR** Le cadre G Ex est un cadre métallique à bride pour des installations boulonnées. Le cadre et son joint sont fixés en place par le moyen de vis au travers des perçages (dans le cadre et le joint).

## G Ex frames, primed, mild steel

Telai G Ex , in acciaio con prima mano d'antiruggine » G Ex Rahmen, grundierter Baustahl »  
Marcos G Ex, en acero dulce imprimado » Cadre G Ex, acier doux peint



G 6x1 Ex primed  
EXG006000000112

Parts needed for a complete solution



page 34

page 76

For information about other frame combinations,  
please contact your local Roxtec supplier or  
e-mail: [info@roxtec.com](mailto:info@roxtec.com)

Cert. No: IECEx SP 09.0001X, SP08ATEX3922X, ATEX: II 2GD Ex e II Ex tD A21, IP Class: 66/67, Temp: -60 — +80°C

IT	Telaio	Apertura telaio	Spazio di riempimento (mm)	Dimensioni esterne (D=60 mm)		Peso		Art.Nr.
				HxW (mm)	HxW (in)	(kg)	(lb)	
DE	Rahmen	Rahmenöffnungen	Belegraum (mm)	Außenmaße (D=60 mm)		Gewicht		Art.-Nr.
				HxW (mm)	HxW (in.)	(kg)	(lb)	
ES	Marco	Aberturas del marco	Espacio útil de sellado (mm)	Dim. externas (D=60 mm)		Peso		Nº art.
				HxW (mm)	HxW (pulgadas)	(kg)	(libra)	
FR	Cadre	Nombre d'alvéoles	Espace de remplissage (mm)	Dim. Extérieures (D=60 mm)		Poids		Nº d'article
				HxW (mm)	HxW (pouces)	(kg)	(lb)	
GB	Frame	Frame openings	Packing space (mm)	External dimensions (D=60 mm)		Weight		Art. No.
				HxW (mm)	HxW (in)	(kg)	(lb)	
	<b>G 2x1 Ex primed</b>	1	60 x 120	221 x 241	8.701 x 9.488	3.4	6.834	<b>EXG002000000112</b>
	<b>G 4x1 Ex primed</b>	1	120 x 120	280 x 241	11.024 x 9.488	4.1	8.377	<b>EXG004000000112</b>
	<b>G 4x2 Ex primed</b>	2	120 x 120	292 x 383	11.496 x 15.079	6.3	13.977	<b>EXG004000000212</b>
	<b>G 4x3 Ex primed</b>	3	120 x 120	292 x 514	11.496 x 20.236	8.6	18.938	<b>EXG004000000312</b>
	<b>G 4x4 Ex primed</b>	4	120 x 120	292 x 644	11.496 x 25.354	10.8	23.898	<b>EXG004000000412</b>
	<b>G 4x5 Ex primed</b>	5	120 x 120	292 x 775	11.496 x 30.512	13.1	28.858	<b>EXG004000000512</b>
	<b>G 4+4x1 Ex primed</b>	2	120x120	461x253	8.150x9.961	6.9	15.212	<b>EXG004400000112</b>
	<b>G 4+4x2 Ex primed</b>	4	120x120	463x383	8.228x15.079	11.0	24.251	<b>EXG004400000212</b>
	<b>G 4+4x3 Ex primed</b>	6	120x120	463x514	8.228x20.236	15.0	33.069	<b>EXG004400000312</b>
	<b>G 4+4x4 Ex primed</b>	8	120x120	463x644	8.228x25.354	18.5	40.785	<b>EXG004400000412</b>
	<b>G 4+4+4x1 Ex primed</b>	3	120x120	631x253	24.843x9.961	9.8	21.605	<b>EXG004440000112</b>
	<b>G 6x1 Ex primed</b>	1	180 x 120	338 x 241	13.307 x 9.488	4.8	9.700	<b>EXG006000000112</b>
	<b>G 6x2 Ex primed</b>	2	180 x 120	350 x 383	13.780 x 15.079	7.3	16.072	<b>EXG006000000212</b>
	<b>G 6x3 Ex primed</b>	3	180 x 120	350 x 514	13.780 x 20.236	9.8	21.627	<b>EXG006000000312</b>
	<b>G 6x4 Ex primed</b>	4	180 x 120	350 x 644	13.780 x 25.354	12.3	27.205	<b>EXG006000000412</b>
	<b>G 6x5 Ex primed</b>	5	180 x 120	350 x 775	13.780 x 30.512	14.9	32.760	<b>EXG006000000512</b>

<b>IT</b>	Telaio	Apertura telaio	Spazio di riempimento (mm)	Dimensioni esterne (D=60 mm)		Peso		Art.Nr.
<b>DE</b>	Rahmen	Rahmenöffnungen	Belegraum (mm)	Außenmaße (D=60 mm)		Gewicht		Art.-Nr.
<b>ES</b>	Marco	Aberturas del marco	Espacio útil de sellado (mm)	Dim. externas (D=60 mm)		Peso		Nº art.
<b>FR</b>	Cadre	Nombre d'alvéoles	Espace de remplissage (mm)	Dim. Extérieures (D=60 mm)		Poids		N° d'article
<b>GB</b>	Frame	Frame openings	Packing space (mm)	External dimensions (D=60 mm)		Weight		Art. No.
				HxW (mm)	HxW (in)	(kg)	(lb)	
	<b>G 6+6x1 Ex primed</b>	2	180x120	578x253	22.756x9.961	8.7	19.180	<b>EXG006600000112</b>
	<b>G 6+6x2 Ex primed</b>	4	180x120	580x383	22.835x15.079	13.1	28.880	<b>EXG006600000212</b>
	<b>G 6+6x3 Ex primed</b>	6	180x120	580x514	22.835x20.236	17.3	38.140	<b>EXG006600000312</b>
	<b>G 6+6x4 Ex primed</b>	8	180x120	580x644	22.835x25.354	21.7	47.840	<b>EXG006600000412</b>
	<b>G 6+6x5 Ex primed</b>	10	180x120	580x775	22.835x30.512	26.2	57.761	<b>EXG006600000512</b>
	<b>G 6+6+6x1 Ex primed</b>	3	180x120	806x253	31.732x9.961	12.0	26.455	<b>EXG006660000112</b>
	<b>G 8x1 Ex primed</b>	1	240 x 120	398 x 241	15.669 x 9.488	5.5	11.243	<b>EXG008000000112</b>
	<b>G 8x2 Ex primed</b>	2	240 x 120	410 x 383	16.142 x 15.079	8.3	18.210	<b>EXG008000000212</b>
	<b>G 8x3 Ex primed</b>	3	240 x 120	410 x 514	16.142 x 20.236	11.1	24.405	<b>EXG008000000312</b>
	<b>G 8x4 Ex primed</b>	4	240 x 120	410 x 644	16.142 x 25.354	13.9	30.578	<b>EXG008000000412</b>



# G Ex frames, galvanized, mild steel

Telai G Ex, galvanizzato » G Ex Rahmen, feuerverzinkter Baustahl » Marcos G Ex en acero dulce galvanizado » Cadre G Ex, acier galvanisé, acier doux



G 6x1 Ex galv  
EXG006000000115

Parts needed for a complete solution



page 34

page 76

For information about other frame combinations, please contact your local Roxtec supplier or e-mail: [info@roxtec.com](mailto:info@roxtec.com)

Cert. No: IECEx SP 09.0001X, SP08ATEX3922X, ATEX: II 2GD Ex e II Ex tD A21, IP Class: 66/67, Temp: -60 — +80°C

IT	Telaio	Apertura telaio	Spazio di riempimento (mm)	Dimensioni esterne (D=60 mm)		Peso		Art.Nr.
	Rahmen	Rahmenöffnungen	Belegraum (mm)	HxW (mm)	HxW (in.)	(kg)	(lb)	
DE	Marco	Aberturas del marco	Espacio útil de sellado (mm)	Dim. externas (D=60 mm)		Peso		N° art.
ES	Cadre	Nombre d'alvéoles	Espace de remplissage (mm)	HxW (mm)	HxW (pouces)	(kg)	(libra)	
FR	Frame	Frame openings	Packing space (mm)	External dimensions (D=60 mm)		Weight		Art. No.
GB				HxW (mm)	HxW (in)	(kg)	(lb)	
	<b>G 2x1 Ex galv</b>	1	60 x 120	221 x 241	8.701 x 9.488	3.4	6.834	<b>EXG002000000115</b>
	<b>G 4x1 Ex galv</b>	1	120 x 120	280 x 241	11.024 x 9.488	4.1	8.377	<b>EXG004000000115</b>
	<b>G 4x2 Ex galv</b>	2	120 x 120	292 x 383	11.496 x 15.079	6.3	13.977	<b>EXG004000000215</b>
	<b>G 4x3 Ex galv</b>	3	120 x 120	292 x 514	11.496 x 20.236	8.6	18.938	<b>EXG004000000315</b>
	<b>G 4x4 Ex galv</b>	4	120 x 120	292 x 644	11.496 x 25.354	10.8	23.898	<b>EXG004000000415</b>
	<b>G 4x5 Ex galv</b>	5	120 x 120	292 x 775	11.496 x 30.512	13.1	28.858	<b>EXG004000000515</b>
	<b>G 4+4x1 Ex gal</b>	2	120x120	461x253	8.150x9.961	6.9	15.212	<b>EXG004400000115</b>
	<b>G 4+4+4x1 Ex galv</b>	3	120x120	631x253	24.843x9.961	9.8	21.605	<b>EXG004440000115</b>
	<b>G 6x1 Ex galv</b>	1	180 x 120	338 x 241	13.307 x 9.488	4.8	9.700	<b>EXG006000000115</b>
	<b>G 6x2 Ex galv</b>	2	180 x 120	350 x 383	13.780 x 15.079	7.3	16.072	<b>EXG006000000215</b>
	<b>G 6x3 Ex galv</b>	3	180 x 120	350 x 514	13.780 x 20.236	9.8	21.627	<b>EXG006000000315</b>
	<b>G 6x4 Ex galv</b>	4	180 x 120	350 x 644	13.780 x 25.354	12.3	27.205	<b>EXG006000000415</b>
	<b>G 6x5 Ex galv</b>	5	180 x 120	350 x 775	13.780 x 30.512	14.9	32.760	<b>EXG006000000515</b>
	<b>G 6+6x1 Ex galv</b>	2	180x120	578x253	22.756x9.961	8.7	19.180	<b>EXG006600000115</b>
	<b>G 6+6+6x1 Ex galv</b>	3	180x120	806x253	31.732x9.961	12.0	26.455	<b>EXG006660000115</b>
	<b>G 8x1 Ex galv</b>	1	240 x 120	398 x 241	15.669 x 9.488	5.5	11.243	<b>EXG008000000115</b>
	<b>G 8x2 Ex galv</b>	2	240 x 120	410 x 383	16.142 x 15.079	8.3	18.210	<b>EXG008000000215</b>
	<b>G 8x3 Ex galv</b>	3	240 x 120	410 x 514	16.142 x 20.236	11.1	24.405	<b>EXG008000000315</b>
	<b>G 8x4 Ex galv</b>	4	240 x 120	410 x 644	16.142 x 25.354	13.9	30.578	<b>EXG008000000415</b>

# G Ex frames, acid proof, stainless steel

Telai G Ex, in acciaio inox resistente agli acidi } G Ex Rahmen, säurefester, rostfreier Edelstahl }  
 Marcos G Ex en acero inoxidable a prueba de ácidos } Cadre G Ex, acier inox résistant aux acides



**G 6x1 Ex AISI 316**  
 EXG006000000121

Parts needed for a complete solution



page 34



page 76

For information about other frame combinations,  
 please contact your local Roxtec supplier or  
 e-mail: [info@roxtec.com](mailto:info@roxtec.com)

**Cert. No:** IECEx SP 09.0001X, SP08ATEX3922X, **ATEX:** II 2GD Ex e II Ex tD A21, **IP Class:** 66/67, **Temp:** -60 — +80°C

	Telaio	Aperture telaio	Spazio di riempimento (mm)	Dimensioni esterne (D=60 mm)		Peso		Art.Nr.
				HxW (mm)	HxW (in)	(kg)	(lb)	
<b>IT</b>	Telaio	Aperture telaio	Spazio di riempimento (mm)	Dimensioni esterne (D=60 mm)		Peso		Art.Nr.
<b>DE</b>	Rahmen	Rahmenöffnungen	Belegraum (mm)	Außenmaße (D=60 mm)		Gewicht		Art.-Nr.
<b>ES</b>	Marco	Aberturas del marco	Espacio útil de sellado (mm)	Dim. externas (D=60 mm)		Peso		Nº art.
<b>FR</b>	Cadre	Nombre d'alvéoles	Espace de remplissage (mm)	Dim. Extérieures (D=60 mm)		Poids		Nº d'article
<b>GB</b>	Frame	Frame openings	Packing space (mm)	External dimensions (D=60 mm)		Weight		Art. No.
	<b>G 2x1 Ex AISI 316</b>	1	60 x 120	233 x 253	9.173 x 9.961	3.4	7.562	<b>EXG002000000121</b>
	<b>G 4x1 Ex AISI 316</b>	1	120 x 120	292 x 253	11.496 x 9.961	4.1	9.039	<b>EXG004000000121</b>
	<b>G 4x2 Ex AISI 316</b>	2	120 x 120	292 x 383	11.496 x 15.079	6.3	13.977	<b>EXG004000000221</b>
	<b>G 4x3 Ex AISI 316</b>	3	120 x 120	292 x 514	11.496 x 20.236	8.6	18.938	<b>EXG004000000321</b>
	<b>G 4x4 Ex AISI 316</b>	4	120 x 120	292 x 644	11.496 x 25.354	10.8	23.898	<b>EXG004000000421</b>
	<b>G 6x1 Ex AISI 316</b>	1	180 x 120	350 x 253	13.780 x 9.961	4.8	10.516	<b>EXG006000000121</b>
	<b>G 6x2 Ex AISI 316</b>	2	180 x 120	350 x 383	13.780 x 15.079	7.3	16.072	<b>EXG006000000221</b>
	<b>G 6x3 Ex AISI 316</b>	3	180 x 120	350 x 514	13.780 x 20.236	9.8	21.627	<b>EXG006000000321</b>
	<b>G 6x4 Ex AISI 316</b>	4	180 x 120	350 x 644	13.780 x 25.354	12.4	27.205	<b>EXG006000000421</b>
	<b>G 8x1 Ex AISI 316</b>	1	240 x 120	410 x 253	16.142 x 9.961	5.5	12.037	<b>EXG008000000121</b>
	<b>G 8x2 Ex AISI 316</b>	2	240 x 120	410 x 383	16.142 x 15.079	8.3	18.210	<b>EXG008000000221</b>
	<b>G 8x3 Ex AISI 316</b>	3	240 x 120	410 x 514	16.142 x 20.236	11.1	24.405	<b>EXG008000000321</b>
	<b>G 8x4 Ex AISI 316</b>	4	240 x 120	410 x 644	16.142 x 25.354	13.9	30.578	<b>EXG008000000421</b>

# G Ex frames, technical information

Telaio G Ex, informazioni tecniche | G Ex Rahmen, technische Daten | Marcos G Ex, información técnica | Cadre G Ex, informations techniques

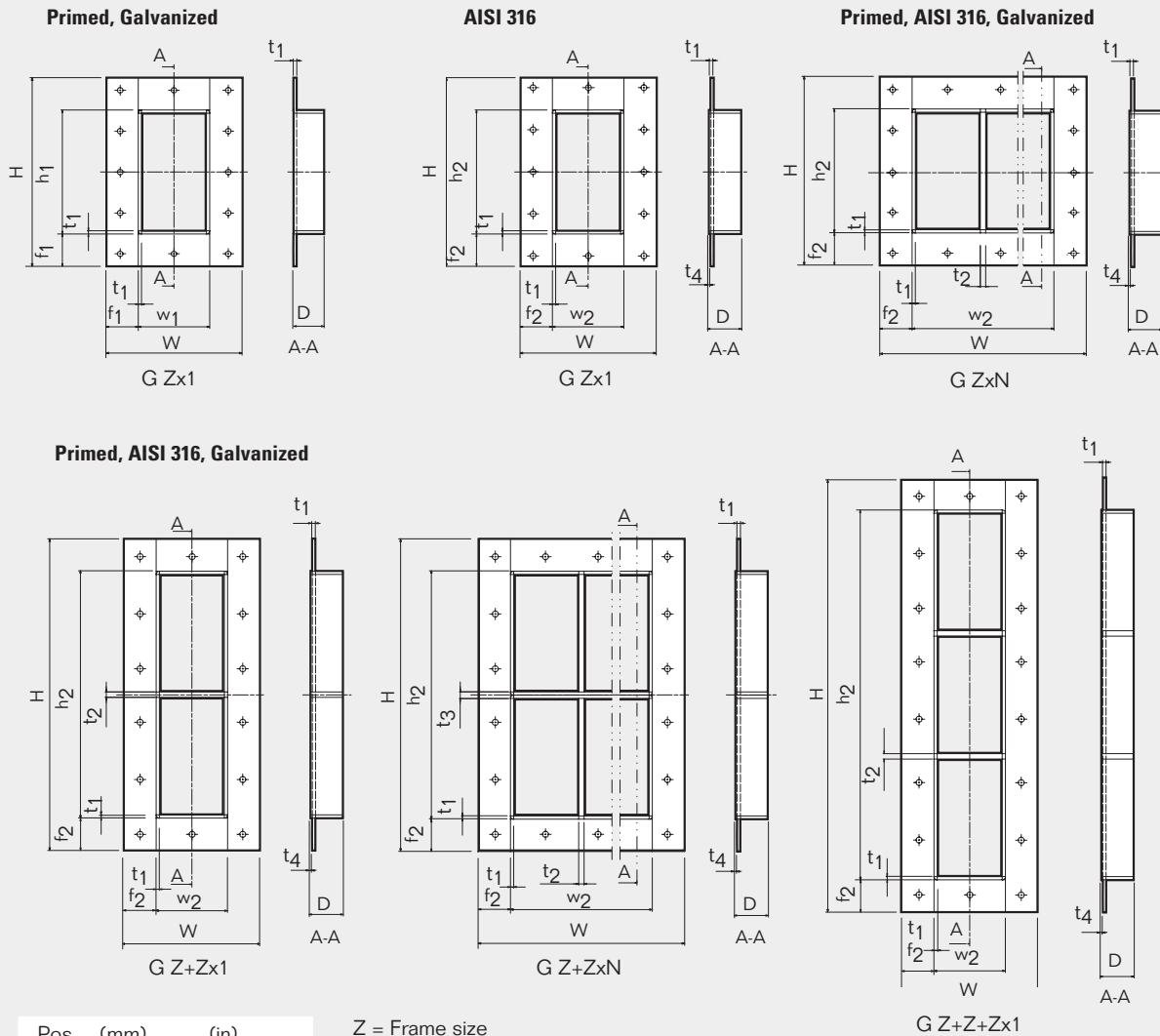

Pos	(mm)	(in)
h <sub>1</sub>	H - 108	H - 4.252
h <sub>2</sub>	H - 120	H - 4.724
w <sub>1</sub>	W - 108	W - 4.274
w <sub>2</sub>	W - 120	W - 4.724
D	60	2.362
f <sub>1</sub>	54	2.126
f <sub>2</sub>	60	2.362
t <sub>1</sub>	6	0.263
t <sub>2</sub>	10	0.394
t <sub>3</sub>	12	0.394
t <sub>4</sub>	3	0.118

Z = Frame size  
N = Number of horizontal openings

Z = Grandezza telaio  
N = Numero delle aperture orizzontali

Z = Rahmengröße  
N = Anzahl horizontaler Öffnungen

Z = Tamaño del marco  
N = Número de aberturas en sentido horizontal

Z = Taille du cadre  
N = Nombre d'alvéoles horizontales

Note: All dimensions are nominal values  
Nota: tutte le dimensioni sono valori nominali  
Achtung: Alle angegebenen Maße sind Nominalwerte  
Nota: Todas las dimensiones son valores nominales  
N.B.: toutes les dimensions sont nominales

# CF 8 Ex/CF 32 Ex frames



**GB** The Roxtec CF 8 Ex and CF 32 Ex are cast aluminium frames suitable for compact installations in cabinets. The compression is integrated in the frame. CF 8 Ex can accommodate up to 15 cables and CF 32 Ex up to 60 cables.

**IT** I telai Roxtec CF 8 Ex e CF 32 Ex sono in alluminio pressofuso adatti in installazioni compatte in quadri. La compressione è integrata nel telaio. Il telaio CF 8 Ex può contenere fino a 15 cavi, mentre il telaio CF 32 Ex fino a 60 cavi.

**DE** Die Roxtec CF 8 Ex und CF 32 Ex Rahmen sind Aluminium-Rahmen, geeignet für kompakte Installationen in Gehäusen. Die Kompressionseinheit ist in den Rahmen integriert. Der CF 8 Ex kann bis zu 15 Kabel und der CF 32 Ex bis zu 60 Kabel aufnehmen.

**ES** Los CF 8 Ex y CF 32 Ex de Roxtec son marcos de aluminio para empotrar, apropiados para instalaciones compactas en armarios. La compresión viene integrada en el marco. El CF 8 Ex puede sellar hasta 15 cables y el CF 32 Ex hasta 60 cables.

**FR** Les cadres Roxtec CF8 Ex/CF32 Ex sont en aluminium et nickelé en surface pour des installations compactes dans des armoires et coffrets. L'unité de compression est intégrée au cadre. Le CF8 Ex peut accepter jusqu'à 15 câbles et le CF32 Ex jusqu'à 60 câbles.

# CF 8 Ex / CF 32 Ex frame, integrated compression unit, aluminium

Telai CF 8 Ex / CF 32 Ex, unità di compressione integrata, alluminio ▶ CF 8 Ex / CF 32 Ex Rahmen, integrierte Kompressionseinheit, Aluminium ▶ Marcos CF 8 Ex/CF 32 Ex, unidad de compresión integrada, aluminio ▶ Cadres CF 8 Ex / CF 32 Ex, unité de compression intégrée, aluminium nickelé en surface



**CF 8 Ex**  
EXCSF0000080035

**CF 32 Ex**  
EXCSF0000320035

Parts needed for a complete solution



page 39

**Cert. No:** IECEx SP 09.0001X, SP08ATEX3916X, **ATEX:** II 2GD Ex e II Ex tD A21, **IP Class:** 66/67, **Temp:** -40°C — +80°C

IT	Telaio	Apertura telaio	Spazio di riempimento (mm)	Dimensioni esterne		Peso		Art. Nr.
				HxW (mm)	HxW (tum)	(kg)	(lb)	
DE	Rahmen	Rahmenöffnungen	Belegraum (mm)	Außenmaße		Gewicht		Art.-Nr.
				HxW (mm)	HxW (in.)	(kg)	(lb.)	
ES	Marco	Aberturas del marco	Espacio útil de sellado (mm)	Dim. externas		Peso		Nº art.
				HxW (mm)	HxW (pulgadas)	(kg)	(libra)	
FR	Cadre	Nombre d'alvéoles	Espace de remplissage (mm)	Dim. Extérieures		Poids		Nº d'article
				HxW (mm)	HxW (pouces)	(kg)	(lb)	
GB	Frame	Frame openings	Packing space (mm)	External dimensions		Weight		Art. No.
				HxW (mm)	HxW (in)	(kg)	(lb)	
	<b>CF 8 Ex</b>	1	80 x 40	140 x 75	5.512 x 2.952	0.6	1.323	<b>EXCSF0000080035</b>
	<b>CF 32 Ex</b>	2	160 x 40	230 x 130	9.055 x 5.118	1.4	3.086	<b>EXCSF0000320035</b>

**CF 8 Ex**

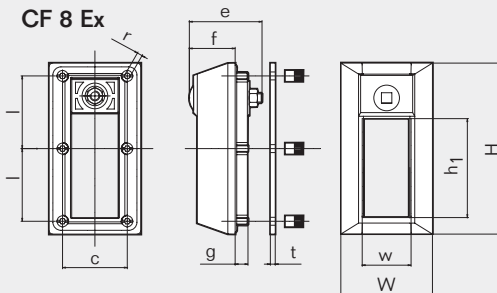

**CF 32 Ex**

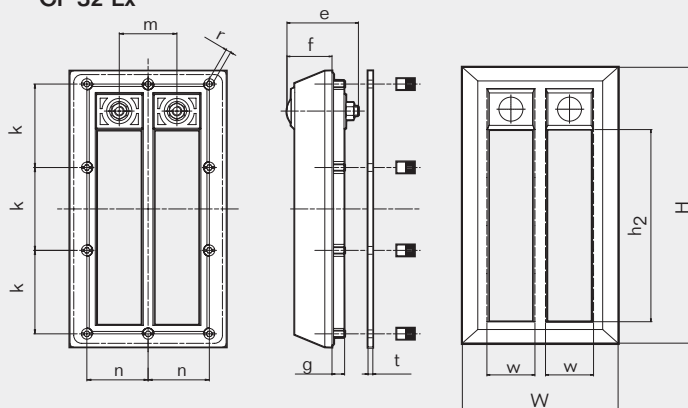

Pos	(mm)	(in)
l	60	2.362
r	SW 4	SW 0.157
c	53	2.087
e	59	2.323
f	38	1.496
g	12	0.472
k	70	2.756
m	48	1.890
n	51	2.008
t	4	0.157
h <sub>1</sub>	80	3.150
h <sub>2</sub>	160	6.299
w	40	1.575

Note: All dimensions are nominal values  
 Nota: tutte le dimensioni sono valori nominali  
 Achtung: alle angegebenen Maße sind Nominalwerte  
 Nota: Todas las dimensiones son valores nominales  
 N.B.: toutes les dimensions sont nominales

# CF 16 Ex frame



**GB** The CF 16 Ex frame has a very low profile and is suitable for enclosures where many cables need to be routed in areas with limited space. The CF 16 Ex has integrated compression and is ready to accommodate up to 30 cables.

**IT** Il telaio CF 16 Ex ha un profilo estremamente basso ed è ideale per applicazioni su quadri dove sia necessario far passare molti cavi in poco spazio. CF 16 Ex è dotato di compressione integrata e può contenere fino a 30 cavi.

**DE** Der CF 16 Ex Rahmen hat ein sehr flaches Profil und ist für Gehäuse geeignet, in die viele Kabel auf geringem Raum eingeführt werden sollen. Der CF 16 Ex hat eine integrierte Kompressionseinheit und kann bis zu 30 Kabel aufnehmen.

**ES** El marco CF 16 Ex tiene un perfil muy bajo y es adecuado para cajas de protección en las que es necesario conducir muchos cables en áreas de espacio reducido. El CF 16 Ex tiene compresión integrada y está preparado para alojar hasta 30 cables.

**FR** Le cadre CF 16 Ex a un profil très bas et est indiqué pour les enveloppes dans lesquelles de nombreux câbles doivent être acheminés à des endroits où l'espace est limité. Le CF 16 Ex est équipé d'une compression intégrée et peut accepter jusqu'à 30 câbles.

# CF 16 Ex frames

Telai CF 16 Ex » CF 16 Ex Rahmen » Marco CF 16 Ex » Cadre CF 16 Ex



**CF 16 Ex**  
EXCSF0000160010



**CF 16 Ex AISI 304**  
EXCSF0001600021

Parts needed for a complete solution



page 39

Cert. No: IECEx SP 09.0001X, SP08ATEX3917X, ATEX: II 2GD Ex e II Ex tD A21, IP Class: 66/67, Temp: -60 — +80°C

	Telaio	Aperture telaio	Spazio di riempimento (mm)	Dimensioni esterne		Peso		Art. Nr.
				HxW (mm)	HxW (tum)	(kg)	(lb)	
DE	Rahmen	Rahmenöffnungen	Belegraum (mm)	Außenmaße		Gewicht		Art.-Nr.
ES	Marco	Aberturas del marco	Espacio útil de sellado (mm)	Dim. externas		Peso		Nº art.
FR	Cadre	Nombre d'alvéoles	Espace de remplissage (mm)	Dim. Extérieures		Poids		Nº d'article
GB	Frame	Frame openings	Packing space (mm)	External dimensions		Weight		Art. No.
				HxW (mm)	HxW (in)	(kg)	(lb)	
	<b>CF 16 Ex</b>	1	160 x 40	234 x 93	9.213 x 3.661	1.4	3.086	<b>EXCSF0000160010</b>
	<b>CF 16 Ex AISI 304</b>	1	160 x 40	234 x 93	9.213 x 3.661	1.2	2.646	<b>EXCSF0000160021</b>

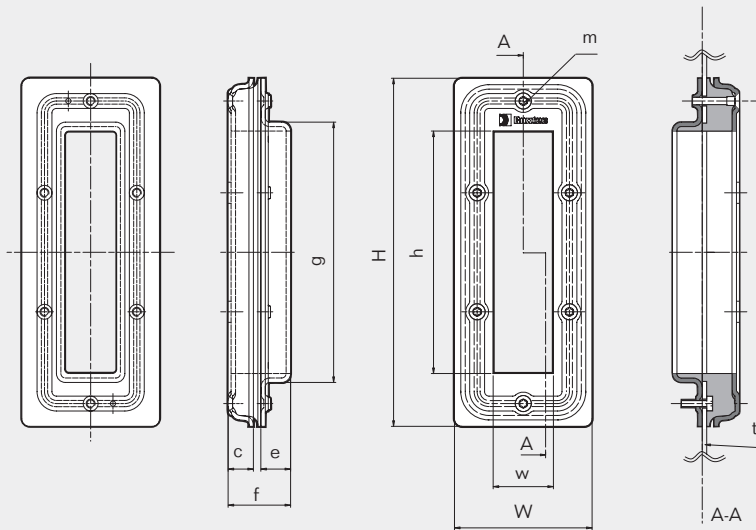

Pos	(mm)	(in)
c	17	0.669
e	20	0.787
f	42	1.654
g	175	6.890
h	160	6.299
m	SW TX 25	SW TX 25
t	Max 4 mm	Max 0.157
w	40	1.575

Note: All dimensions are nominal values  
 Nota: tutte le dimensioni sono valori nominali  
 Achtung: alle angegebenen Maße sind Nominalwerte  
 Nota: Todas las dimensiones son valores nominales  
 N.B. : toutes les dimensions sont nominales

# R Ex

**GB** The Roxtec R Ex is a round expansion frame with a square packing space. The kit includes a sleeve. The sleeves are available in two versions intended for welding or bolting into place. Sleeves with flange has gasket included. The compression is integrated in the frame and is used together with RM Ex modules. R Ex frames are supplied with a net installed (except R 75 Ex) on the back side as protection during horizontal installations.

**ES** El R Ex de Roxtec es un marco de expansión redondo con una abertura cuadrada. El kit incluye un collarín. Los collarines están disponibles en dos versiones, para soldar o atornillar en el lugar de instalación. Los collarines de expansión tienen una culata de goma. La compresión está integrada en el marco y se completa con módulos RM Ex. Los marcos R Ex se suministran con una red (excepto el R 75 Ex) en su parte posterior como medida de protección en las instalaciones horizontales.

**IT** Il telaio R Ex di Roxtec è un telaio ad espansione circolare con un'apertura quadrata. Il kit include il manicotto. I manicotti sono disponibili in due versioni a seconda dell'applicazione (a saldare o ad imbullonare). La compressione è integrata nel telaio che va utilizzato insieme ai moduli RM Ex. I telai R vengono forniti con una rete installata sul fondo (eccetto R-75 Ex) come supporto durante le installazioni orizzontali.

**FR** Le cadre R Ex Roxtec est une bague circulaire avec une ouverture carrée. Le kit inclut une douille. La bague est disponible en deux versions pour des installations soudées ou boulonnées. Les douilles avec épaulement sont équipées d'un joint plat. Le système de compression est intégré à la bague qui s'utilise avec des modules RM Ex. Les bagues R Ex sont livrées avec un filet protecteur situé à l'arrière (sauf R75 Ex) pour faciliter des installations horizontales.

**DE** Der Roxtec R Ex ist ein Expansionsrahmen mit einer viereckigen Öffnung. Das Set beinhaltet ein Mantelrohr. Das Mantelrohr ist in zwei Ausführungen erhältlich: zum Einschweißen oder Aufschrauben. Die Mantelrohre mit Flansch haben eine Dichtung. Der Rahmen verfügt über integrierte Spannschläge und wird mit RM Ex Modulen ausgefüllt. R Ex Rahmen werden mit einem StopNet (außer R 75 Ex) auf der Rückseite geliefert, das zum Schutz beim horizontalen Einbau dient.





# R...W Ex including sleeve for welding

Telai R, per applicazioni a saldare componenti galvanizzati » R...W Ex, inkl. Mantelrohr zum Einschweißen »  
 R...W Ex incl. collarín para soldar » Bague R...W Ex avec douille pour installations soudées



Parts needed for a complete solution

page 39

**R 100 W Ex AISI 316/primed**  
 EXWR00001002112

**R 100 W Ex AISI 316/AISI 316**  
 EXWR00001002112

For information about other frame sizes that are not standard, please contact your local Roxtec supplier or e-mail: info@roxtec.com

Cert. No: IECEx SP 09.0002U, SP08ATEX3919U, ATEX: II 2GD Ex e II Ex tD A21, IP Class: 66/68, Temp: -60 — +80°C

	Spazio di riempimento (mm)	Dimensioni esterne			Peso		Art. Nr.	
<b>IT</b>	Telaio	ØxD (mm)	ØxD (in)		(kg)	(lb)		
<b>DE</b>	Rahmen	Außenmaße			Gewicht		Art.-Nr.	
<b>ES</b>	Marco	ØxD (mm)	ØxD (in)		(kg)	(lb)		
<b>FR</b>	Bague	Dim. extérieures			Poids		N° d'article	
<b>GB</b>	Frame	ØxD (mm)	ØxD (in)	Sleeve SLR*	(kg)	(lb)	Art. No.	
	with primed mild steel sleeve							
	<b>R 75 W Ex AISI 316/primed</b>	40 x 40	75 x 70	2.953 x 2.756	75	1.3	2.866	<b>EXWR00000752112</b>
	<b>R 100 W Ex AISI 316/primed</b>	60 x 60	100 x 70	3.937 x 3.346	100	1.7	3.748	<b>EXWR00001002112</b>
	<b>R 125 W Ex AISI 316/primed</b>	80 x 80	125 x 70	4.921 x 2.756	125	2.7	5.952	<b>EXWR00001252112</b>
	<b>R 150 W Ex AISI 316/primed</b>	90 x 90	150 x 70	5.906 x 2.756	150	3.5	7.716	<b>EXWR00001502112</b>
	<b>R 200 W Ex AISI 316/primed</b>	120 x 120	200 x 70	7.874 x 2.756	200	5.3	11.684	<b>EXWR00002002112</b>
	with acid proof stainless steel sleeve							
	<b>R 75 W Ex AISI 316/AISI 316</b>	40 x 40	75 x 70	2.953 x 2.756	75	1.3	2.866	<b>EXWR00000752121</b>
	<b>R 100 W Ex AISI 316/AISI 316</b>	60 x 60	100 x 70	3.937 x 3.346	100	1.7	3.748	<b>EXWR00001002121</b>
	<b>R 125 W Ex AISI 316/AISI 316</b>	80 x 80	125 x 70	4.921 x 2.756	125	2.7	5.952	<b>EXWR00001252121</b>
	<b>R 150 W Ex AISI 316/AISI 316</b>	90 x 90	150 x 70	5.906 x 2.756	150	3.5	7.716	<b>EXWR00001502121</b>
	<b>R 200 W Ex AISI 316/AISI 316</b>	120 x 120	200 x 70	7.874 x 2.756	200	5.3	11.684	<b>EXWR00002002121</b>

\* More information about sleeves on page 68

## R...B Ex including sleeve for bolting

Telai R, per applicazioni ad imbullonare componenti galvanizzati » R...B Ex, inkl. Mantelrohr zum Aufschrauben »  
R...B Ex incl. collarín para atornillar » Bague R...B Ex avec douille pour installations boulonnées



Parts needed for a complete solution



page 39

**R 100 B Ex AISI 316/primed**  
EXBR00001002112

**R 100 B Ex AISI 316/AISI 316**  
EXBR00001002121

For information about other frame sizes that are not standard, please contact your local Roxtec supplier or e-mail: [info@roxtec.com](mailto:info@roxtec.com)

Cert. No: IECEx SP 09.0001X, SP08ATEX3918X, ATEX: II 2GD Ex e II Ex tD A21, IP Class: 66/68, Temp: -60 — +80°C

IT	Telaio	Spazio di riempimento (mm)	Dimensioni esterne		Sleeve SLFR*	Peso		Art. Nr.
			ØxD (mm)	ØxD (in.)		(kg)	(lb)	
DE	Rahmen	Belegraum (mm)	Außenmaße			Gewicht		Art.-Nr.
			ØxD (mm)	ØxD (in.)		(kg)	(lb)	
ES	Marco	Espacio útil de sellado (mm)	Dim. externas			Peso		Nº art.
			ØxD (mm)	ØxD (pulgadas)		(kg)	(libra)	
FR	Bague	Espace de remplissage (mm)	Dim. Extérieures			Poids		Nº d'article
			ØxD (mm)	ØxD (pouces)		(kg)	(lb)	
GB	Frame	Packing space (mm)	External dimensions		Sleeve SLFR*	Weight		Art. No.
			ØxD (mm)	ØxD (in)		(kg)	(lb)	
	with primed mild steel sleeve							
	<b>R 75 B Ex AISI 316/primed</b>	40 x 40	75 x 70	2.953 x 2.756	75	1.8	3.968	<b>EXBR00000752112</b>
	<b>R 100 B Ex AISI 316/primed</b>	60 x 60	100 x 70	3.937 x 3.346	100	2.4	5.291	<b>EXBR00001002112</b>
	<b>R 125 B Ex AISI 316/primed</b>	80 x 80	125 x 70	4.921 x 2.756	125	3.5	7.716	<b>EXBR00001252112</b>
	<b>R 150 B Ex AISI 316/primed</b>	90 x 90	150 x 70	5.906 x 2.756	150	4.3	9.480	<b>EXBR00001502112</b>
	<b>R 200 B Ex AISI 316/primed</b>	120 x 120	200 x 70	7.874 x 2.756	200	6.4	14.110	<b>EXBR00002002112</b>
	with acid proof stainless steel sleeve							
	<b>R 75 B Ex AISI 316/AISI 316</b>	40 x 40	75 x 70	2.953 x 2.756	75	1.8	3.968	<b>EXBR00000752121</b>
	<b>R 100 B Ex AISI 316/AISI 316</b>	60 x 60	100 x 70	3.937 x 3.346	100	2.4	5.291	<b>EXBR00001002121</b>
	<b>R 125 B Ex AISI 316/AISI 316</b>	80 x 80	125 x 70	4.921 x 2.756	125	3.5	7.716	<b>EXBR00001252121</b>
	<b>R 150 B Ex AISI 316/AISI 316</b>	90 x 90	150 x 70	5.906 x 2.756	150	4.3	9.480	<b>EXBR00001502121</b>
	<b>R 200 B Ex AISI 316/AISI 316</b>	120 x 120	200 x 70	7.874 x 2.756	200	6.4	14.110	<b>EXBR00002002121</b>

\* More information about sleeves on page 68

# R Ex frame, technical information

Telaio R Ex, informazioni tecniche | R Ex Rahmen, technische Daten | Marco R Ex, información técnica | Bague R Ex, informations techniques

R 75 Ex

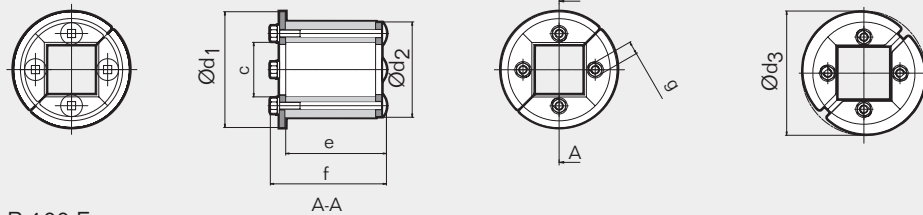

R 100 Ex

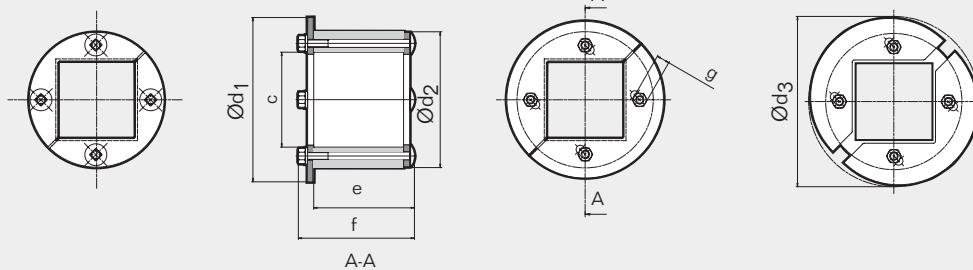

R 125 Ex / R 150 Ex / R 200 Ex

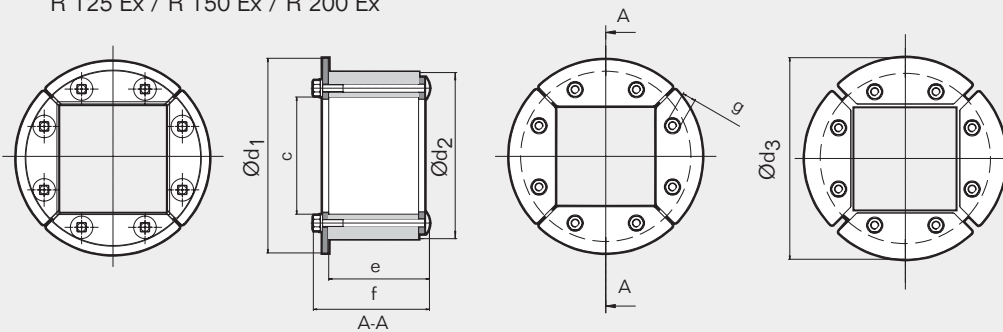

	R 75 Ex		R 100 Ex		R 125 Ex		R150 Ex		R200 Ex	
Pos	(mm)	(in)	(mm)	(in)	(mm)	(in)	(mm)	(in)	(mm)	(in)
c (□)	40	1.575	60	2.362	80	3.150	90	3.543	120	4.724
e	72	2.835	75	2.953	75	2.953	75	2.953	75	2.953
f	85	3.346	85	3.346	85	3.346	91	3.583	91	3.583
g	*	*	*	*	**	**	***	***	***	***
Ød <sub>1</sub>	85	3.346	115	4.528	142	5.591	165	6.496	215	8.465
Ød <sub>2</sub>	75	2.953	100	3.937	125	4.921	150	5.906	200	7.874
Ød <sub>3</sub>	91	3.583	125	4.921	148	5.827	171	6.732	223	8.780

\* SW10 mm (4x) / SW0.394" (4x)    \*\* SW10 mm (8x) / SW0.394 (8x)    \*\*\* SW13 mm (8x) / SW0.512 (8x)

f = Dimension with front fittings in outer position  
 Dimensioni con i listelli frontali in posizione esterna  
 Außenabmessungen der Beschläge  
 Medidas con los los componentes delanteros en posición externa  
 Dimension avec les ferrures-avants métalliques en position écartée

Note: All dimensions are nominal values  
 Nota: tutte le dimensioni sono valori nominali  
 Achtung: alle angegebenen Maße sind Nominalwerte  
 Nota: Todas las dimensiones son valores nominales  
 N.B. : toutes les dimensions sont nominales

# Sleeves, technical information

Manicotti, informazioni tecniche » Mantelrohre, technische Daten » Collarines, información técnica »  
 Douilles, informations techniques

## Without flange

Primed mild steel/Acid proof AISI 316

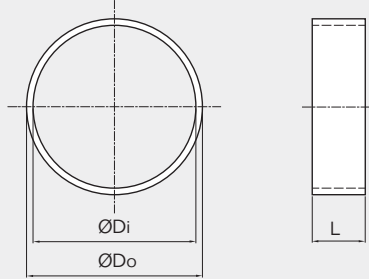

	SLR 75		SLR 100		SLR 125		SLR 150		SLR 200	
Pos	(mm)	(in)	(mm)	(in)	(mm)	(in)	(mm)	(in)	(mm)	(in)
ØDo	89	3,504	114	4,488	140	5,512	164	6,457	214	8,425
ØDi	76,5	3,012	101	3,976	126	4,961	151	5,945	201	7,913
L	55	2,165	55	2,165	55	2,165	55	2,165	55	2,165

## With flange

Primed mild steel/Acid proof AISI 316

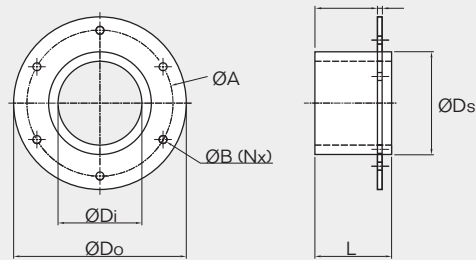

	SLFR 70		SLFR 100		SLFR 125		SLFR 150		SLFR 200	
Pos	(mm)	(in)	(mm)	(in)	(mm)	(in)	(mm)	(in)	(mm)	(in)
ØDo	160	6,288	195	7,677	213	8,371	236	9,291	290	11,417
ØDi	71,5	2,815	101	3,976	126	4,961	151	5,945	201	7,913
ØB	9	0,354	9	0,354	9	0,354	9	0,354	9	0,354
(Nx)	4x		6x		6x		6x		8x	
ØA	130	5,118	165	6,496	183	7,205	206	8,110	260	10,236
L	55	2,165	55	2,165	55	2,165	55	2,165	55	2,165
l	43	1,692	43	1,692	43	1,692	43	1,692	43	1,692
ØDs	83	3,268	114	4,488	140	5,512	164	6,457	214	8,425
T	4	0,157	4	0,157	4	0,157	4	0,157	4	0,157

# RS Ex



**GB** The Roxtec RS Ex is a round entry seal including a sleeve. The seal consists of two halves and an adaptable centre with removable layers. Compression is integrated in the seal.

- The sleeves are available in two design versions intended for welding or bolting into place.
- Available in EMC versions.

**ES** El RS Ex de Roxtec es un sello redondo que incluye un collarín. El sello está compuesto por dos mitades y un centro adaptable con capas desmontables. La compresión está integrada en el sello.

- Los collarines están disponibles en dos versiones con adhesión por atomilladura o soldadura.
- Disponible en versiones EMC.

**IT** Roxtec RS Ex è un passaggio per ingresso circolare comprensivo di manicotto. La guarnizione è composta da due metà e da una parte centrale adattabile con strati rimovibili. La compressione è integrata nella guarnizione.

- I manicotti sono disponibili in 2 versioni diverse, destinate alla saldatura o alla bullonatura.
- Disponibile nelle versioni EMC.

**FR** La bague circulaire RS Ex de Roxtec comprend une douille. La bague se compose de deux moitiés et d'un centre adaptable constitué de couches pelables. L'unité de compression est intégrée à la bague.

- Les douilles sont disponibles en deux versions pour des installations soudées ou boulonnées.
- Existe aussi en versions CEM.

**DE** Der Roxtec RS Ex ist eine runde Durchführung mit Mantelrohr. Die Dichtung besteht aus zwei Hälften mit herausnehmbaren Lagen. Die Kompressionseinheit ist in die Dichtung integriert.

- Das Mantelrohr ist in zwei Ausführungen erhältlich: zum Einschweißen oder Anschrauben.
- Erhältlich in EMC-Versionen.

# RS...W Ex including sleeve for welding

Passaggio circolare RS, parti in acciaio inox resistente agli acidi, con nucleo per applicazioni a saldare 》

RS ...W Ex, inkl. Mantelrohr zum Einschweißen 》 RS...W Ex incl. collarín para soldar 》

Bague RS...W Ex avec douille pour installations soudées



**R 100 W Ex AISI 316 woc\*\*/primed**  
EXRSW0100102112

**RS 75 W Ex AISI 316/AISI 316**  
EXRSW0750102121

For information about other sizes that are not standard, please contact your local Roxtec supplier or e-mail: [info@roxtec.com](mailto:info@roxtec.com)

**Cert. No:** IECEx SP 09.0002U, SP08ATEX3915U, **ATEX:** II 2GD Ex e II Ex tD A21, **IP Class:** 66/68, **Temp:** -60 — +80°C

	Per cavo/tubo (mm)   (in)		Dimensioni esterne ØxD (mm)   ØxD (in)		Sleeve SLRS*	Peso (kg)   (lb)		Art. Nr.
	Für Kabel/Rohr (mm)   (in.)		Außenmaße ØxD (mm)   ØxD (in.)			Gewicht (kg)   (lb)		
IT Passaggio circolare								
DE Stopfen								Art.-Nr.
ES Sello	Para cable/tubería (mm)   (pulgadas)		Dim. externas ØxD (mm)   ØxD (pulgadas)			Peso (kg)   (libra)		Nº art.
FR Bague	Pour câble/tuyauterie (mm)   (pouces)		Dimensions extérieures ØxD (mm)   ØxD (pouces)			Poids (kg)   (lb)		Nº d'article
GB Seal	For cable/pipe (mm)   (in)		External dimensions ØxD (mm)   ØxD (in)		Sleeve SLRS*	Weight (kg)   (lb)		Art. No.
with primed mild steel sleeve								
<b>RS 25 W Ex AISI 316/primed</b>	0+3.6-12	0+0.142-0.472	25 x 40	0.984 x 1.575	25	0.1	0.306	<b>EXRSW0250002112</b>
<b>RS 43 W Ex AISI 316/primed</b>	0+4-23	0+0.157-0.906	43 x 78	1.693 x 3.071	43	0.5	1.203	<b>EXRSW0430002112</b>
<b>RS 50 W Ex AISI 316/primed</b>	0+8-30	0+0.315-1.181	50 x 78	1.969 x 3.071	50	0.8	1.840	<b>EXRSW0500002112</b>
<b>RS 75 W Ex AISI 316/primed</b>	0+26-48	0+1.024-1.890	75 x 78	2.953 x 3.071	75	1.5	3.359	<b>EXRSW0750002112</b>
with acid proof stainless steel sleeve								
<b>RS 100 W Ex AISI 316 woc**/primed</b>	48-70	1.890-2.756	100 x 83	3.937 x 3.268	100	2.0	4.504	<b>EXRSW0100102112</b>
<b>RS 125 W Ex AISI 316 woc**/primed</b>	66-98	2.598-3.858	125 x 83	4.921 x 3.268	125	2.7	6.025	<b>EXRSW0125102112</b>
<b>RS 150 W Ex AISI 316 woc**/primed</b>	93-119	3.661-4.685	150 x 85	5.906 x 3.346	150	3.2	7.012	<b>EXRSW0150102112</b>
<b>RS 25 W Ex AISI 316/AISI 316</b>	0+3.6-12	0+0.142-0.472	25 x 40	0.984 x 1.575	25	0.1	0.306	<b>EXRSW0250002121</b>
<b>RS 43 W Ex AISI 316/AISI 316</b>	0+4-23	0+0.157-0.906	43 x 78	1.693 x 3.071	43	0.5	1.203	<b>EXRSW0430102121</b>
<b>RS 50 W Ex AISI 316/AISI 316</b>	0+8-30	0+0.315-1.181	50 x 78	1.969 x 3.071	50	0.8	1.840	<b>EXRSW0500002121</b>
<b>RS 75 W Ex AISI 316/AISI 316</b>	0+26-48	0+1.024-1.890	75 x 78	2.953 x 3.071	75	1.5	3.359	<b>EXRSW0750102121</b>
<b>RS 100 W Ex AISI 316 woc**/AISI 316</b>	48-70	1.890-2.756	100 x 83	3.937 x 3.268	100	2.0	4.504	<b>EXRSW0100102121</b>
<b>RS 125 W Ex AISI 316 woc**/AISI 316</b>	66-98	2.598-3.858	125 x 83	4.921 x 3.268	125	2.7	6.025	<b>EXRSW0125102121</b>
<b>RS 150 W Ex AISI 316 woc**/AISI 316</b>	93-119	3.661-4.685	150 x 85	5.906 x 3.346	150	3.2	7.012	<b>EXRSW0150102121</b>

\* More information about SLRS sleeves on page 73

\*\* woc = without core

# RS...B Ex including sleeve for bolting

Passaggio circolare RS, parti in acciaio inox resistente agli acidi, con nucleo per applicazioni ad imbullonare »

RS ...B Ex, inkl. Mantelrohr zum Aufschrauben » RS...B Ex incl. collarín para atornillar »

Bague RS...B Ex avec douille pour installations boulonnées



**R 100 B Ex AISI 316 woc\*\*/primed**  
EXRSB0100102112

**RS 75 B Ex AISI 316/AISI 316**  
EXRSB0750002121

For information about other sizes that are not standard, please contact your local Roxtec supplier or e-mail: [info@roxtec.com](mailto:info@roxtec.com)

Cert. No: IECEx SP 09.0001X, SP08ATEX3914X, ATEX: II 2GD Ex e II Ex tD A21, IP Class: 66/68, Temp: -60 — +80°C

IT	Passaggio circolare	Per cavo/tubo		Dimensioni esterne		Peso		Art. Nr.	
		(mm)	(in)	ØxD (mm)	ØxD (in)	(kg)	(lb)		
DE	Stopfen	Für Kabel/Rohr		Außenmaße		Gewicht		Art.-Nr.	
ES	Sello	Para cable/tubería		Dim. externas		Peso			
FR	Bague	Pour câble/tuyauterie		Dimensions extérieures		Poids		N° d'article	
GB	Seal	For cable/pipe		External dimensions		Sleeve	Weight		Art. No.
		(mm)	(in)	ØxD (mm)	ØxD (in)	SLFRS*	(kg)	(lb)	
	with primed mild steel sleeve								
	<b>RS 25 B Ex AISI 316/primed</b>	0+3.6-12	0+0.142-0.472	25 x 40	0.984 x 1.575	25	0.1	0.306	<b>EXRSB0250002112</b>
	<b>RS 43 B Ex AISI 316/primed</b>	0+4-23	0+0.157-0.906	43 x 78	1.693 x 3.071	43	0.5	1.203	<b>EXRSB0430002112</b>
	<b>RS 50 B Ex AISI 316/primed</b>	0+8-30	0+0.315-1.181	50 x 78	1.969 x 3.071	50	0.8	1.840	<b>EXRSB0500002112</b>
	<b>RS 75 B Ex AISI 316/primed</b>	0+26-48	0+1.024-1.890	75 x 78	2.953 x 3.071	75	1.5	3.359	<b>EXRSB0750002112</b>
	<b>RS 100 B Ex AISI 316 woc**/primed</b>	48-70	1.890-2.756	100 x 83	3.937 x 3.268	100	2.0	4.504	<b>EXRSB0100002112</b>
	<b>RS 125 B Ex AISI 316 woc**/primed</b>	66-98	2.598-3.858	125 x 83	4.921 x 3.268	125	2.7	6.025	<b>EXRSB0125102112</b>
	<b>RS 150 B Ex AISI 316 woc**/primed</b>	93-119	3.661-4.685	150 x 85	5.906 x 3.346	150	3.2	7.012	<b>EXRSB0150102112</b>
	with acid proof stainless steel sleeve								
	<b>RS 25 B Ex AISI 316/AISI 316</b>	0+3.6-12	0+0.142-0.472	25 x 40	0.984 x 1.575	25	0.1	0.306	<b>EXRSB0250002121</b>
	<b>RS 43 B Ex AISI 316/AISI 316</b>	0+4-23	0+0.157-0.906	43 x 78	1.693 x 3.071	43	0.5	1.203	<b>EXRSB0430002121</b>
	<b>RS 50 B Ex AISI 316/AISI 316</b>	0+8-30	0+0.315-1.181	50 x 78	1.969 x 3.071	50	0.8	1.840	<b>EXRSB0500002121</b>
	<b>RS 75 B Ex AISI 316/AISI 316</b>	0+26-48	0+1.024-1.890	75 x 78	2.953 x 3.071	75	1.5	3.359	<b>EXRSB0750002121</b>
	<b>RS 100 B Ex AISI 316 woc**/AISI 316</b>	48-70	1.890-2.756	100 x 83	3.937 x 3.268	100	2.0	4.504	<b>EXRSB0100102121</b>
	<b>RS 125 B Ex AISI 316 woc**/AISI 316</b>	66-98	2.598-3.858	125 x 83	4.921 x 3.268	125	2.7	6.025	<b>EXRSB0125102121</b>
	<b>RS 150 B Ex AISI 316 woc**/AISI 316</b>	93-119	3.661-4.685	150 x 85	5.906 x 3.346	150	3.2	7.012	<b>EXRSB0150002121</b>

\* More information about SLFRS sleeves on page 73

\*\* woc = without core

# RS Ex seal, technical information

Passaggio circolare RS Ex, informazioni tecniche | RS Ex Stopfen, technische Daten  
 | Sello RS Ex, información técnica | Bague RS, informations techniques

RS 25 Ex / RS 43 Ex / RS 50 Ex / RS 75 Ex

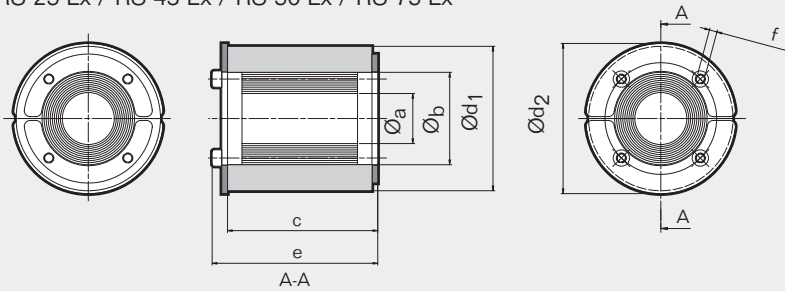

Note: All dimensions are nominal values  
 Nota: tutte le dimensioni sono valori nominali  
 Achtung: alle angegebenen Maße sind Nominalwerte  
 Nota: Todas las dimensiones son valores nominales  
 N.B.: toutes les dimensions sont nominales

Pos	RS 25		RS 43		RS 50		RS 75	
	(mm)	(in)	(mm)	(in)	(mm)	(in)	(mm)	(in)
c	40	1.575	78	3.071	78	3.071	78	3.071
e	44	1.732	85	3.346	85	3.346	85	3.346
f	*	*	**	**	**	**	**	**
Øa	3.6	0.142	4	0.157	8	0.315	26	1.024
Øb	12	0.472	23	0.906	30	1.181	48	1.890
Ød1	25	0.984	43	1.693	50	1.969	75	2.953
Ød2	30	1.181	53	2.087	60	2.362	78	3.071

\* SW2.5 mm (4x) / SW0.098" (4x) \*\* SW4 mm (4x) / SW0.157" (4x)

RS 100 Ex, RS 100 Ex woc / RS 125 Ex, RS 125 Ex woc

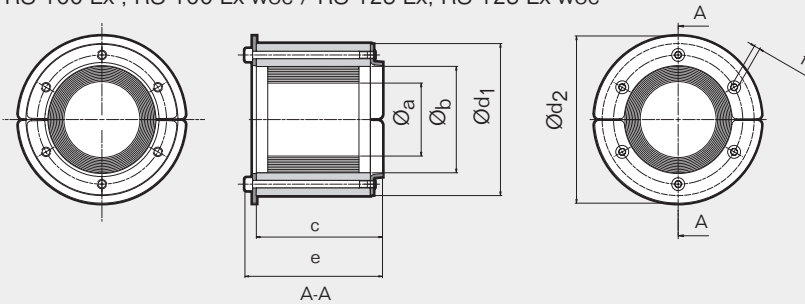

Pos	RS 100 (woc)		RS 125 (woc)	
	(mm)	(in)	(mm)	(in)
c	83	3.268	83	3.268
e	90	3.543	92	3.622
f	***	***	****	****
Øa	48	1.890	66	2.598
Øb	70	2.756	98	3.858
Ød1	100	3.937	125	4.921
Ød2	110	4.331	145	5.709

\*\*\* SW4 mm (6x) / SW0.157" (6x)  
 \*\*\*\* SW5 mm (6x) / SW0.197" (6x)

RS 150 Ex woc

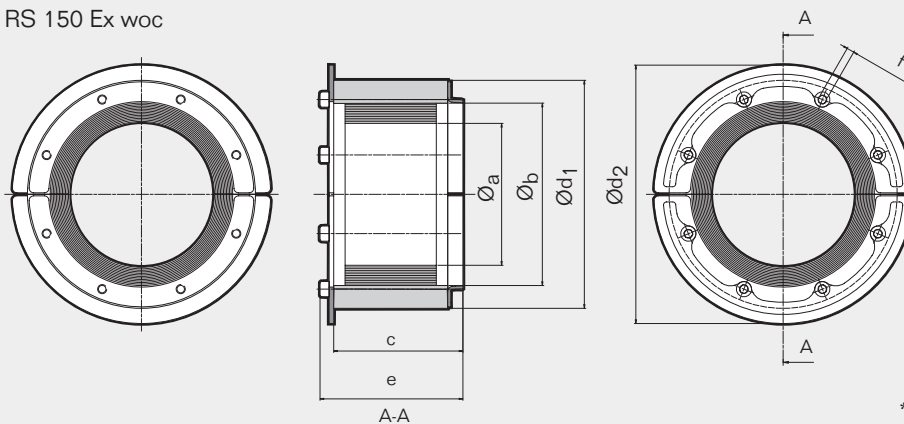

Pos	RS 150 woc	
	(mm)	(in)
c	85	3.346
e	94	3.700
f	*****	*****
Øa	93	3.661
Øb	119	4.685
Ød1	150	5.906
Ød2	170	6.693

\*\*\*\*\* SW5 mm (8x) / SW0.197" (8x)



# Sleeves, technical information

Manicotti, informazioni tecniche » Mantelrohre, technische Daten » Collarines, información técnica  
 » Douilles, informations techniques

## Without flange

Primed mild steel/Acid proof AISI 316

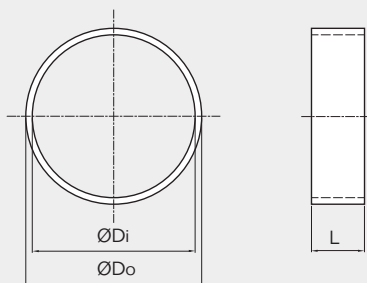

	SLRS 25		SLRS 43		SLRS 50		SLRS 75	
Pos	(mm)	(in)	(mm)	(in)	(mm)	(in)	(mm)	(in)
ØDo	34	1,339	52	2,047	63	2,480	89	3,504
ØDi	25,5	1,004	44	1,732	51	2,008	76,5	3,012
L	35	1,378	65	2,559	65	2,559	65	2,559

	SLRS 100		SLRS 125		SLRS 150	
Pos	(mm)	(in)	(mm)	(in)	(mm)	(in)
ØDo	164	6,457	114	4,488	140	5,512
ØDi	151	5,945	101	3,976	126	4,961
L	65	2,559	65	2,559	65	2,559

## With flange

Primed mild steel/Acid proof AISI 316

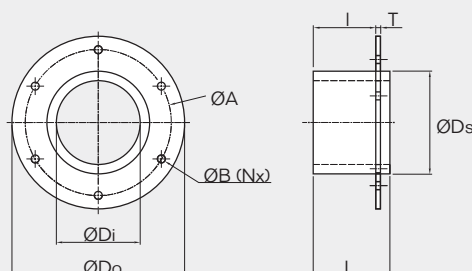

	SLFRS 25		SLFRS 43		SLFRS 50		SLFRS 75		SLFRS 100		SLFRS 125		SLFRS 150	
Pos	(mm)	(in)	(mm)	(in)	(mm)	(in)	(mm)	(in)	(mm)	(in)	(mm)	(in)	(mm)	(in)
ØDo	96	3,780	110	4,331	140	5,512	165	6,496	195	7,677	213	8,386	236	9,291
ØDi	25,5	1,004	44	1,732	51	2,008	76	3,012	101	3,976	126	4,961	151	5,945
ØB	9	0,354	9	0,354	9	0,354	9	0,354	9	0,354	9	0,354	9	0,354
(Nx)	4x		4x		4x		4x		6x		6x		6x	
ØA	72	2,835	80	3,150	110	4,331	135	5,351	165	6,496	183	7,205	206	8,110
L	35	1,378	35	1,378	65	2,559	65	2,559	65	2,559	65	2,559	65	2,559
I	24	0,944	24	0,944	53	2,086	53	2,086	53	2,086	53	2,086	53	2,086
ØDs	34	1,339	52	2,047	63	2,480	89	3,504	114	4,488	140	5,512	164	6,457
T	3	0,118	3	0,118	4	0,157	4	0,157	4	0,157	4	0,157	4	0,157

# C RS T Ex seals



**GB** The Roxtec C RS T Ex sealing solution is available in four sizes. Together they seal single cables from Ø3.6 mm to Ø30 mm. The C RS T Ex kits come as a complete sealing solution, containing a threaded sleeve with gasket, a counter nut and a round C RS T seal for a single cable. A Roxtec C RS T Ex kit makes installation of pre-terminated cables easy, for example in cabinet walls and other types of similar structures.

**ES** La solución de sellado C RS T Ex de Roxtec está indicada para el sellado de un solo cable y se presenta en cuatro tamaños que abarcan un intervalo de Ø3,6 mm a Ø30 mm. El kit C RS T Ex es una solución de sellado completa compuesta de un collarín con rosca y junta, contratuerca y un sello redondo C RS T para un solo cable. Dicho kit facilita la instalación en cables ya instalados, por ejemplo, en las paredes de los armarios o en estructuras similares.

**IT** I passaggi Roxtec C RS T Ex, sono disponibili in quattro grandezze, per sigillare un cavo singolo con diametro da 3,6 a 30 mm. I kit C RS T rappresentano una soluzione completa di sigillatura, che comprende un manicotto filettato con una guarnizione, un controdado ed un passaggio circolare C RS T per un cavo singolo. I Kit Roxtec C RS T Ex semplificano la sigillatura di cavi precablati ad esempio attraverso la parete di una cabina o di una struttura simile.

**FR** La bague ROXTEC CRST Ex est disponible en 4 tailles pour des passages uniques allant de 3.6 mm à 30 mm. Le kit CRST se compose d'une douille avec filetage et joint, un anneau de serrage et une bague CRST pour le passage d'un câble. Le kit est conçu pour faciliter l'installation des câbles munis de connecteurs sur des coffrets ou des structures identiques.

**DE** Der Roxtec C RS T Ex Stopfen ist in vier Größen erhältlich, die einzelne Kabel im Durchmesserbereich von 3,6 mm bis 30,0 mm abdichten. Die C RS T Ex Kits werden als komplette Dichtlösung geliefert und beinhalten eine Gewindehülse mit Dichtring, eine Gegenmutter und einen runden C RS T Stopfen zum Abdichten einzelner Kabel. Ein Roxtec C RS T Ex Kit erleichtert das Abdichten von vorkonfektionierten Kabeln, wie sie z.B. in Gehäusewandungen oder ähnlichen Konstruktionen vorkommen.

# C R S T Ex seal, chromed brass

Kit C R S T » C R S T Ex Stopfen » Sello C R S T Ex, latón cromado » Bague CRST Ex



**C R S T 25 Ex**  
EXCRST010025046

**C R S T 31 Ex**  
EXCRST010031046

**C R S T 43 Ex**  
EXCRST010043046

**C R S T 50 Ex**  
EXCRST010050046

Cert. No: IECEx SP 09.0001X, SP08ATEX3913X, ATEX: II 2GD Ex e II Ex tD A21, IP Class: 66/67, Temp: -60 — +80°C

IT	Dimensioni apertura +1/-0 mm (+0.0394"/-0") Ø (mm)   Ø (in)		Per cavo/tubo Ø (mm)   Ø (in)		Dimensioni esterne manicotto ØxD (mm)   ØxD (in)		Peso manicotto (kg)   (lb)		Art. nr.
	Öffnungsabmessungen +1/-0 mm (+0.0394"/-0") Ø (mm)   Ø (in.)		Für Kabel/Rohr Ø (mm)   Ø (in.)		Außenmaß des Mantelrohres ØxD (mm)   ØxD (in.)		Gewicht des Mantelrohres (kg)   (libra)		
DE	Dim. del hueco +1/-0 mm (+0.0394"/-0") Ø (mm)   Ø (pulgadas)		Para cable/tubería Ø (mm)   Ø (pulgadas)		Dim. externas del collarín ØxD (mm)   ØxD (pulgadas)		peso del collarín (kg)   (libra)		Nº art.
	Dim. d'ouverture +1/-0 mm (+0.0394"/-0") Ø (mm)   Ø (pouces)		Pour câble/tuyauterie Ø (mm)   Ø (pouces)		Dimensions extérieures de la douille ØxD (mm)   ØxD (pouces)		Poids douille (kg)   (lb)		
FR	Aperture dim. +1/-0 mm (+0.0394"/-0") Ø (mm)   Ø (in)		For cable/pipe Ø (mm)   Ø (in)		External dimensions sleeve ØxD (mm)   ØxD (in)		Weight sleeve (kg)   (lb)		Art. No.
	Aperture dim. +1/-0 mm (+0.0394"/-0") Ø (mm)   Ø (in)		For cable/pipe Ø (mm)   Ø (in)		External dimensions sleeve ØxD (mm)   ØxD (in)		Weight sleeve (kg)   (lb)		
<b>C R S T 25 Ex</b>	32	1.260	0+3.6-12.0	0+0.142-0.472	39 x 20	1.535 x 0.787	0.1	0.220	<b>EXCRST010025046</b>
<b>C R S T 31 Ex</b>	40	1.575	0+4.0-17.0	0+0.175-0.669	50 x 20	1.969 x 0.787	0.2	0.331	<b>EXCRST010031046</b>
<b>C R S T 43 Ex</b>	50	1.969	0+4.0-23.0	0+0.157-0.906	65 x 40	2.559 x 1.575	0.4	0.882	<b>EXCRST010043046</b>
<b>C R S T 50 Ex</b>	63	2.480	0+8.0-30.0	0+0.315-1.181	78 x 40	3.071 x 1.575	0.7	1.433	<b>EXCRST010050046</b>

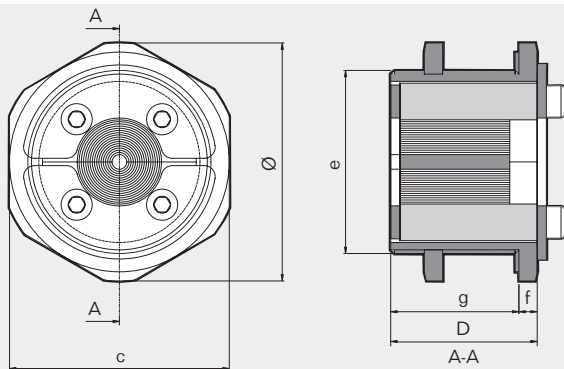

Note: All dimensions are nominal values  
Nota: tutte le dimensioni sono valori nominali  
Achtung: alle angegebenen Maße sind Nominalwerte  
Nota: Todas las dimensiones son valores nominales  
N.B. : toutes les dimensions sont nominales

	C R S T 25 Ex		C R S T 31 Ex		C R S T 43 Ex		C R S T 50 Ex Pos	
	(mm)	(in)	(mm)	(in)	(mm)	(in)	(mm)	(in)
c	36	1.4717	46	1.811	60	2.362	70	2.756
e	M 32 x 1.5	M 32 x 1.5	M40x1.5	M40x1.5	M50x1.5	M50x1.5	M63x1.5	M63x1.5
f	4	0.157	5	0.197	5	0.197	6	0.236
g	16	0.630	15	0.591	35	1.378	34	1.339
D	20	0.787	20	0.787	40	1.575	40	1.575

# Roxtec Wedge Ex



**GB** The Roxtec Wedge Ex is the compression unit for S, SF...W, and G Ex frames. The Roxtec Wedge Ex is a highly efficient compression unit which saves valuable installation time both when it comes to installation and re-installation of the Roxtec sealing system. This is made possible by the fact that the complete compression unit consists of only one piece, which, by turning the screws in the front, both compresses and decompresses.

**ES** El Roxtec wedge Ex es la unidad de compresión para la mayoría de marcos rectangulares Ex. El Roxtec wedge Ex es una unidad de compresión altamente eficaz que ahorra valioso tiempo de instalación tanto a la hora de instalar como de reinstalar el sistema de sellado Roxtec. Esto es posible ya que la unidad de compresión completa consiste en una única pieza que comprime y descomprime simplemente con girar los tornillos de su parte frontal.

**IT** Il Roxtec Wedge Ex è l'unità di compressione per i telai S, SF...W, G Ex. Il Roxtec Wedge è un efficiente sistema di compressione che permette di risparmiare tempo sia durante la prima installazione sia durante le successive riaperture del passaggio Roxtec, grazie al fatto che è un unico componente che si comprime e decomprime semplicemente agendo sulle viti poste sul suo lato frontale.

**FR** Le wedge Roxtec Ex est un système de compression destiné aux cadres Roxtec de la gamme standard. Le wedge Roxtec Ex est un système de compression très efficace qui permet notamment de gagner beaucoup de temps lors du montage-remontage grâce au fait qu'il est constitué d'une seule pièce que l'on serre et desserre en manipulant simplement des deux vis frontales.

**DE** Die Roxtec Keildichtung ist die Kompressionseinheit für fast alle Roxtec Ex Stahlrahmen. Die Roxtec Keildichtung ist eine äußerst effiziente Kompressionseinheit, die wertvolle Installationszeit sowohl beim Ein- als auch Ausbau des Roxtec Dichtungssystemeinspart. Dies wird dadurch ermöglicht, dass die gesamte Kompressionseinheit aus nur einem Teil besteht, der (durch anziehen/lösen der Schrauben an der Vorderseite) die Dichtpackung sowohl spannt als auch entspannt.

# Wedge kit/parts Ex, galvanised

Componenti del Wedge kit, galvanizzato ▶ Keildichtungskit/-teile Ex, feuerverzinkt  
 ▶ Wedgekit/componentes Ex, galvanizado ▶ Wedge kits Ex acier galvanisé



Wedge kit 120 Ex galv  
EXAWK0001201018



Wedge 120 Ex galv  
EXARW0001201018

IT	Wedge	Dimensioni esterne		Peso		Art. Nr.
		W (mm)	W (in)	(kg)	(lb)	
DE	Keildichtung	Außenmaße		Gewicht		Art.-Nr.
		W (mm)	W (in.)	(kg)	(lb)	
ES	Wedge	Dim. externas		Peso		Nº art.
		W (mm)	W (pulgadas)	(kg)	(libra)	
FR	Wedge	Dim. Extérieures		Poids		N° d'article
		W (mm)	W (pouces)	(kg)	(lb)	
GB	Wedge	External dimensions		Weight		Art. No.
		W (mm)	W (in)	(kg)	(lb)	
	<b>Wedge kit 120 Ex galv*</b>	(wedge) 120	(wedge) 4.724	1.5	3.307	<b>EXAWK0001201018</b>
	<b>Wedge 120 Ex galv</b>	120 4.	724	0.8	1.764	<b>EXARW0001201018</b>

\* The Wedge kit includes one Roxtec Wedge 120 Ex, five Stayplates, gauge tool, one wedge clip, one Lubricant and installation instructions.  
 Il wedge kit include un Roxtec wedge 120 Ex, cinque piastre d'ancoraggio, una wedge clip, un lubrificante e istruzioni di montaggio.  
 Das Keildichtungskit besteht aus einer Roxtec Keildichtung 120 Ex, fünf Ankerscheiben, einem Keildichtungsclip, einem Gleitmittelstift und einer Montageanleitung.

El Wedgekit incluye una unidad de compresión Roxtec wedge 120 Ex, cinco placas de separación (stayplates), un wedge clip, un lubricante e instrucciones de instalación.

Le kit wedge comprend 1 wedge Roxtec 120 Ex, 5 plaques de maintien, 1 wedge clip, 1 lubrifiant et des instructions de montage.

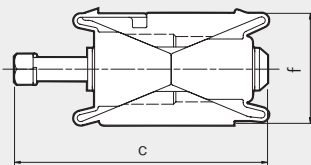

Compressed  
Compresso / Gespannt /  
Comprimido / Serré

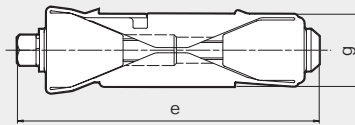

Uncompressed  
Decompresso / Entspannt /  
Descomprimido / Desserré

Pos	(mm)	(in)
c	109	4.291
e	130	5.118
f	48	1.890
g	29	1.142
k	SW 13	SW 0.512

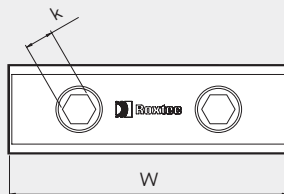

Wedge 120 Ex

Note: All dimensions are nominal values  
 Nota: tutte le dimensioni sono valori nominali  
 Achtung: alle angegebenen Maße sind Nominalwerte  
 Nota: Todas las dimensiones son valores nominales  
 N.B. : toutes les dimensions sont nominales

# Wedge kit/parts Ex, acid proof stainless steel

Componenti del wedge kit, in acciaio inox resistente agli acidi » Keildichtungskit/-teile Ex, säurefester, rostfreier Edelstahl » Wedgekit/componentes Ex, acero inoxidable a prueba de ácidos » Wedge kits Ex /composants acier inox résistants aux acides



Wedge kit 120 Ex AISI 316  
EXAWK0001201021



Wedge Ex AISI 316  
EXARW0001201021

IT	Wedge	Dimensioni esterne		Peso		Art. Nr.
		W (mm)	W (in)	(kg)	(lb)	
DE	Keildichtung	Außenmaße		Gewicht		Art.-Nr.
		W (mm)	W (in.)	(kg)	(lb)	
ES	Wedge	Dim. externas		Peso		Nº art.
		W (mm)	W (pulgadas)	(kg)	(libra)	
FR	Wedge	Dim. Extérieures		Poids		N° d'article
		W (mm)	W (pouces)	(kg)	(lb)	
GB	Wedge	External dimensions		Weight		Art. No.
		W (mm)	W (in)	(kg)	(lb)	
	<b>Wedge kit 120 Ex AISI 316*</b>	(wedge) 120	(wedge) 4.724	1.5	3.307	<b>EXAWK0001201021</b>
	<b>Wedge 120 Ex AISI 316</b>	120	4.724	0.8	1.764	<b>EXARW0001201021</b>

\* The Wedge kit includes one Roxtec Wedge 120 Ex, five Stayplates, gauge tool, one Wedge Clip, one Lubricant and installation instructions.

Il wedge kit include un Roxtec wedge 120 Ex, cinque piastre d'ancoraggio, una Wedge Clip, un lubrificante e istruzioni di montaggio.

Das Keildichtungskit besteht aus einer Roxtec Keildichtung 120 Ex, fünf Ankerscheiben, einem Keildichtungsclip, einem Gleitmittelstift und einer Montageanleitung.

El Wedgekit incluye una unidad de compresión Roxtec wedge 120 Ex, cinco placas de separación (stayplates), un Wedge Clip, un lubricante e instrucciones de instalación.

Le kit wedge comprend 1 wedge Roxtec 120 Ex, 5 plaques de maintien, 1 wedge clip, 1 lubrifiant et des instructions de montage.

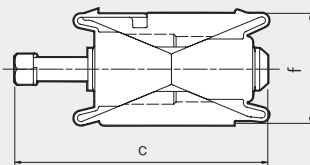

Compressed  
Compresso / Gespannt /  
Comprimido / Serré

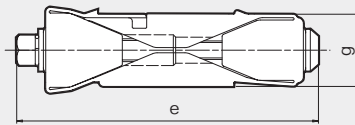

Uncompressed  
Decompresso / Entspannt /  
Descomprimido / Desserré

Pos	(mm)	(in)
c	109	4.291
e	130	5.118
f	48	1.890
g	29	1.142
k	SW 13	SW 0.512

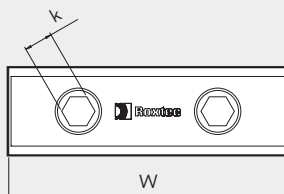

Wedge 120 Ex

Note: All dimensions are nominal values  
Nota: tutte le dimensioni sono valori nominali  
Achtung: alle angegebenen Maße sind Nominalwerte  
Nota: Todas las dimensiones son valores nominales  
N.B. : toutes les dimensions sont nominales

# Roxtec Stayplate Ex



**GB** Roxtec Stayplates Ex are used for pull-out resistance against forces in cables. To be inserted between rows of modules in frames with a rectangular packing space and no built-in compression.

- For use with Group RM frames and components

**ES** Las placas de separación de Roxtec se usan en aberturas de marcos rectangulares entre hileras de módulos para conseguir una resistencia de tracción.

- Uso con componentes y marcos del grupo RM

**IT** Le piastre di ancoraggio di Roxtec sono utilizzate nelle aperture di telai rettangolari, tra le file di moduli, per evitare lo spostamento longitudinale degli stessi moduli.

- Da utilizzare con componenti del gruppo RM

**FR** Les plaques de maintien Roxtec sont utilisées dans des ouvertures de cadres rectangulaires entre des rangées de modules pour une résistance à la traction.

- Pour composants du Groupe RM

**DE** Roxtec Ankerplatten werden in Rahmen mit rechteckigem Innenprofil ohne integrierte Kompressionseinheit zwischen Modulreihen montiert, um diese gegen Herausziehen zu sichern.

- Zur Verwendung mit Komponenten der Gruppe RM

# Stayplate Ex

Piastra di ancoraggio Ex » Ankerscheibe Ex » Placa de separación Ex » Plaque de maintien Ex



**Stayplate 120 Ex galv**  
EXASP001200018

**Stayplate 120 Ex AISI 316**  
EXASP001200021

IT	Piastra d'ancoraggio	Spazio di montaggio		Peso		Art. Nr.
		W (mm)	W (in)	(kg)	(lb)	
DE	Ankerscheibe	Für Belegraumgröße		Gewicht		Art.-Nr.
		W (mm)	W (in.)	(kg)	(lb)	
ES	Placa de separación	Medida apropiada del hueco de sellado		Peso		Nº art.
		W (mm)	W (pulgadas)	(kg)	(libra)	
FR	Plaque de maintien	Pour espace de remplissage		Poids		N° d'article
		W (mm)	W (pouces)	(kg)	(lb)	
GB	Stayplate	Fits packing space		Weight		Art. No.
		W (mm)	W (in)	(kg)	(lb)	
	<b>Stayplate 120 Ex galv</b>	120	4.724	0.1	0.243	<b>EXASP001200018</b>
	<b>Stayplate 120 Ex AISI 316</b>	120	4.724	0.1	0.243	<b>EXASP001200021</b>

**galv** Galvanised  
Galvanizzato  
Feuerverzinkt  
Galvanizado  
Acier galvanisé

**AISI 316** Acid proof stainless steel  
Acciaio inox resistente agli acidi  
Säurefester, rostfreier Edelstahl  
Acero inoxidable a prueba de ácidos  
Acier inox résistant aux acides

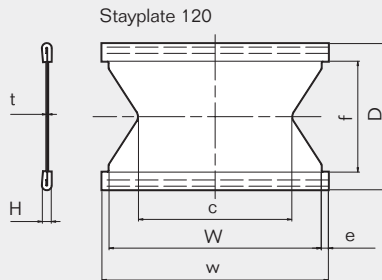

Pos	(mm)	(in)
t	0.5	0.020
c	86	3.386
e	4	0.157
f	62	2.499
D	82	3.228
H	5	0.197
W	119	4.685
w	127	5.000

Note: All dimensions are nominal values  
Nota: tutte le dimensioni sono valori nominali  
Achtung: alle angegebenen Maße sind Nominalwerte  
Nota: Todas las dimensiones son valores nominales  
N.B. : toutes les dimensions sont nominales



# Lubricant

Lubrificante » Gleitmittel » Lubricante » Lubrifiant



Lubricant 10 ml  
ALT0000001000

Lubricant 25 ml  
ALT0000003000



Natural tallow is used to lubricate the sealing modules, Roxtec Wedge and the inside of the frame. This provides even compression and a secure seal.

Il lubrificante in sego naturale è usato per lubrificare i moduli di sigillatura, il Roxtec Wedge e l'interno del telaio. Questo garantisce, insieme alla compressione, una sicura sigillatura.

Zum Einfetten der Module, der Roxtec Keildichtung sowie der Innenflächen des Rahmens wird Naturtalg verwendet. Es gewährleistet eine gleichmäßige Druckverteilung im Schott und eine sichere Abdichtung.

Para lograr una compresión uniforme y un sello firme, se emplea sebo natural para lubricar los módulos de sellado, el Roxtec wedge y el interior del marco.

La graisse naturelle utilisée pour lubrifier les modules, le système de compression Roxtec wedge et l'intérieur du cadre assurent une compression homogène et une traversée sûre.

# Roxtec wedge clip

Clip per cuneo Roxtec » Roxtec-Keildichtungsclip » Clip para unidad de compresión de Roxtec » Le clip du coin Roxtec



Roxtec Wedge clip

The Roxtec wedge clip is delivered with the Roxtec wedge. Attach the wedge clip to the wedge bolts to check that the wedge has been properly tightened.

La clip per cuneo Roxtec viene fornita con il cuneo Roxtec. E' utilizzata per verificare, dopo l'installazione, che il cuneo sia stato serrato correttamente.

Der Roxtec-Keildichtungsclip wird mit der Roxtec-Keildichtung geliefert. Clip an den Schrauben anbringen um zu überprüfen, ob die Keildichtung ordnungsgemäß gespannt wurde.

El clip para la unidad de compresión de Roxtec se suministra con la unidad de compresión de Roxtec. Sujetar el clip de la unidad de compresión a los pernos para asegurar que la unidad de compresión queda correctamente apretada.

Le clip du coin Roxtec est fourni avec le coin Roxtec. Fixez le clip aux boulons du coin pour vous assurer que le ce dernier a été correctement serré.

# Assembly / Disassembly Tools

Utensili per il montaggio e lo smontaggio » Montage-/Demontage-Werkzeuge » Herramientas de montaje/desmontaje » Outils pour montage/démontage



**Pre Compression Tool, small**  
5ICT000001269



**Pre Compression Tool, large**  
ICT0001000000

The Pre Compression tools, small and large, help compressing installed modules and stayplates to make more room for the Roxtec Wedge. During installation they also help keeping the items in place.

Gli utensili di precompressione, piccoli e grandi, aiutano, comprimendo i moduli e le piastre di ancoraggio installate, a creare più spazio per il Roxtec Wedge. Durante l'installazione questi utensili aiutano a mantenere i vari componenti in posizione.

Die kleinen sowie großen Vorpress-Hilfen erleichtern den Einbau der Roxtec Keildichtung. Mit Ihrer Hilfe werden die eingesetzten Module und Ankerscheiben vorgepresst um Raum für die Keildichtung zu schaffen. Sie helfen auch während der Montage die Packung zu halten und damit die Montage zu erleichtern.

Las herramientas de pre-compresión, pequeña y grande, ayudan en la instalación comprimiendo los módulos y placas de separación para lograr más espacio para el Roxtec Wedge. También mantienen los artículos en su sitio.

Les outils de pré-compression aident à comprimer les modules et les plaques de maintien afin de libérer suffisamment d'espace pour insérer le Roxtec wedge. Durant le montage, ils aident également à maintenir les différents éléments en place.



**Pre-compression eccentric tool, large**  
ICT0001000301

**Pre-compression eccentric tool, small**  
ICT0001000302

**Pre-compression eccentric tool, compact**  
ICT0001000316

The different types of pre-compression tools facilitate installations by compressing rows of modules and stayplates to make more room for the Roxtec Wedge during installation.

Le differenti tipologie degli utensili di precompressione facilitano le installazioni, comprimendo le file di moduli e le piastre di ancoraggio, per creare più spazio al Roxtec Wedge durante l'installazione.

Die verschiedenen Vorpress-Hilfen erleichtern die Montage, indem sie Modulreihen und Ankerscheiben vordrücken und dadurch mehr Raum für die Keildichtung schaffen.

Los diferentes tipos de herramientas de pre-compresión facilitan la instalación al comprimir las filas de módulos y placas de separación para que el Roxtec Wedge tenga más espacio durante el montaje.

Les différents outils de pré-compression aident à comprimer les modules et les plaques de maintien afin de libérer suffisamment d'espace pour insérer le Roxtec wedge durant la phase de montage



**Pre-compression wedge 60/40**  
5ICT000003691



**Pre-compression wedge 120**  
ICT0001000500



**Handgrip pre-comp**  
ICT0001000401

## Assembly / Disassembly Tools

Utensili per il montaggio e lo smontaggio » Montage-/Demontage-Werkzeuge » Herramientas de montaje/desmontaje » Outils pour montage/démontage



Stayplate clamps horizontal inst, 2 pcs  
ICT0001000100

Stayplate clamps for horizontal installations. To be used with stayplates, minimum width 120 mm, 4.724".

Pinze per piastre di ancoraggio per installazioni orizzontali. Da utilizzare con piastre di ancoraggio da 120 mm

Ankerscheiben-Klemmen für waagerechte Montagen. Einsatz nur in Verbindung mit Roxtec Ankerscheiben für 120 mm (4.724") Fensterbreite.

Abrazaderas para las placas de separación (clamp) para instalaciones horizontales. Para su uso con placas de separación RM, mínimo de 120mm, 4.724".

Pinces pour maintenir les plaques de maintien lors de montages à l'horizontal. A utiliser avec des plaques de maintien de largeur minimum 120mm.



Stayplate clip  
ICT0001000200

Stayplate clip for use with RM stayplates, minimum width 120 mm, 4.724".

Clip per piastre di ancoraggio da 120 mm.

Ankerscheiben-Clip für Roxtec Ankerscheiben für 120 mm Fensterbreite.

Clip para la placa de separación para su uso con placas de separación RM, mínimo de 120mm, 4.724".

Pince pour maintenir les plaques de maintien lors de montages à l'horizontal. A utiliser avec des plaques de maintien 120mm.

## Slide Caliper



Slide Caliper  
IQR0001000000

A handy tool for easy selection of proper module size and its adaptation. Shows cable OD, corresponding module and approximately how many layers to peel in each module half.

Un maneggevole utensile per scegliere facilmente le esatte grandezze dei moduli. Mostra il diametro del cavo, i corrispondenti moduli e approssimativamente quanti strati devono essere rimossi in ogni metà del modulo.

Eine Anpasshilfe zur leichten Ermittlung der richtigen Modulgröße und deren Anpassung an die durchzuführende Leitung. Mit ihrer Hilfe wird der Leitungsaußendurchmesser gemessen, das passende Modul sowie die Anzahl abzunehmender Pellen ermittelt.

Una herramienta práctica para seleccionar fácilmente el tamaño adecuado de módulo y adaptarlo al cable. Muestra el diámetro externo del cable, que se corresponde con el módulo y al número de capas aproximadas que hay que quitar de cada mitad de módulo.

Outil manuel permettant de choisir le module approprié au diamètre d'un câble. Donne le diamètre du câble et le nombre approximatif de couches à retirer sur chaque moitié de module.

# Installation instructions

Istruzioni di montaggio » Montage-Vorschriften » Instrucciones de montaje » Instructions de montage

**GB** All our products come with an installation instruction. These are also available at [www.roxtec.com](http://www.roxtec.com).

**DE** Bei jedem unserer Produkte liefern wir die Montage-Vorschriften mit. Sie können diese auch auf unserer Internetseite [www.roxtec.com](http://www.roxtec.com) abrufen.

**FR** Tous nos produits sont fournis avec des instructions de montage. Elles sont également disponibles sur le site [www.roxtec.com](http://www.roxtec.com).

**IT** Tutti i nostri prodotti vengono forniti con le istruzioni di montaggio. Queste istruzioni sono anche disponibili su [www.roxtec.com](http://www.roxtec.com).

**ES** Todos nuestros productos incluyen instrucciones de montaje, también disponibles en [www.roxtec.com](http://www.roxtec.com).

## EX frame installation

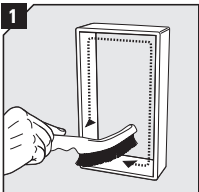

Remove any dirt inside the frame.

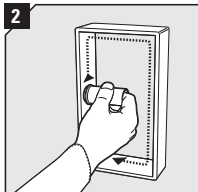

Lubricate the inside faces of the frame. Make sure to get lubricant into the corner.

## Installation of the modules

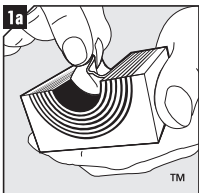

Adapt modules which are to hold cables or pipes by peeling layers until you reach the gap seen in pic. 1b.

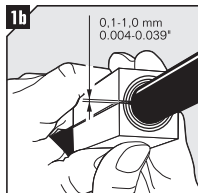

Achieve a 0.1-1.0 mm gap between the two halves when held against the cable/pipe. Use the Ex Gap Gauge.

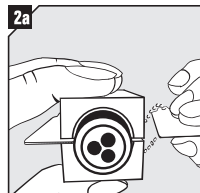

Measure the gap with the Ex Gap Gauge by holding blade one in one gap and checking the other with blade two.

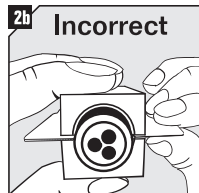

If the gap is too big, the Gauge will slip in easily.

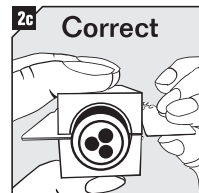

If the gap is correct, there will be no room for blade two.

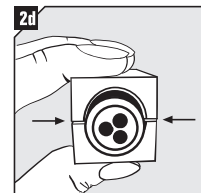

When checking without the Gauge, there shall be a visual gap.

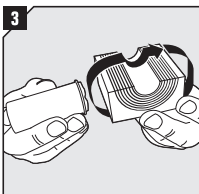

Lubricate all modules for the frame thoroughly, both the inside and the outside surfaces.

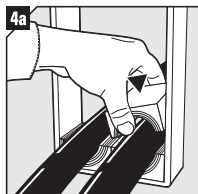

Insert the modules according to your installation plan (transit plan). Usually start with the largest modules.

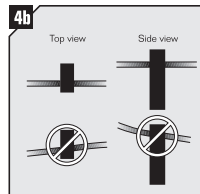

Note that cables shall go straight through the frame.

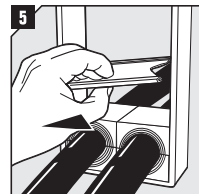

Insert a stayplate on top of every finished row of modules.

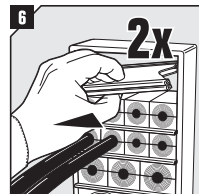

Before inserting the final row of modules, insert two stayplates.

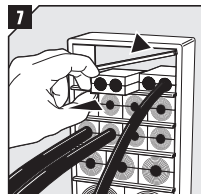

Separate the two stayplates and insert the final row of modules between the stayplates.

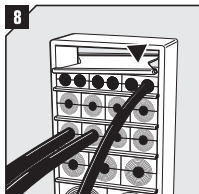

Drop the upper stayplate on top of the modules.

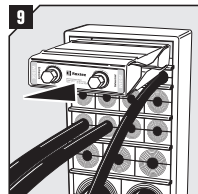

Lubricate and insert the wedge on top of the frame (standard position).

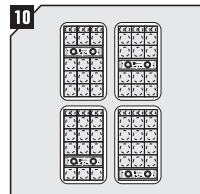

The Roxtec Wedge Ex can be placed anywhere in the frame.

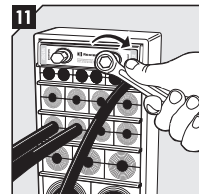

Tighten the screws until full stop, approx 20 Nm (15 ft.lb.).

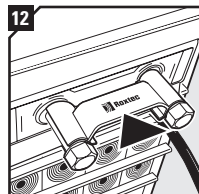

Attach the Wedge Clip to the wedge bolts to check that the wedge has been properly tightened.

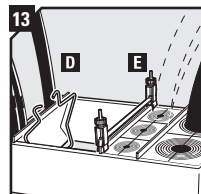

Stayplate Clips (D) and Stayplate Clamps (E) can be used to simplify horizontal assembly.

# Guideline for selling Roxtec Explosion protected seals

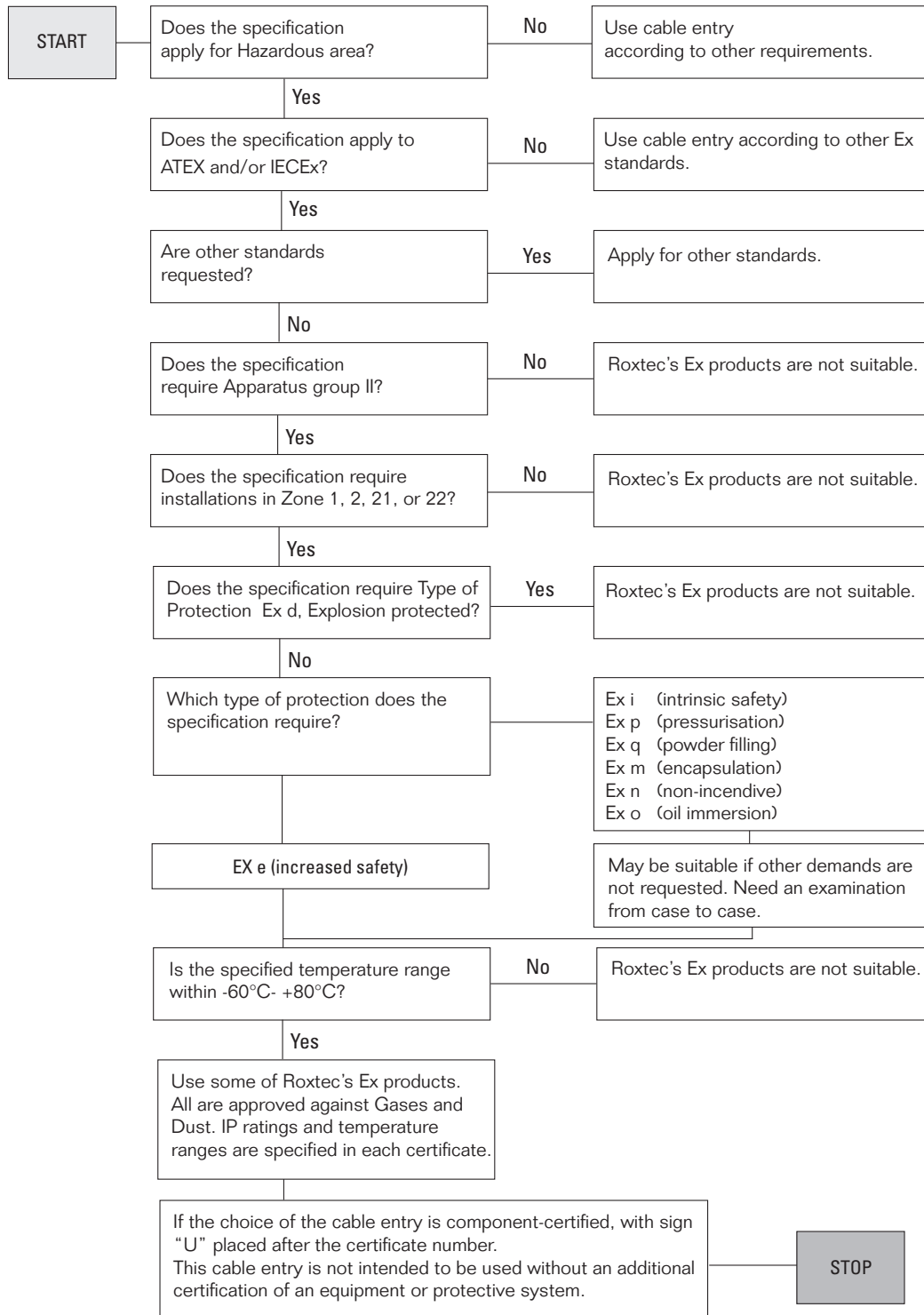



## DISCLAIMER

"The Roxtec cable entry sealing system ("the Roxtec system") is a modular-based system of sealing products consisting of different components. Each and every one of the components are necessary for the best performance of the Roxtec system. The Roxtec system has been certified to resist a number of different hazards. Any such certification, and the ability of the Roxtec system to resist such hazards, is dependent on all components that are installed as a part of the Roxtec system. Thus, the certification is not valid and does not apply unless all components installed as part of the Roxtec system are manufactured by or under license from Roxtec ("authorized manufacturer"). Roxtec gives no performance guarantee with respect to the Roxtec system, unless (I) all components installed as part of the Roxtec system are manufactured by an authorized manufacturer and (II) the purchaser is in compliance with (a), and (b), below.

(a) During storage, the Roxtec system or part thereof, shall be kept indoors in its original packaging at a temperature not exceeding +70°C/+158°F and not below -40°C/-40°F.

(b) Installation shall be carried out in accordance with Roxtec installations instructions in effect from time to time.

The product information provided by Roxtec does not release the purchaser of the Roxtec system, or part thereof, from the obligation to independently determine the suitability of the products for the intended process, installation and/or use.

Roxtec gives no guarantee for the Roxtec system or any part thereof and assumes no liability for any loss or damage whatsoever, whether direct, indirect, consequential, loss of profit or otherwise, occurred or caused by the Roxtec systems or installations containing components not manufactured by an authorized manufacturer.

Roxtec expressly excludes any implied warranties of merchantability and fitness for a particular purpose and all other express or implied representations and warranties provided by statute or common law. User determines suitability of the Roxtec system for intended use and assumes all risk and liability in connection therewith. In no event shall Roxtec be liable for consequential, punitive, special, exemplary or incidental damages."

Roxtec ® and Multidiameter ® are registered trademarks of Roxtec in Sweden and/or other countries.

Roxtec ® is a registered trademark of Roxtec in Sweden and/or other countries.  
Multidiameter ® is a registered trademark of Roxtec in Sweden and/or other countries.

Roxtec system, a number of products used for cable entries

© Roxtec International AB 2008 Photo/illustration: Roxtec AB, Production: Roxtec Market Communications



**WWW.CABLEJOINTS.CO.UK**  
**THORNE & DERRICK UK**  
**TEL 0044 191 490 1547 FAX 0044 477 5371**  
**TEL 0044 117 977 4647 FAX 0044 977 5582**  
**WWW.THORNEANDDERRICK.CO.UK**

