



ELECTRICAL INDUSTRIES



WWW.CABLEJOINTS.CO.UK
THORNE & DERRICK UK
TEL 0044 191 490 1547 FAX 0044 477 5371
TEL 0044 117 977 4647 FAX 0044 977 5582
WWW.THORNEANDDERRICK.CO.UK



2011 2012
general catalogue

FPB Palazzoli

REEFER CONTAINER



REEFER CONTAINER

CONTAINER PRODUCTS

Conformity to Standards:	BS EN 60309-1	IEC 60309-1	Temperature resistance:	Operating	-25 to +50°C
	BS EN 60309-2	IEC 60309-2		Storage	-30 to +70°C
	BS EN 60529	IEC 60529	Cable entry	(Plugs & Connectors) 32A 3P+E	min: 12.5 max: 19.5mm
	EN 60947-3		(Sw. Interlock Skt) 32A 3P+E		M25 Threaded
Impact resistance:	>IK 06		Connecting sections of the wires	32A (Plugs & Connectors)	min: 2.5 max: 6 mm ²
Glow wire test:	850°C			32A Sockets	min: 2.5 max: 10 mm ²

Reefer container

A complete range of watertight (IP67) Plugs & Sockets designed for Container use. Units are in accordance with IEC60309-2, & are rated at 32A.

- A heavy duty product range comprising plugs, connectors, sockets, & switched / mechanically interlocked sockets
- Exclusively designed for reefer container applications
- 32 Amp >380V 50Hz – 440V 60Hz 3 pole + earth (4 pin) rating only
- 3P + Earth with the earth contact in the 3 hour earth clocking position

PLUGS AND CONNECTORS

IP67 Watertight - Cee plug



A	V	
32	>380-400	PM32/605RCFPB

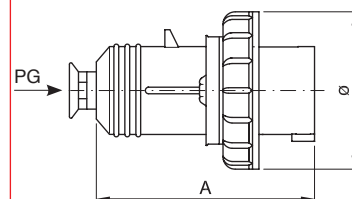

Rated current (A)	Poles	A (mm)	ø (mm)
32	2P+E	141	94
	3P+E	141	94
	3P+N+E	141	101

IP67 Watertight - Cee connector



A	V	
32	>380-400	473486

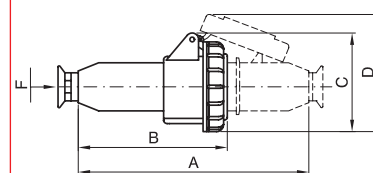

Rated current (A)	Poles	A (mm)	B (mm)	C (mm)	D (mm)
32	2P+E				
	3P+E	328	153	105	125
	3P+N+E			110	130

REEFER CONTAINER

SURFACE, PANEL SOCKETS AND INLETS

IP67 Watertight surface socket



A	V	
32	>380-400	PM32/645/RCPFB

- Smooth walls undrilled
- Cable entry possible on all 4 faces plus rear
- Generous wiring space

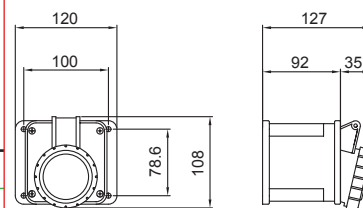

IP67 Watertight topTER panel socket - angled



A	V	
32	>380-400	489223

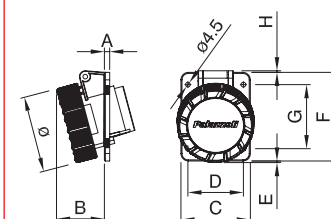

(A)	Poles	mm.						
		A	B	C	D	F	G	ø
16	2P+E	5	45	65	52	60	72	5
	3P+E	5	46	65	52	60	72	80
	3P+N+E	7	47	88	77	100	85	88
32	2P+E	7	54	88	77	100	85	93
	3P+E	7	54	88	77	100	85	93
	3P+N+E	7	55	88	77	100	85	100

IP67 Watertight - Cee appliance inlet



A	V	
32	>380-400	476486

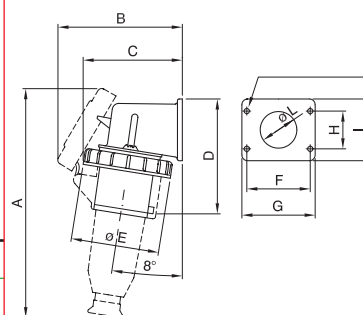

(A)	Poles	mm.									
		A	B	C	D	E	F	G	H	L	
32	3P+E	248	136	108	125	94	68	80	40	66	40

REEFER CONTAINER

SWITCHED AND INTERLOCKED SOCKETS

IP67 Watertight - switched and interlocked socket



A	V	
32	>380-400	PM32/3405RC

Can be padlocked in on & off positions

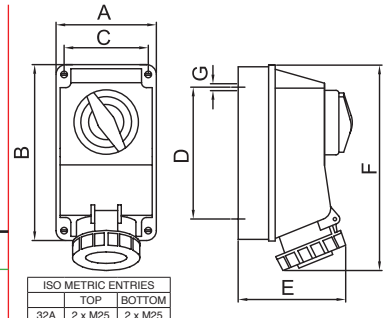

ISO METRIC ENTRIES	
TOP	BOTTOM
32A	2 x M25 2 x M25

(A)	Poles	mm.					
		A	B	C	D	E	F
32	3P+E	122	212	101	171	150	232
							6.5

IP66/67 Watertight - topTER switched interlocked socket



A	V	
32	>380-400	579710

Can be padlocked in on & off positions

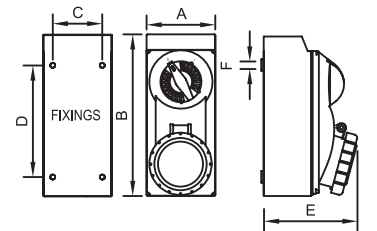

(A)	mm.					
	A	B	C	D	E	F
32	108	260	76	170	148	5

IP67 Watertight - switched and interlocked socket with RCD



A	V	
32	>380-400	PMRCD32/405/SI/RC

Protection at 30mA sensitivity

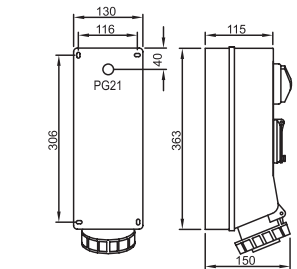

IP67 Watertight - Tais switched and interlocked socket with MCB



A	V	
32	>380-400	474771

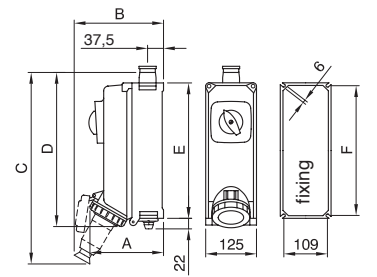

(A)	Poles	mm.					
		A	B	C	D	E	F
32	3P+E	177	213	458	377	335	319

IP67 Watertight - Tais switched and interlocked socket with 4 modules window



A	V	
32	>380-400	472133

- Window allows customer to install their own protective device
- Flying leads from socket & isolation switch to allow ease of installation for protective device

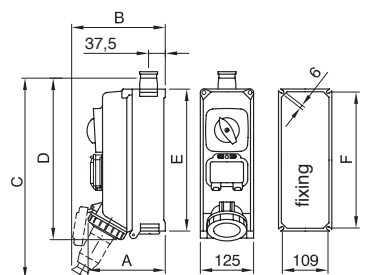

(A)	Poles	mm.					
		A	B	C	D	E	F
32	3P+E	177	213	458	377	335	319



Dealer's stamp



WWW.CABLEJOINTS.CO.UK
THORNE & DERRICK UK
 TEL 0044 191 490 1547 FAX 0044 477 5371
 TEL 0044 117 977 4647 FAX 0044 977 5582
 WWW.THORNEANDDERRICK.CO.UK