

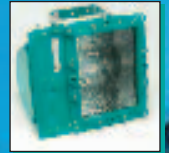

**Petrel** 

**Hazardous Area Equipment**

Hazardous area lighting  
and control equipment

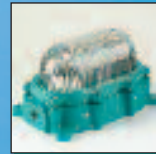

Tel: +44 (0)191 490 1547

Fax: +44 (0)191 477 5371

Email: [northernsales@thorneandderrick.co.uk](mailto:northernsales@thorneandderrick.co.uk)

Website: [www.cablejoints.co.uk](http://www.cablejoints.co.uk)

[www.thorneandderrick.co.uk](http://www.thorneandderrick.co.uk)

Welcome to Petrel, the UK based hazardous area company within the Chamberlin plc group.

Our aim is a simple one—to provide safe, reliable quality products, designed for the rigours of hazardous area applications, be that an offshore environment or a simple workshop inspection pit. At the forefront of our design philosophy is how to make it easy for the customer to use Petrel products. You will notice amongst our products innovative design ideas to overcome real world situations both in ongoing routine maintenance and installation.

The information contained within this catalogue will allow you to understand the concepts behind ATEX and IECEx legislation, and once this has been applied to you or your customers site, there is a range of products for you to select from. At all times our sales partners and distributors have access to the latest product information throughout the world, as we continue to grow the Petrel brand globally.

Should you at any point require further information, please feel free to call your nearest sales/distribution contact, or of course call us directly for friendly help and guidance. Our main contact numbers are shown below and our sales partners details can be found on our website.

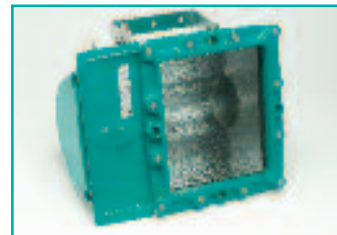
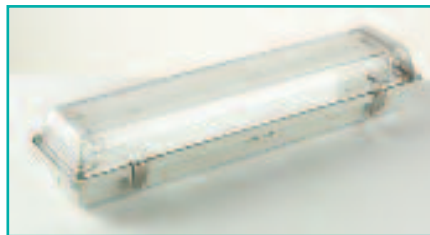

Petrel Limited, 22 Fortnum Close, Kitts Green, Birmingham, B33 0LB United Kingdom  
T +44 (0)121 783 7161 • F +44 (0)121 783 5717 • E [sales@petrel-ex.co.uk](mailto:sales@petrel-ex.co.uk)

## Contents

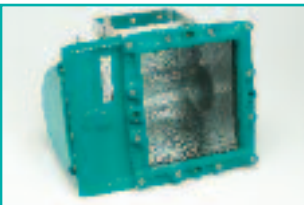

Introduction	page 1
Hazardous Area Guide	page 3
Zone 1 Lighting	page 7
Zone 2 Lighting	page 24
Zone 1 Ex d Enclosures	page 33
Industrial Lighting	page 36
Technical & Spares	page 43
Case Studies	page 48

**Petrel Limited**  
22 Fortnum Close,  
Kitts Green,  
Birmingham B33 0LB  
United Kingdom

T +44 (0)121 783 7161  
F +44 (0)121 783 5717  
E [sales@petrel-ex.co.uk](mailto:sales@petrel-ex.co.uk)  
[www.petrel-ex.co.uk](http://www.petrel-ex.co.uk)



**Petrel Guide to Hazardous Areas**

**Atex directive**

The Atex Directive is a mandatory requirement for all hazardous area equipment sold in the European Union and must have applicable Atex certificates. Certain other countries accept the IECEx standard, which is derived from similar principles.

In addition to the technical requirements demanded by the appropriate standards for each type of protection concept, the Atex Directive imposes additional requirements on the certificate holder in terms of quality system, product documentation, installation information, possible limitations of use in the relation to its intended environment, labelling information etc.

Zone	Equipment
Zone 0 & 20	Category 1
Zone 1 & 21	Category 2
Zone 2 & 22	Category 3

The marking of the equipment shall include the following typical data:

- Ex II 2 G, Ex II 3 D** Where II is the gas group; 2 is the category for use( previously known as zone, and still widely used—see table above for equivalence) G (or D) is the type of explosive atmosphere - G = gas, vapour or mist; and D = Dust
- IIC T4 Ta = -20°C to + 55°C** IIC refers to the gas group, and where the T class will vary against ambient
- IIC T5 Ta = -20°C to + 25°C** The T class marking for dust may also be shown if different to gas



**Ingress protection**

In addition to protection against the risk of explosion or ignition, luminaires for use in hazardous areas will also need to provide adequate protection against the ingress of solids or liquids. The degree of classification is denoted by the IP classification system.

A two digit number is used to identify the degree of protection.

The first digit of the code denotes protection against dust and solid objects

The second digit denotes protection against moisture

**INGRESS PROTECTION (IP) CODE BS EN 60529 (IEC 60529)**

IP0X	No special protection	IPX0	No special protection
IP1X	Objects ≥50mm diameter (e.g. part of a hand)	IPX1	Vertically dripping water
IP2X	Objects ≥12.5mm diameter (e.g. finger)	IPX2	Vertically dripping water when enclosure tilted by 15°
IP3X	Objects ≥2.5mm diameter (e.g. tool)	IPX3	Sprayed water up to 600mm from vertical
IP4X	Objects ≥1.00mm diameter (e.g. wire)	IPX4	Sprayed water from all directions
IP5X	Dust protection	IPX5	Water jets
IP6X	Dust tight	IPX6	Powerful water jets
		IPX7	Temporary submersion to a depth of 1m (for half an hour)
		IPX8	Extended submersion to a depth ≥1m

**Petrel Guide to Hazardous Areas**

**Temperature classification**

The temperature classification of a given gas is the temperature above which an appropriate mixture of that gas with air will ignite. It is critical that the maximum surface temperature of any part of the equipment which may come into contact with the gas/air mixture, does not exceed the ignition temperature of the mixture.

The temperature class or 'T rating' is normally based on an ambient temperature of -20°C to +40°C

Class T Rating	Surface Temperature °C Max permitted	Ignition Temperature °C Gas/Air mixture
T1	450	>450
T2	300	>300
T3	200	>200
T4	135	>135
T5	100	>100
T6	85	>85

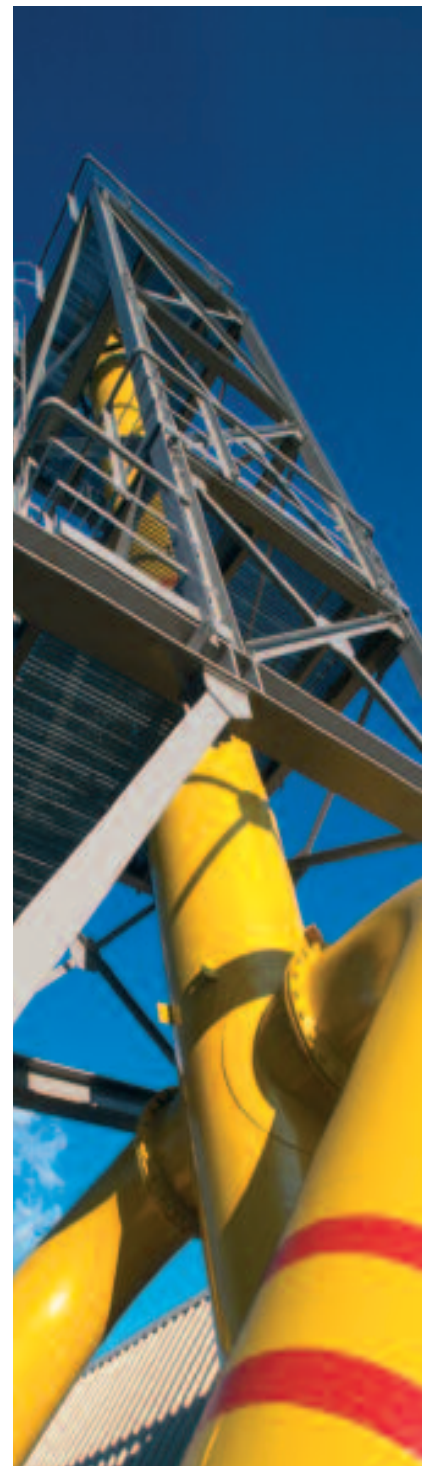

**Categories and Zone definitions for gas and dust**

- Gas**
- Zone 0** A place in which an explosive atmosphere consisting of a mixture with air of dangerous substances in the form of gas, vapour or mist is present continuously or for long periods or frequently
  - Zone 1** A place in which an explosive atmosphere consisting of a mixture with air of dangerous substances in the form of gas, vapour or mist is likely to occur in normal operation occasionally.
  - Zone 2** A place in which an explosive atmosphere consisting of a mixture with air of dangerous substances in the form of gas, vapour or mist is not likely to occur in normal operation but, if it does occur, will persist for a short period only.

- Dust**
- Zone 20** A place in which an explosive atmosphere in the form of a cloud of combustible dust in air is present continuously, or for long periods or frequently.
  - Zone 21** A place in which an explosive atmosphere in the form of a cloud of combustible dust in air is likely to occur in normal operation occasionally.
  - Zone 22** A place in which an explosive atmosphere in the form of a cloud of combustible dust in air is not likely to occur in normal operation but, if it does occur, will persist for a short period only.

The hazardous area zone classification and corresponding equipment categories are:

- Zone 0 or Zone 20 - category 1 equipment
- Zone 1 or Zone 21 - category 2 equipment
- Zone 2 or Zone 22 - category 3 equipment

Category 1 equipment can also be used in zones 1 and 21 and category 1 and 2 equipment can be used in zones 2 and 22.

**Petrel Guide to Hazardous Areas**

**Gas Groups**

The explosive gases, vapours, and mists present in the atmosphere are grouped into temperature classes and gas groups according to various properties such as ignition temperature, the energy required to ignite the mixture, the energy produced by an explosion, flame transmission capability etc.

- Group I Electrical equipment for use underground in mines susceptible to the hazard of firedamp (methane)
- Group II Electrical equipment for use in all other hazardous areas. This group is then subdivided into 3 further groups (IIA, IIB and IIC) according to the maximum experimental safety gap for non-transmission of an internal ignition plus the minimum ignition current of the mixture.

Gas Group	Temperature Class					
	T1	T2	T3	T4	T5	T6
I	Methane					
II A	Acetone	Ethanol	Benzene	Acetaldehyde		
	Ethane	i-Amyl acetate	Diesel fuel	Ethyl ether		
	Ethyl ethanoate	n-Butane	Aircraft fuel			
	Ammonia	n-Butyl alcohol	Heating oils			
	Benzol (pure)		n-Hexane			
	Ethanoic acid					
	Carbon oxide					
	Methane					
	Methanol					
	Propane					
Toluene						
II B	Coal gas	Ethylene				
II C	Hydrogen	Acetylene				Carbon disulphide

Any electrical equipment certified for use in Group II is suitable for use in all Group II categories, IIA, IIB and IIC. Equipment certified for Group IIC is also suitable for IIB and IIA, whilst equipment certified for IIB can also be used in IIA. Group IIA certified equipment can only be used on Group IIA applications.

**Dust Groups**

The explosive nature of dusts is generally classified into three groups.

Dust Group	Description	Example
IIIA	Combustible Flyings	Material, fibres and flyings produced by machinery found in industries such as textile, cotton and wood cutting which settles around equipment and is vulnerable to ignition from heat or sparks.
IIIB	Non-conductive dust	Dust with electrical resistivity greater than 10K ohm.m
IIIC	Conductive dust	Metal particles such as Aluminium or Titanium that are deposited on equipment as dust layers and form as dust clouds in the local atmosphere

## Petrel Guide to Hazardous Areas

### Protection Concepts

There are established engineering concepts recognised by the IEC for the design of electrical equipment for hazardous area applications. These engineering concepts are the basis of protection against the risk of fire or explosion from gas or dust. Each concept is identified by a protection symbol. If a design relies on more than one concept all symbols are normally shown.

### Gas Protection Concepts

Symbol & EN ref	Concept	Summary	Zone use	Category
Ex ia EN/ EC 60079-11	Intrinsic safety	Limits energy of sparks & surface temperatures (using electronics c/w 2 failure protection devices)	0,1 & 2	0, 1 & 2
Ex ib EN/ EC 60079-11	Intrinsic safety	Limits energy of sparks & surface temperatures (using electronics c/w 1 failure protection devices)	1 & 2	2 & 3
Ex d EN/ EC 60079-1	Flameproof	Contains explosion quenches flame	1 & 2	2 & 3
Ex e EN/ EC 60079-7	Increased safety	No arcs, sparks or hot surfaces	1 & 2	2 & 3
Ex p EN/ EC 60079-2	Pressurised	Keeps flammable gas out	1 & 2	2 & 3
Ex m EN/ EC 60079-18	Encapsulated	Keeps flammable gas out	1 & 2	2 & 3
Ex q EN/ EC 60079-5	Powder filled	Keeps flammable gas out	1 & 2	2 & 3
Ex o EN/ EC 60079-6	Oil filled	Keeps hazard away from ignition source using inert oil	1 & 2	2 & 3
Ex nA EN/ EC 60079-15	Non-sparking	No arcs, sparks or hot surfaces	2	3
Ex nR EN/ EC 60079-15	Restricted breathing	Gasket restricts air movement	2	3
Ex nP EN/ EC 60079-15	Pressurization	Over pressure prevents air ingress	2	3
Ex nL EN/ EC 60079-15	Energy limiting	Insufficient power to cause explosion	2	3
Ex nC EN/ EC 60079-15	Sealed device/ Enclosed break/ hermetically sealed/ encapsulated	Sealed from air ingress	2	3

### Dust Protection Concepts

Symbol & EN ref	Concept	Zone use	Category
Ex tDA20 EN/ EC 61241-1	Protection by enclosure	20, 21 & 22	1, 2 & 3
Ex tDB20 EN/ EC 61241-1	Protection by enclosure	20, 21 & 22	1, 2 & 3
Ex iaD EN/ EC 61241-11	Intrinsic safety	20, 21 & 22	1, 2 & 3
Ex maD EN/ EC 61241-18	Encapsulation	20, 21 & 22	1, 2 & 3
Ex tDA21 EN/ EC 61241-1	Protection by enclosure	21 & 22	2 & 3
Ex tDB21 EN/ EC 61241-1	Protection by enclosure	21 & 22	2 & 3
Ex ibD EN/ EC 61241-11	Intrinsic safety	21 & 22	2 & 3
Ex mbD EN/ EC 61241-18	Encapsulation	21 & 22	2 & 3
Ex pd EN/ EC 61241-4	Pressurised	21 & 22	2 & 3
Ex tDA22 EN/ EC 61241-1	Protection by enclosure	22	3
Ex tDB22 EN/ EC 61241-1	Protection by enclosure	22	3
Ex icD EN/ EC 61241-11	Intrinsic safety	22	3



## ATEX/IEC Ex Zone 1 (Category II) Lighting

Zone 1 products are required when an explosive atmosphere is likely to occur in normal operation occasionally (more than 10 but less than 1000 hours per year). Hazardous areas within customer sites are defined during site audits by competent, trained, independent assessors.

This section contains datasheets for fluorescent, bulkhead, wellglass, and floodlight fittings suitable for use in Zone 1 areas.

Non standard fixing methods and spare parts are documented in the Technical section.

Petrel Limited, 22 Fortnum Close, Kitts Green, Birmingham, B33 0LB United Kingdom  
T +44 (0)121 783 7161 • F +44 (0)121 783 5717 • E sales@petrel-ex.co.uk

[www.petrel-ex.co.uk](http://www.petrel-ex.co.uk)

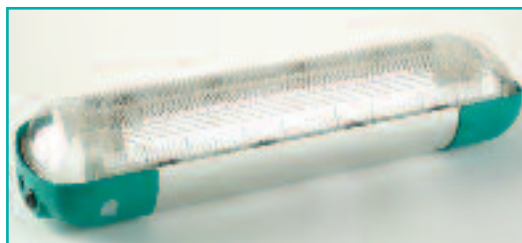



A popular Zone 1 well glass range offering the following benefits:

- Integral Ex e terminal chamber for less corrosion and faster installation
- Long replacement cycle due to robust heavy duty construction
- Wide variety of lamp options, including flashing and rotating beacon options with coloured glass
- Versions suitable for use in high ambient temperatures
- Angled installation possible with pivot bracket accessory
- Internal or external reflectors maximise lamp output

### Typical applications

Chemical sites	Offshore	Paint spray shops	Fuel storage facilities
Refineries	Marine	Grain storage	Water treatment plants
Docks / jetties	Pharmaceutical	Paper mills	Metal treatment plants

### Specification & options

### Lamp Options with 'T' ratings

Specification	Details
Certification Code (Gas)	Ex de IIC Gb T4 or T3
Certification Code (Dust)	Ex tb IIIC Db T4 or T3
Protection type	Ex de (flameproof, increased safety)
ATEX / IECEx type class	Group II Category 2 GD
Certification standards	EN 60079, EN 61241, IEC 60079, IEC 61241
Certificate(s)	SIR00ATEX1048, IEC Ex SIR09.0027
Suitable zoned areas	Zone 1 and Zone 2, Zone 21 and Zone 22
Gas group suitability	IIA, IIB, and IIC
Ambient range (max)	-20°C to 70°C - see lamp types
Material	Corrosion resistant marine grade aluminium body with toughened borosilicate glass dome
Ingress protection (IP rating)	IP66
Cable Entries	2 x M20—ISO (1 plugged) as standard Other threads available
Electrical connections	4 wire and earth. Cable size 4mm <sup>2</sup> max With looping facility
Control Gear (when fitted)	Electro-magnetic ballast, ignitor & capacitor
Supply voltage	Standard 240V 50Hz (Rotating/Flashing versions range from 12 to 277V)
Installation / Mounting	Back mounted fixing strap
Re-lamp access	Via removable screw threaded glass dome
Weight	9kg (beacon/flashing), 9-12kg (Well Glass)

Lamp Type/Lamp Holder	6 Series Beacon/Warning Lights All certified Ex de IIC (gas) and Ex tb IIIC (dust)
Rotating Beacon (ROT) / Integrated	T4@Ta=70°C
Xenon flashing (XEN) / Integrated	T4@Ta=55°C
150W GLS Coloured Beacon (Red, Blue, Green) / E27	T4@Ta=40°C *(55°C)

Lamp Type/Lamp Holder	610 Well Glass All certified Ex de IIC (gas) and Ex tb IIIC (dust)
150W GLS / E27	T4@Ta=40°C *(55°C)
Halogena / E27	T4@Ta=40°C *(55°C)
110W SON (Max) / E27	T4@Ta=40°C *(55°C)
70W SON-R / E27	T3@Ta=55°C
125W MBF / E27	T3@Ta=35°C *(55°C)
80W MBF (Max) / E27	T4@Ta=40°C *(55°C)
25W SL / E27	T4@Ta=70°C
20W PLCE / E27	T4@Ta=70°C

\* Ta when mounted vertically

Accessories	Details
Beacons	A variety of beacons and flashers are available in clear glass, red, blue, green and amber
Reflectors	Internal & External are available (R option)
Wire guard	For glass dome impact protection (WG option)
Pivot bracket	For complete directional control (PB option)
Pendant Mount	Flexible mounting with eyebolts (PM option)



Coloured lens option



Xenon flasher version



Wire guard option

## Fixing, accessories and ordering guide

### How to select your product for ordering

Example: A 6 Series rotating blue beacon with wire guard for UK installation

Model / Lamp type / Mains voltage / Mains frequency / Lens colour / Options

610  
 ↓  
 ROT  
 ↓  
 240  
 ↓  
 50Hz  
 ↓  
 Blue  
 ↓  
 Wire Guard

Product code required is:  
 610 / ROT / 240 / 50 / Blue / WG

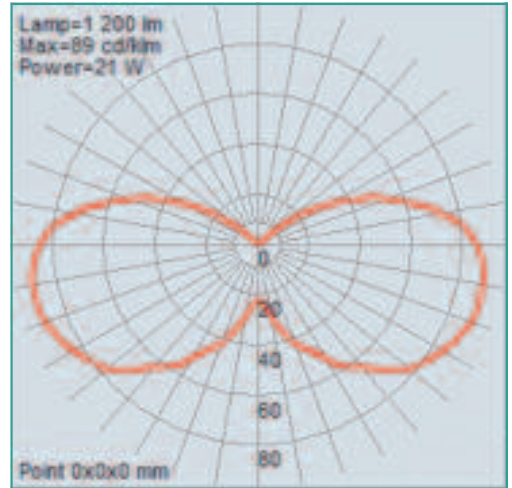

Photometric data available—contact for details

### Fixing & Dimensions/mm

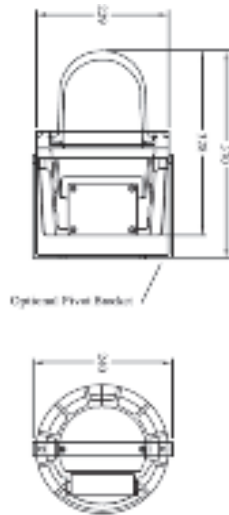

### Mounting Options



Swivel mounting bracket



Eye bolts for pendant mounting. Connection via mounting strap on rear of standard fitting.

### Also available from Petrel

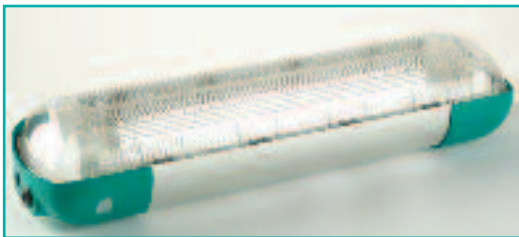

Zone 1 Fluorescent

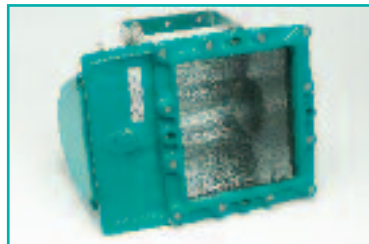

Zone 1 Floodlight

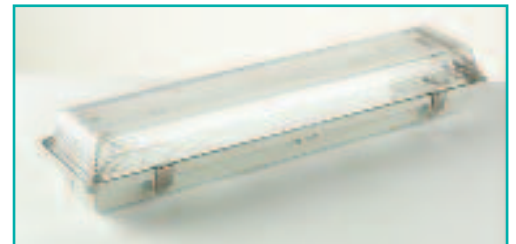

Zone 2 Fluorescent

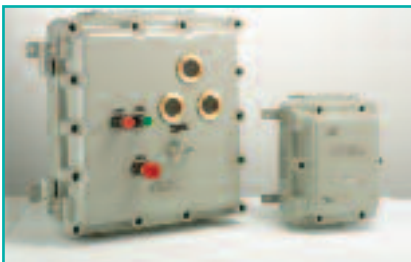

Hazardous area control equipment

[www.petrel-ex.co.uk](http://www.petrel-ex.co.uk)

**Petrel Limited**

22 Fortnum Close, Kitts Green, Birmingham, B33 0LB United Kingdom

T +44 (0)121 783 7161 • F +44 (0)121 783 5717

• E [sales@petrel-ex.co.uk](mailto:sales@petrel-ex.co.uk) • W [www.petrel-ex.co.uk](http://www.petrel-ex.co.uk)

Registered No. 1539429 England

Registered Office: Chuckery Road, Walsall WS1 2DU • VAT No. GB 695 8648 58

**chamberlin plc**

A Chamberlin plc company

# 6 Series Ex de 620 Well Glass 620 QL Long life Well Glass

**ATEX / IECEx  
CERTIFIED**

**CAT II  
ZONE 1**

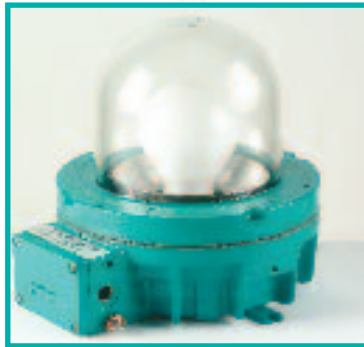

620 Well Glass

A popular Zone 1 fitting offering the following benefits:

- Integral Ex e terminal chamber for less corrosion and faster installation
- Long replacement cycle due to robust heavy duty construction
- Wide variety of lamp options
- Long life QL lamp version for upto 100,000 hours typical use
- Versions suitable for use in high ambient temperatures
- Angled installation possible with pivot bracket accessory
- Internal or external reflectors maximises lamp output
- Marine grade alloy suitable for offshore installation
- Optional stainless steel labels for enhanced record keeping in harsh environments

## Typical applications

Chemical sites	Offshore	Exposed walkways	Fuel storage facilities
Refineries	Marine	Grain storage	Water treatment plants
Docks / jetties	Pharmaceutical	Paper mills	Metal treatment plants

## Specification & options

### 620 Lamp types & 'T' ratings

Specification	Details	Lamp Types/Lamp holder	620 Well Glass
Certification Code (Gas)	Ex de IIC Gb T6 - T2		All certified Ex de IIC (gas) and Ex tb IIIC (dust)
Certification Code (Dust)	Ex tb IIIC Db T6 - T2	<b>300W GLS (max) / E27</b>	T3@Ta=55°C
Protection type	Ex de (flameproof, increased safety)	<b>150W SON / E27</b>	T4@Ta=40°C, T3@Ta=60°C
ATEX / IECEx type class	Group II Category 2 GD	<b>250W SON / E27</b>	T3@Ta=40°C
Certification standards	EN 60079, EN 61241, IEC 60079, IEC 61241	<b>125W HPMV / E27</b>	T4@Ta=40°C, T3@Ta=60°C
Certificate(s)	SIR00ATEX1047X, IEC Ex SIR09.0028	<b>250W HPMV / E27</b>	T3@Ta=39°C
Suitable zoned areas	Zone 1 and Zone 2, Zone 21 and Zone 22	<b>85W QL (max) / Sealed</b>	T5@Ta=40°C, T4@Ta=60°C
Gas group suitability	IIA, IIB, and IIC		
Ambient Range (Max)	-20°C to 110°C - see lamp types	<b>Lamp Types/Lamp holder</b>	<b>620 Well Glass high temperature (HT) version</b> All certified Ex de IIC (gas) and Ex tb IIIC (dust)
Material	Corrosion resistant long life marine grade aluminium body with toughened borosilicate glass dome	<b>300W GLS (max) / E27</b>	T3@Ta=85°C
Ingress protection (IP rating)	IP66	<b>150W GLS / E27</b>	T3@Ta=100°C
Cable Entries	2 x M20—ISO (1 plugged) as standard Other threads available	<b>100W GLS / E27</b>	T4@Ta=40°C, T3@Ta=100°C
Electrical connections	4 wire and earth. Cable size 4mm <sup>2</sup> max With looping facility	<b>150W SON / E27</b>	T3@Ta=90°C
Control Gear (when fitted)	Electro-magnetic ballast, ignitor & capacitor	<b>250W SON / E27</b>	T3@Ta=70°C
Supply voltage	240V 50Hz	<b>250W HPMV / E27</b>	T2@Ta=65°C, T3@Ta=50°C
Installation / Mounting	Back mounted fixing strap	<b>125W HPMV / E27</b>	T3@Ta=90°C
Re-lamp access	Via removable screw threaded glass dome	<b>2x105W Halogen GLS / E27</b>	T3@Ta=85°C
Weight	12.5 - 16.0kg (lamp dependant)	<b>105W Halogen GLS / E27</b>	T4@Ta=40°C, T3@Ta=100°C
		<b>3x70W Halogen GLS / E27</b>	T3@Ta=55°C
		<b>2x70W Halogen GLS / E27</b>	T4@Ta=33°C, T3@Ta=100°C
		<b>70W Halogen GLS / E27</b>	T4@Ta=33°C, T3@Ta=110°C
		<b>2x70W Halogen H1</b>	T4@Ta=33°C, T3@Ta=100°C

Options	Details
Pendant Mount	Flexible mounting with eyebolts (PM option)
Reflectors	Internal & External are available (IR/ER option)
Wire guard	For glass dome impact protection (WG option)
Pivot bracket	For complete directional control (PB option)



External reflector option



Wire guard option



Coloured glass option

## Fixing, accessories and ordering guide

### How to select your product for ordering

Example: A 620 well glass with twin 70W halogen lamps, with reflector and wire guard, for use at high ambient temperatures

Model / Lamp type / Mains voltage / Mains frequency / Options / Options / Options

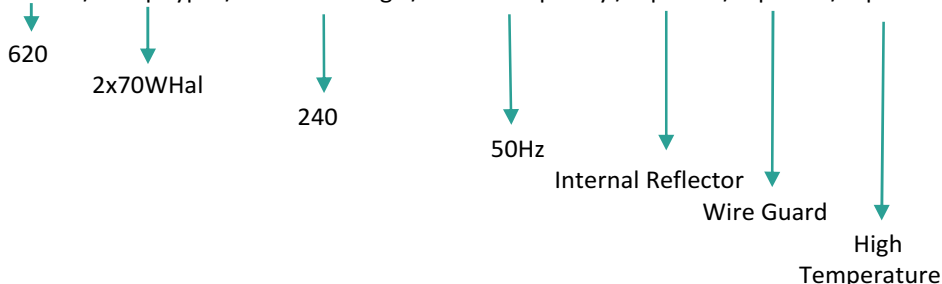

Product code required is:

620 / 2x70HAL / 240 / 50 / IR / WG / HT

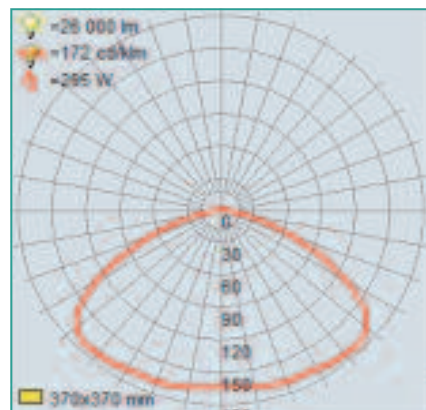

Photometric data available—contact for details

### Fixing & Dimensions/mm

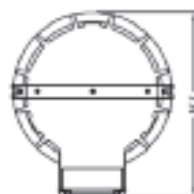
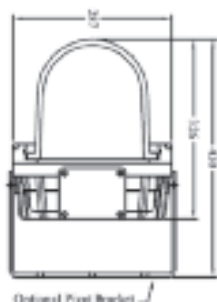

620 Well Glass

### Mounting Options



Swivel mounting bracket



Eye bolts for pendant mounting. Connection via mounting strap on rear of standard fitting.

### Also available from Petrel

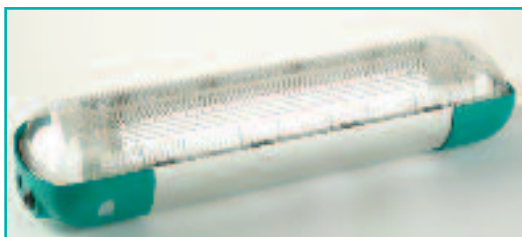

Zone 1 Fluorescent

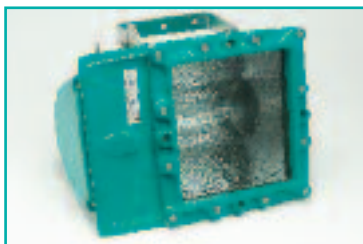

Zone 1 Floodlight

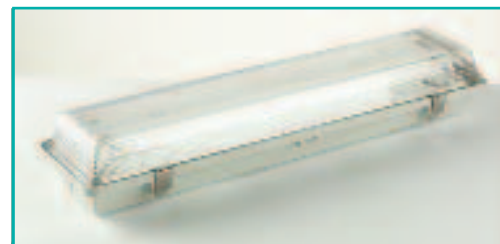

Zone 2 Fluorescent

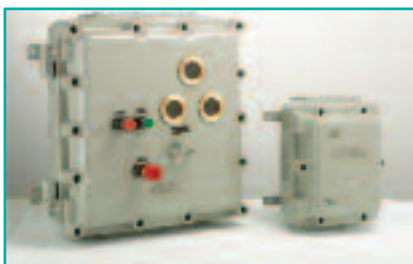

Hazardous area control equipment

[www.petrel-ex.co.uk](http://www.petrel-ex.co.uk)

**Petrel Limited**

22 Fortnum Close, Kitts Green, Birmingham, B33 0LB United Kingdom

T +44 (0)121 783 7161 • F +44 (0)121 783 5717

• E [sales@petrel-ex.co.uk](mailto:sales@petrel-ex.co.uk) • W [www.petrel-ex.co.uk](http://www.petrel-ex.co.uk)

Registered No. 1539429 England

Registered Office: Chuckery Road, Walsall WS1 2DU • VAT No. GB 695 8648 58

**chamberlin plc**

A Chamberlin plc company

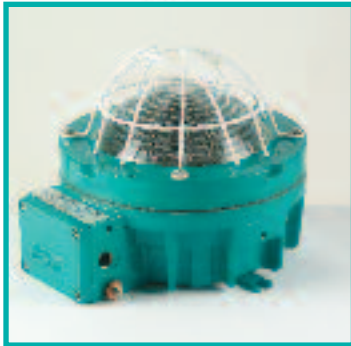

621 Bulkhead with wire guard

A popular Zone 1 fitting offering the following benefits:

- Integral Ex e terminal chamber for less corrosion and faster installation
- Long replacement cycle due to robust heavy duty construction
- Wide variety of lamp options
- Versions suitable for use in high ambient temperatures
- Angled installation possible with pivot bracket accessory
- Internal or external reflectors maximises lamp output
- Low profile bulkhead ideal for walkways and pedestrian access points
- Marine grade alloy suitable for offshore installation
- Optional stainless steel labels for enhanced record keeping in harsh environments

### Typical applications

Chemical sites	Offshore	Exposed walkways	Fuel storage facilities
Refineries	Marine	Grain storage	Water treatment plants
Docks / jetties	Pharmaceutical	Paper mills	Metal treatment plants

### Specification & options

Specification	Details
Certification Code (Gas)	Ex de IIC Gb T6 - T2
Certification Code (Dust)	Ex tb IIIC Db T6 - T2
Protection type	Ex de (flameproof, increased safety)
ATEX / IECEx type class	Group II Category 2 GD
Certification standards	EN 60079, EN 61241, IEC 60079, IEC 61241
Certificate(s)	SIR00ATEX1047X, IEC Ex SIR09.0028
Suitable zoned areas	Zone 1 and Zone 2, Zone 21 and Zone 22
Gas group suitability	IIA, IIB, and IIC
Ambient Range (Max)	-20°C to 100°C - see lamp types
Material	Corrosion resistant long life marine grade aluminium body with toughened borosilicate glass
Ingress protection (IP rating)	IP66
Cable Entries	2 x M20—ISO (1 plugged) as standard Other threads available
Electrical connections	4 wire and earth. Cable size 4mm <sup>2</sup> max With looping facility
Control Gear (when fitted)	Electro-magnetic ballast, ignitor & capacitor
Supply voltage	240V 50Hz
Installation / Mounting	Back mounted fixing strap
Re-lamp access	Via removable screw threaded glass dome
Weight	12.5 - 16.0kg (lamp dependant)

### 621 Lamp types & 'T' ratings

Lamp Types/Lamp Holder	621 Bulkhead
	All certified Ex de IIC (gas) and Ex tb IIIC (dust)
200W GLS (max) / E27	T4@Ta=33°C
125W HPMV / E27	T4@Ta=40°C
80W HPMV / E27	T4@Ta=40°C, T3@Ta=60°C
25W SL / E27	T6@Ta=40°C, T5@Ta=60°C
70W SON / E27	T4@Ta=40°C
Lamp Types/Holder Available	621 Bulkhead high temperature (HT) version
	All certified Ex de IIC (gas) and Ex tb IIIC (dust)
200W GLS (max) / E27	T3@Ta=60°C
125W HPMV / E27	T3@Ta=70°C
80W HPMV / E27	T3@Ta=90°C
25W SL or PLCE / E27	T5@Ta=60°C
70W SON / E27	T3@Ta=90°C
2x70W Halogen GLS / E27	T4@Ta=33°C, T3@Ta=90°C
70W Halogen GLS / E27	T4@Ta=33°C, T3@Ta=100°C

Options	Details
Pendant Mount	Flexible mounting with eyebolts (PM option)
Reflectors	Internal & External are available (IR/ER option)
Wire guard	For glass dome impact protection (WG option)
Pivot bracket	For complete directional control (PB option)



External reflector option

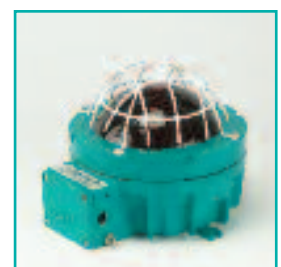

Coloured glass option

# 621 Lamp types & 'T' ratings

## How to select your product for ordering

Example: A 621 bulkhead with twin 70W halogen lamps, with wire guard, for use at high ambient temperatures

Model / Lamp type / Mains voltage / Mains frequency / Options / Options

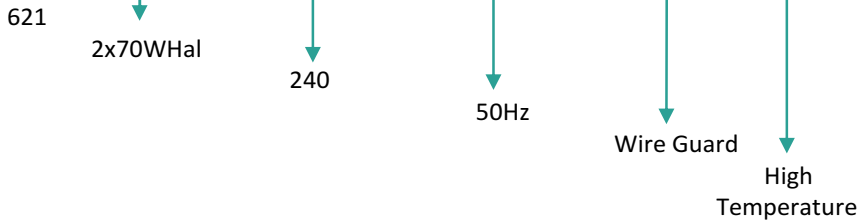

Product code required is:  
621 / 2x70HAL / 240 / 50 / WG / HT

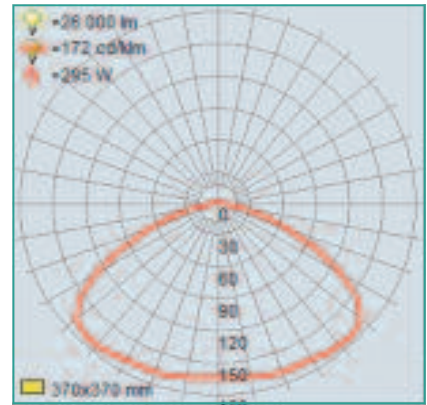

Photometric data available—contact for details

## Fixing & Dimensions/mm

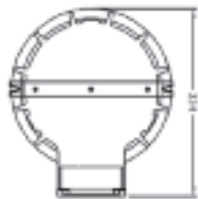
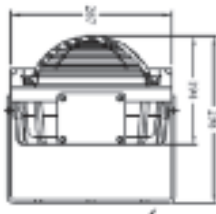

621 Bulkhead

## Mounting Options



Swivel mounting bracket



Eye bolts for pendant mounting. Connection via mounting strap on rear of standard fitting.

## Also available from Petrel

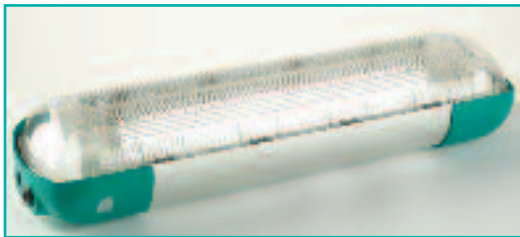

Zone 1 Fluorescent

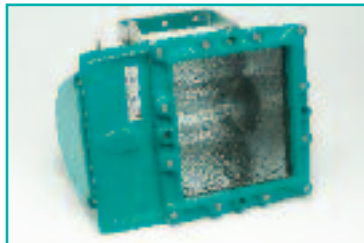

Zone 1 Floodlight

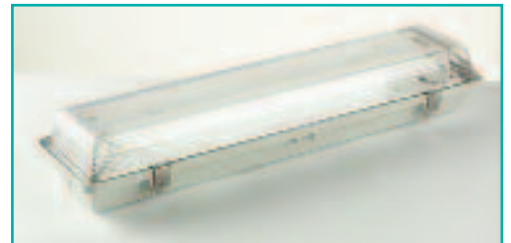

Zone 2 Fluorescent

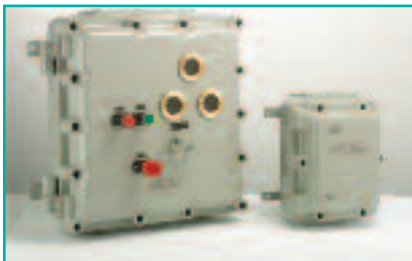

Hazardous area control equipment

[www.petrel-ex.co.uk](http://www.petrel-ex.co.uk)

Petrel Limited

22 Fortnum Close, Kitts Green, Birmingham, B33 0LB United Kingdom

T +44 (0)121 783 7161 • F +44 (0)121 783 5717

• E [sales@petrel-ex.co.uk](mailto:sales@petrel-ex.co.uk) • W [www.petrel-ex.co.uk](http://www.petrel-ex.co.uk)

Registered No. 1539429 England

Registered Office: Chuckery Road, Walsall WS1 2DU • VAT No. GB 695 8648 58

chamberlin plc

A Chamberlin plc company

# 7 Series Ex d LED Fluorescent Replacement Luminaire with optional Motion Sensing

**ATEX**

**CAT II  
ZONE 1**



The 7 Series is a 'd' certified light fitting designed for maximum light output using a wide variety of lamps, including maintenance free LED versions. The LED version offers the following benefits:

- Low maintenance high output LED light source
- Energy efficient control
- Reduced energy costs with motion sensor option controlling single or multiple fittings.
- Robust, long life Zone 1 enclosure
- Available in 1 foot, 2 foot and 4 foot versions
- IP66 Ingress Protection

## Typical applications

Chemical sites	Offshore	Paint spray shops	Waste treatment plants
Refineries	Marine	Grain storage	Water treatment plants
Docks / jetties	Pharmaceutical	Paper mills	Metal treatment plants

## Specification

Specification	Details
Full Certification Code	Ex d II 2G IIB/IIC T6
Protection type	Ex d (flameproof)
ATEX type class	Group II Category 2G T6 @ Ta 55°C
Certification standards	EN 60079-0, -1, -31 IEC 60079-0, -1, -31
Certificate(s)	Sira 01ATEX1033X IECEx 09.0029X
Suitable zoned areas	Zone 1 and Zone 2
Gas group suitability	IIA, IIB, IIC
Material	Marine grade aluminium body with high impact polycarbonate tube
Ingress protection (IP rating)	IP66 minimum
Cable Entries	4 x M20—ISO (3 plugged) as standard. Other threads available.
Electrical connections	3 wire and earth. Cable size 4mm <sup>2</sup> max Through wiring versions available
Light Source	Long life LED
Supply voltage	230V 50/60 Hz
Installation / Mounting	2 x M8 tapped holes
Relamp access	Via threaded end cover and slide out tray
Weight	3kg (size 1), 4.5kg (size 2) 7kg (size 4)

## Ambient temperature 'T' ratings

Lamp Type	7 Series Standard		Certification Type
7LEDS105	434 lm	1 x 5w	T6@Ta=55°C*
7LEDT110	802 lm	2 x 5w	T6@Ta=55°C*
7LEDS210	867 lm	1 x 10w	T6@Ta=55°C*
7LEDT220	1604lm	2 x 10w	T6@Ta=55°C*
7LEDS420	1734 lm	1 x 20w	T6@Ta=55°C*
7LEDT440	3210 lm	2 x 20w	T6@Ta=55°C*

\* To maintain long LED life the maximum ambient temperature should not exceed 45°C

Lamp Type	7 Series Emergency		Certification Type
7LEDS105/EM	434 lm	1 x 5w	T6@Ta=55°C*
7LEDT110/EM	802 lm	2 x 5w	T6@Ta=55°C*
7LEDS210/EM	867 lm	1 x 10w	T6@Ta=55°C*
7LEDT220/EM	1604lm	2 x 10w	T6@Ta=55°C*
7LEDS420/EM	1734 lm	1 x 20w	T6@Ta=55°C*
7LEDT440/EM	3210 lm	2 x 20w	T6@Ta=55°C*





## Sizes & options



Zone 1 LED Single Track

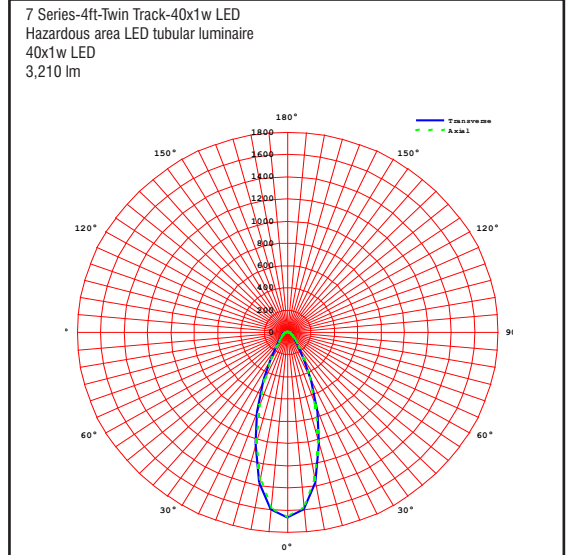

Photometric data available—contact for details

## Fixing & Dimensions

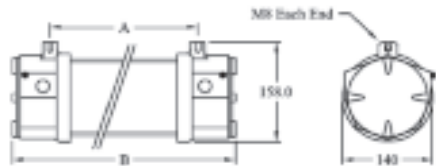

Standard & Compact versions

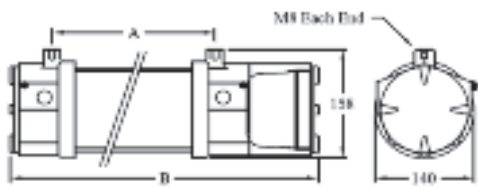

Emergency version

Size/ft	Lamp	A /mm	B/mm	Type available
1	1 or 2 x 8W LED equivalent	335	448	Standard, Emergency*
2	1 or 2 x 18W LED equivalent	632	732	Standard, Emergency*
4	1 or 2 x 36W LED equivalent	1242	1362	Standard, Emergency*

\* add 87mm to B dimension for emergency versions



Easy cable access



Replaceable LED unit

## Also available from Petrel



Zone 1 Wellglass

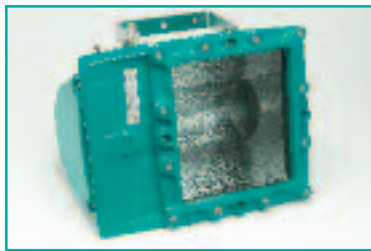

Zone 1 Floodlight

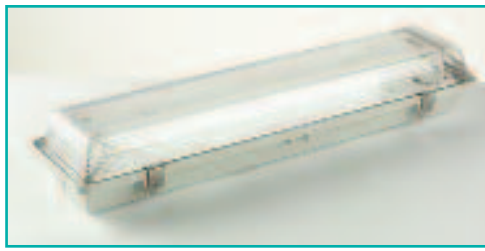

Zone 2 Fluorescent



Industrial Bulkhead



Hazardous area control equipment

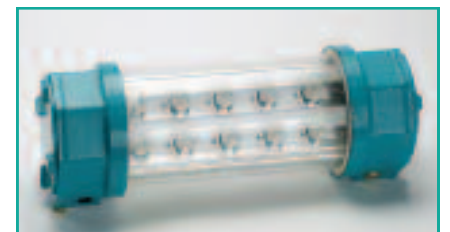

Zone 1 LED Twin

[www.petrel-ex.co.uk](http://www.petrel-ex.co.uk)

Petrel Limited

22 Fortnum Close, Kitts Green, Birmingham, B33 0LB United Kingdom

T +44 (0)121 783 7161 • F +44 (0)121 783 5717

• E [sales@petrel-ex.co.uk](mailto:sales@petrel-ex.co.uk) • W [www.petrel-ex.co.uk](http://www.petrel-ex.co.uk)

Registered No. 1539429 England

Registered Office: Chuckery Road, Walsall WS1 2DU • VAT No. GB 695 8648 58

**chamberlin plc**

A Chamberlin plc company

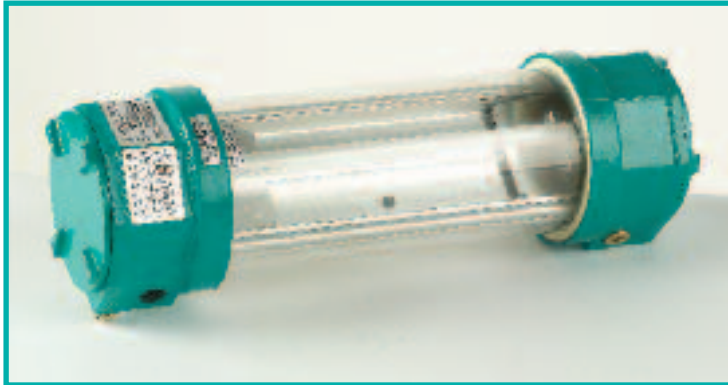

The 7 Series is a 'd' certified light fitting designed for maximum light output using a wide variety of lamps, including power saving low energy compact versions. It offers the following benefits:

- Robust, long life Zone 1 fitting
- Easy access tray for fast re-lamping
- Wide range of voltage options
- Wide range of sizes
- Large range of lamp options
- IP68 versions
- Internally mounted batteries giving 3hr emergency duration
- EOL lamp protection
- 50,000 hour electronic ballast
- Compact lamp version option, more light, less space

### Typical applications

Chemical sites	Offshore	Paint spray shops	Fuel storage facilities
Refineries	Marine	Grain storage	Water treatment plants
Docks / jetties	Pharmaceutical	Paper mills	Metal treatment plants

### Specification & options

Specification	Details
Certification Code (Gas)	II 2 G Ex d IIB/IIC Gb T6, T5 or T4
Certification Code (Dust)	To be confirmed
Protection type	Ex d (flameproof)
ATEX type class	Group II Category 2 G
Certification standards	EN 60079, IEC 60079
Certificate(s)	SIRA01ATEX1033x, IEC Ex SIR09.0029X
Suitable zoned areas	Zone 1 and Zone 2
Gas group suitability	IIA, IIB, and IIC
Material	Marine grade aluminium body with high impact polycarbonate tube
Ingress protection (IP rating)	IP66 minimum
Cable Entries	4 x M20—ISO (3 plugged) as standard. Other threads available.
Electrical connections	3 wire and earth. Cable size 4mm <sup>2</sup> max Through wiring versions available
Control Gear	Electronic ballast
Supply voltage (s)	220-240V, 120-277V, 12V, 24V, 48V call for details of versions available
Installation / Mounting	2 x M8 tapped holes
Relamp access	Via threaded end cover and slide out tray
Weight	3kg (size1), 5kg (size2), 7kg (size4), 8kg (size5), 9kg (size 6) - See over for size details

### Lamp types & 'T' ratings

Lamp Type	7 Series Standard		Certification Type
8W	T5@Ta=40°C	T4@Ta=52°C	Ex d IIC
18W	T6@Ta=40°C	T5@Ta=55°C	Ex d IIC
36W	T6@Ta=40°C	T5@Ta=55°C	Ex d IIB
58W	T6@Ta=40°C	T5@Ta=55°C	Ex d IIB
70W	T5@Ta=40°C	T4@Ta=55°C	Ex d IIB

Lamp Type	7 Series Emergency		Certification Type
8W	T5@Ta=40°C	T4@Ta=52°C	Ex d IIC
18W	T6@Ta=40°C	T5@Ta=55°C	Ex d IIC
36W	T6@Ta=40°C	T5@Ta=55°C	Ex d IIB
58W	T6@Ta=40°C	T5@Ta=55°C	Ex d IIB

Lamp Type	7 Series Compact		Certification Type
11W PL-S	T4@Ta=52°C	T5@Ta=40°C	Ex d IIC
18W PL-L	T4@Ta=52°C	T5@Ta=40°C	Ex d IIC
26W PL-C	T4@Ta=52°C	T5@Ta=40°C	Ex d IIC
36W PL-L	T5@Ta=55°C	T6@Ta=40°C	Ex d IIC
55W PL-L	T5@Ta=55°C	T6@Ta=40°C	Ex d IIC

Lamp Type	7 Series Compact Emergency		Certification Type
18W PL-L	T6@Ta=55°C	T5@Ta=40°C	Ex d IIC
36W PL-L	T5@Ta=55°C	T6@Ta=40°C	Ex d IIC

Accessories	Details
Ballast	Available for all models except non maintained emergency versions
Battery	For emergency versions
Eyebolts/Pole mount bracket	For mounting fittings
Charger inverter	For emergency versions



## Sizes & Lamp options

Size (see below for dimensions)	Versions *	Standard version lamp types /W	Emergency version lamp types /W	Compact version lamp types / W	Compact emergency version lamp types / W
1	S/E/C/CE	8 (S&T)**	8 (S&T)	11, 18, 26 (S&T)	18 (S)**
2	S/E/C/CE	18 (S&T)	18 (S&T)	36, 55 (S&T)	36 (S&T)
4	S/E	36 (S&T)	36 (S&T)	N/A	N/A
5	S/E	58 (S&T)	58 (S&T)	N/A	N/A
6	S	70 (S&T)	N/A	N/A	N/A

\* S = Standard fitting  
 E = Emergency version fitting  
 C = Compact version fitting  
 CE = Compact emergency version fitting  
 \*\* (S&T) = Single and twin tube lamp options  
 (S) = Single tube lamp option

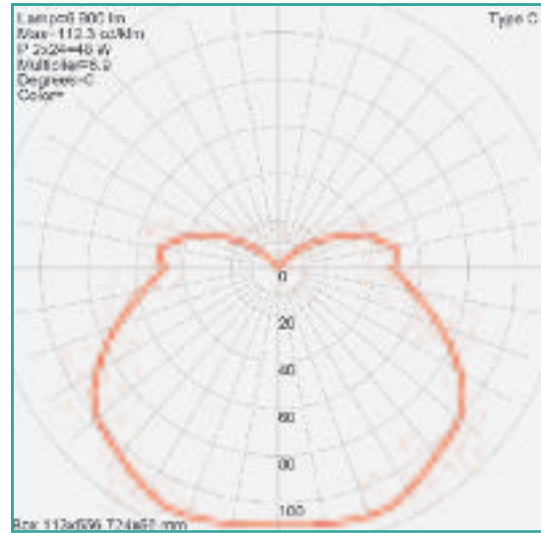

Photometric data available—contact for details

## Fixing & Dimensions

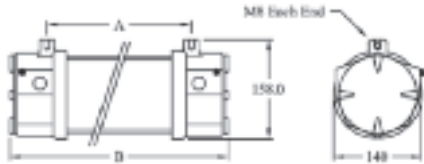

Standard & Compact versions

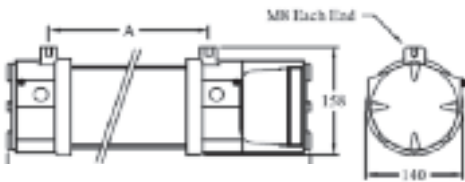

Emergency version

Size/ft	Lamp	A /mm	B/mm	Type available
1	8W	335	448	Standard, Emergency
1	11W, 18W, 26W	335	448	Compact, Compact Emergency*
2	18W	632	752	Standard, Emergency*
2	36W, 55W	632	752	Compact, Compact Emergency*
4	36W	1242	1362	Standard, Emergency*
5	58W	1542	1662	Standard, Emergency*
6	70W	1806	1926	Standard

\* add 87mm to B dimension for emergency versions

## Also available from Petrel



Zone 1 Wellglass

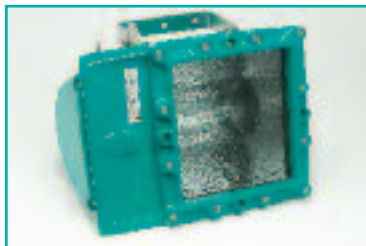

Zone 1 Floodlight

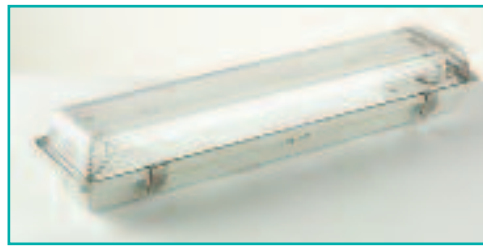

Zone 2 Fluorescent



Industrial Bulkhead



Hazardous area control equipment

[www.petrel-ex.co.uk](http://www.petrel-ex.co.uk)

Petrel Limited

22 Fortnum Close, Kitts Green, Birmingham, B33 0LB United Kingdom

T +44 (0)121 783 7161 • F +44 (0)121 783 5717

• E [sales@petrel-ex.co.uk](mailto:sales@petrel-ex.co.uk) • W [www.petrel-ex.co.uk](http://www.petrel-ex.co.uk)

Registered No. 1539429 England

Registered Office: Chuckery Road, Walsall WS1 2DU • VAT No. GB 695 8648 58

**chamberlin plc**

A Chamberlin plc company

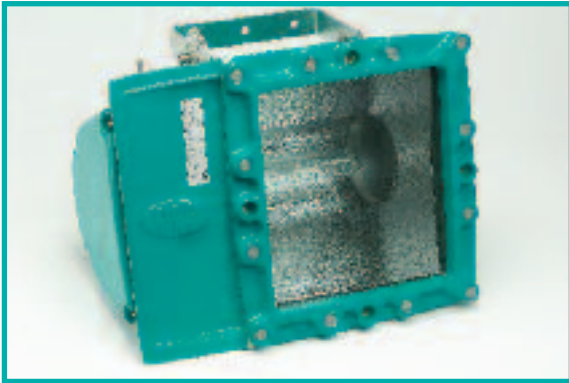

The 8 Series is a 'de' certified light fitting designed for maximum light output offering a wide variety of lamps. It offers the following benefits:

- Robust, long life Zone 1 fitting
- Fast re-lamping through easy access lamping port
- Large range of lamp options
- Easy beam focus with in-situ wide/narrow adjustment
- Accurate angled mounting using optional bracket
- Certified for use in gas and dust zoned applications
- Replaceable glass gives longer life
- Ex e terminal chamber for lower cost glanding

**Typical applications**

Chemical sites	Offshore	Paint spray shops	Fuel storage facilities
Refineries	Marine	Grain storage	Water treatment plants
Docks / jetties	Pharmaceutical	Paper mills	Metal treatment plants

**Specification & options      Lamp options & 'T' ratings**

Specification	Details
Certification Code (Gas)	Ex de IIB Gb T4 or T3
Certification Code (Dust)	Ex tb IIIC Db
Protection type	Ex de (flameproof, increased safety)
ATEX / IECEx type class	Group II Category 2 GD
Certification standards	EN 60079, EN 61241, IEC 60079, IEC 61241
Certificate(s)	SIRA01ATEX1035, IEC Ex SIR09.0030
Suitable zoned areas	Zone 1 and Zone 2, Zone 21 and Zone 22
Gas group suitability	IIA and IIB
Ambient range (max)	-20°C to 55°C - see lamp types
Material	Marine grade corrosion resistant aluminium body and covers with tough Borosilicate glass
Ingress protection (IP rating)	IP66
Cable Entries	2 x M20—ISO (1 plugged) as standard. Other threads available.
Electrical connections	2 wire and earth. Cable size 6mm <sup>2</sup> max with looping facility
Control Gear	Integral within the luminaire with power correction where fitted
Supply voltage	110-270V 50/60 Hz see lamp options
Installation / Mounting	Direct to rear of body, optional graduated angle bracket, or optional pole mount kit
Re-lamp access	Via threaded lamp cover
Weight	29kg to 31 kg depending on lamp type

Lamp Type / E40 Lamp holder in all cases	8 Series 'T' rating All certified Ex de IIB (gas) and Ex tb IIIC (dust)
500W Tungsten (110-127V, AC or DC)	T3@Ta=55°C
500W Tungsten (220-250V AC or DC)	T3@Ta=50°C
250W SON/MBI (up to) (210-250V 50Hz)	T3@Ta=55°C
250W SON/MBI (up to) (230-254V 60Hz)	T3@Ta=55°C
400W SON/MBI (210-250V 50Hz)	T3@Ta=40°C
400W SON/MBI (230-254V 60Hz)	T3@Ta=40°C
250W HPMV (up to) (210-250V 50Hz)	T3@Ta=55°C
250W HPMV (up to) (230-254V 60Hz)	T3@Ta=55°C
400W HPMV (210-250V 50Hz)	T3@Ta=40°C
400W HPMV (230-254V 60Hz)	T3@Ta=40°C

Options	Details
Ballast	Available as spares for models where fitted
Stirrup mount bracket	For accurate angled mounting (Option SM)
Pole mount kit	Sturdy pole mounting bracket kit (Option PM)



# Ordering and fixing options

## How to select your product for ordering

Example: An 8 Series 400W SON with stirrup angle mount bracket for use in the UK

Model / Lamp type / Mains voltage / Mains frequency / Options

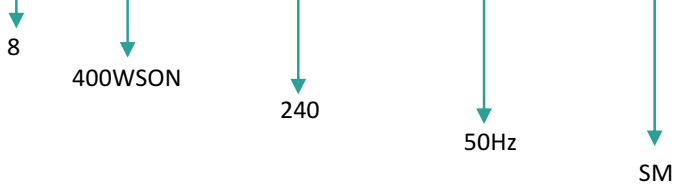

Product code required is:  
8 / 400WSON / 240 / 50 / SM

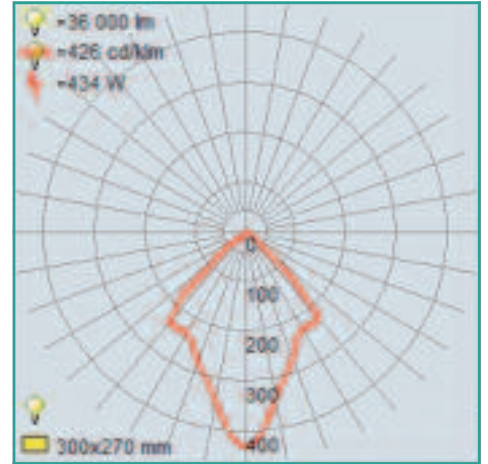

Photometric data available contact for details

## Fixing & Dimensions

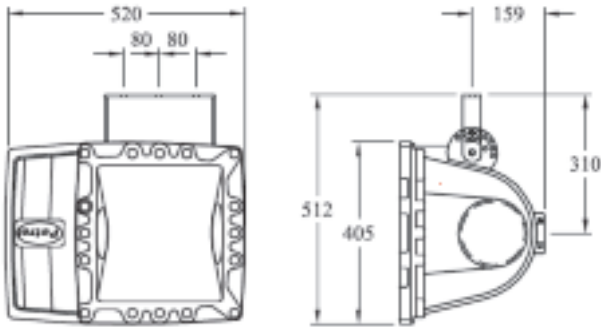

Shown with optional angle mount bracket,  
all dimensions in mm



Pole mount bracket available

## Also available from Petrel



Zone 1 Wellglass



Zone 2 Floodlight

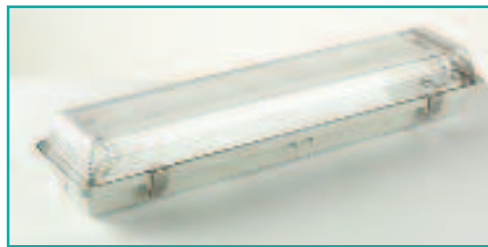

Zone 2 Fluorescent

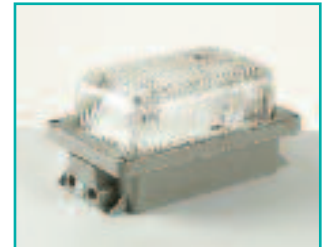

Industrial Bulkhead

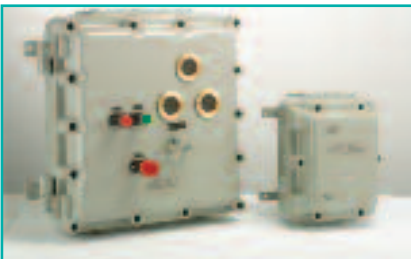

Hazardous area control equipment

[www.petrel-ex.co.uk](http://www.petrel-ex.co.uk)

**Petrel Limited**

22 Fortnum Close, Kitts Green, Birmingham, B33 0LB United Kingdom

T +44 (0)121 783 7161 • F +44 (0)121 783 5717

• E [sales@petrel-ex.co.uk](mailto:sales@petrel-ex.co.uk) • W [www.petrel-ex.co.uk](http://www.petrel-ex.co.uk)

Registered No. 1539429 England

Registered Office: Chuckery Road, Walsall WS1 2DU • VAT No. GB 695 8648 58

**chamberlin plc**

A Chamberlin plc company

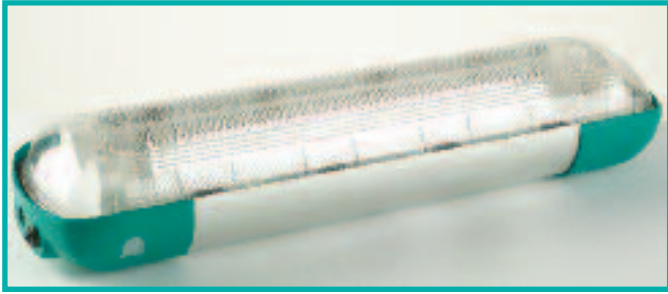

The 9 Series is a 'ed' certified light fitting available with twin lamps in standard and emergency versions. It offers the following benefits:

- Aluminium body prevents twisting and maintains seal during installation
- Captive diffuser with isolation switch for fast, safe re-lamping
- Multi point diffuser locking gives superb sealing properties
- Class leading light output means fewer fittings per installation
- Mounting centres can be varied to your needs for faster installation
- Internally mounted 3hr batteries on emergency version - no need for additional battery box
- Low running costs due to the 50,000 hour electronic ballast

**Typical applications**

Chemical sites	Offshore	Paint spray shops	Fuel storage facilities
Refineries	Marine	Grain storage	Water treatment plants
Docks / jetties	Pharmaceutical	Paper mills	Metal treatment plants

**Specification & options      Lamp types, 'T' ratings & voltages**

Specification	Details
Certification Code (Gas)	Standard version: Ex ed IIC Gb T5 or T4 Emergency version : Ex ed ib IIC Gb T5 or 4
Certification Code (Dust)	Standard & emergency versions: Ex t IIIB T86°C Dc
Protection type	Ex ed (increased safety, flameproof)
ATEX / IECEx type class	Group II Category 2 G
Certification standards	EN 60079, IEC 60079, EN 61241, IEC 61241
Certificate(s)	SIRA00ATEX3071, IEC Ex SIR08.0089
Suitable zoned areas	Zone 1 and Zone 2, Zone 22
Gas group suitability	IIA, IIB, and IIC
Ambient range (max)	-20°C to 55°C - see lamp types
Material	Anodised corrosion resistant aluminium body with high impact UV resistant polycarbonate diffuser
Ingress protection (IP rating)	IP65
Cable Entries	4 x M20—ISO (3 plugged) as standard. Other threads available.
Electrical connections	3 wire and earth. Cable size 4mm <sup>2</sup> max Through wiring versions available
Control Gear	Electronic instant start ballast
Supply voltage	110-277V 50/60 Hz versions available
Installation / Mounting	2 x M8 'Quick fit' bolts on variable centres
Re-lamp access	Via safety held central locked diffuser
Weight	2x18W 7.0kg, 2x36W 11.2kg, 2x58W 13kg

Lamp Type / T8 Tubes	9 Series Standard All certified Ex ed IIC (gas) and Ex t IIIC (dust)	
2 x 18W	T5@Ta=25°C	T4@Ta=55°C
2 x 36W	T5@Ta=25°C	T4@Ta=55°C
2 x 58W	T5@Ta=25°C	T4@Ta=55°C

Lamp Type / T8 Tubes	9 Series Emergency All certified Ex ed ib IIC (gas) and Ex t IIIC (dust)	
2 x 18W	T5@Ta=25°C	T4@Ta=55°C
2 x 36W	T5@Ta=25°C	T4@Ta=55°C
2 x 58W	T5@Ta=25°C	T4@Ta=55°C

Lamp Type / T8 Tubes	9 Series Voltages (all 50/60Hz)	
	Standard	Emergency
2 x 18W	110-120V, 220-240V, 254V, 277V	110-120V, 220-240V
2 x 36W	110-120V, 220-240V, 254V, 277V	110-120V, 220-240V
2 x 58W	220-240V	220-240V

Accessories / Options	Details
Ceiling mounting kit	Pair of Gullwing brackets (Option GW)
Pole mounting kit	50mm Pole mounting kit (Option PC50)
Eyebolts	For pendant mounting fittings (Option PM)
Through wired	For speedier installation (Option TW)

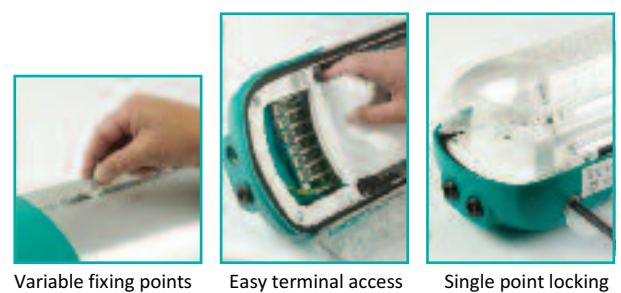

Variable fixing points      Easy terminal access      Single point locking

## Sizes & Lamp options

### How to select your product for ordering

Example: A 9 Series 2 x 36W emergency fitting with pole mount kit for use at 240 volts 50Hz.

Model Lamp type / Emergency / Voltage / Mains frequency / Options / Options

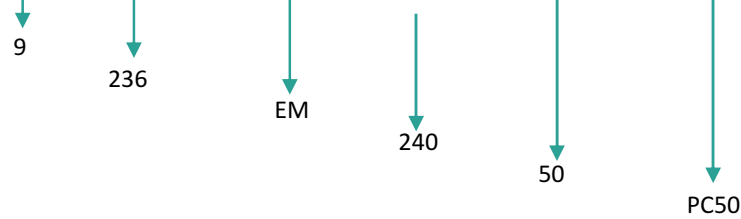

Product code required is:  
9236/EM/240/50/PC50

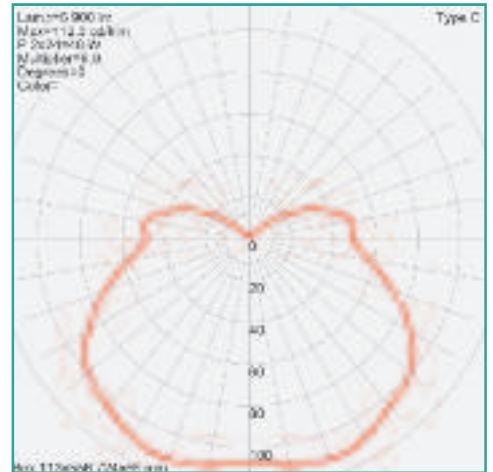

Photometric data available-contact for details

### Fixings & Dimensions - all versions



Lamp	Length A /mm	Fixing centres from 100mm up to
2 x 18W	760	450
2 x 36W	1365	1055
2 x 58W	1665	1355



T bolt standard fixing brackets



Gullwing optional fixing brackets

### Also available from Petrel



Zone 1 Wellglass



Zone 1 Floodlight

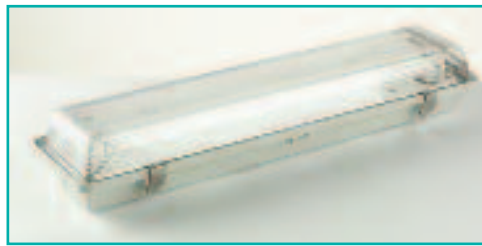

Zone 2 Fluorescent

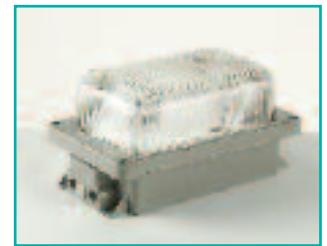

Industrial Bulkhead

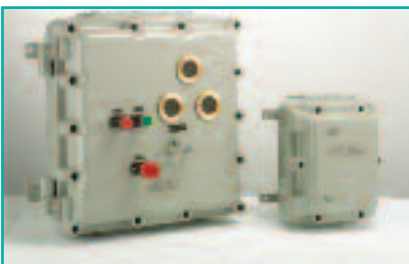

Hazardous area control equipment

[www.petrel-ex.co.uk](http://www.petrel-ex.co.uk)

Petrel Limited

22 Fortnum Close, Kitts Green, Birmingham, B33 0LB United Kingdom

T +44 (0)121 783 7161 • F +44 (0)121 783 5717

• E [sales@petrel-ex.co.uk](mailto:sales@petrel-ex.co.uk) • W [www.petrel-ex.co.uk](http://www.petrel-ex.co.uk)

Registered No. 1539429 England

Registered Office: Chuckery Road, Walsall WS1 2DU • VAT No. GB 695 8648 58

[chamberlin.plc](http://chamberlin.plc)

A Chamberlin plc company



The 9R Series is a 'de' certified recessed light fitting available with twin lamps in standard and emergency versions. It offers the following benefits:

- Quick release diffuser with isolation switch for fast, safe re-lamping
- Flush with ceiling fitting reduces dust build up
- Internally mounted 3hr batteries on emergency version - no need for additional battery box
- Low running costs due to the 50,000 hour electronic ballast

### Typical applications

Chemical site offices	Offshore cabins / accommodation blocks	Fuel storage facilities
Refinery offices	Water treatment plant control cabins	Pharmaceutical laboratories

### Specification & options

### Lamp types, 'T' ratings & voltages

Specification	Details
Certification Code (Gas)	Ex de IIC Gb T5 or T4
Certification Code (Dust)	Ex tb IIIB T135°C Db
Protection type	Ex de (flameproof, increased safety)
ATEX / IECEx type class	Group II Category 2G 3D
Certification standards	EN 60079, IEC 60079, EN 61241, IEC 61241
Certificate(s)	SIRA00ATEX3106 (gas), SIRA09ATEX3317 (dust) IEC Ex SI09.0039 (gas, dust)
Suitable zoned areas	Zone 1 and Zone 2, Zone 22
Gas group suitability	IIA, IIB, and IIC
Ambient range (max)	-20°C to 55°C - see lamp types
Material	Polyester coated steel and toughened glass in an aluminium frame
Ingress protection (IP rating)	IP55
Cable Entries	4 x M20—ISO (3 plugged) as standard.
Electrical connections	3 wire and earth. Cable size 4mm <sup>2</sup> max Through wiring versions available
Control Gear	Electronic instant start ballast
Supply voltage	110-277V 50/60 Hz versions available
Installation / Mounting	4 fixing feet on rear of enclosure
Re-lamp access	Via front glass and quick release diffuser

Lamp Type	9R Series Standard & Emergency versions All certified Ex de IIC (gas) and Ex tb IIIB (dust)	
2 x 18W	T5@Ta=25°C	T4@Ta=55°C
2 x 36W	T5@Ta=25°C	T4@Ta=55°C
2 x 58W	T5@Ta=25°C	T4@Ta=55°C

Lamp Type	9R Series Voltages (all 50/60Hz)	
	Standard	Emergency
2 x 18W	110-120V, 220-240V, 254V, 277V	110-120V, 220-240V
2 x 36W	110-120V, 220-240V, 254V, 277V	110-120V, 220-240V
2 x 58W	220-240V	220-240V

Accessories / Options	Details
Through wired	For speedier installation (Option TW)



Fixing points



Ballast pack



## Sizes & Lamp options

### How to select your product for ordering

Example: A 9R Series 2 x 36W emergency fitting with through wiring for use at 240 volts 50Hz.

Model / Lamp type / Emergency / Voltage / Mains frequency / Options / Options

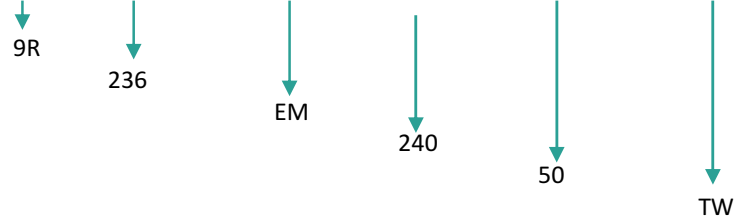

Product code required is:  
9R/236/EM/240/50/TW

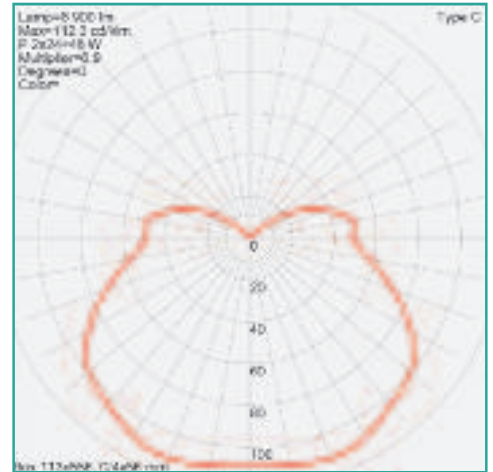

Photometric data available-contact for details

### Fixings & Dimensions - all versions

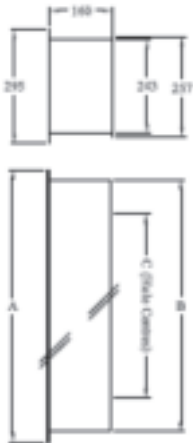

Lamp	A / mm	B / mm	C / mm (fixing centres)	Weight / kg	
				Standard	Emergency
2 x 18W	802	752	642	12.0	12.5
2 x 36W	1402	1352	1242	13.0	13.5
2 x 58W	1702	1652	1542	15.0	15.5

### Also available from Petrel



Zone 1 Wellglass



Zone 1 Floodlight

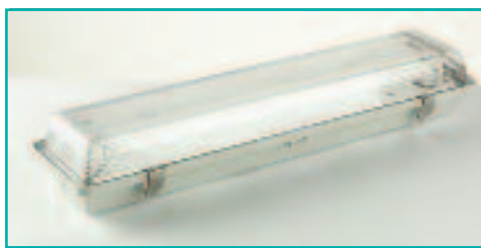

Zone 2 Fluorescent



Industrial Bulkhead

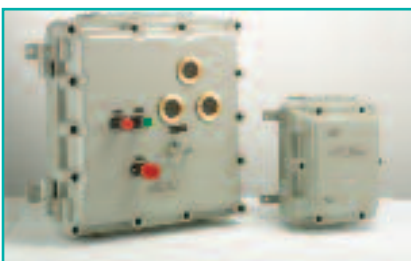

Hazardous area control equipment

[www.petrel-ex.co.uk](http://www.petrel-ex.co.uk)

Petrel Limited

22 Fortnum Close, Kitts Green, Birmingham, B33 0LB United Kingdom

T +44 (0)121 783 7161 • F +44 (0)121 783 5717

• E [sales@petrel-ex.co.uk](mailto:sales@petrel-ex.co.uk) • W [www.petrel-ex.co.uk](http://www.petrel-ex.co.uk)

Registered No. 1539429 England

Registered Office: Chuckery Road, Walsall WS1 2DU • VAT No. GB 695 8648 58

[chamberlin.plc](http://chamberlin.plc)

A Chamberlin plc company

## ATEX/IEC Ex Zone 2 (Category III) Lighting

Zone 2 products are required when an explosive atmosphere is not likely to occur in normal operation occasionally or infrequently and for short periods (less than 10 hours per year).

Hazardous areas within customer sites are defined during site audits by competent, trained, independent assessors.

This section contains datasheets for fluorescent, bulkhead, and floodlight fittings suitable for use in Zone 2 areas.

Non standard fixing methods and spare parts are documented in the Technical section.

Petrel Limited, 22 Fortnum Close, Kitts Green, Birmingham, B33 0LB United Kingdom  
T +44 (0)121 783 7161 • F +44 (0)121 783 5717 • E [sales@petrel-ex.co.uk](mailto:sales@petrel-ex.co.uk)

[www.petrel-ex.co.uk](http://www.petrel-ex.co.uk)

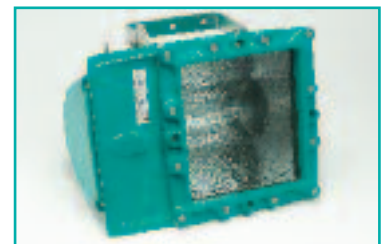
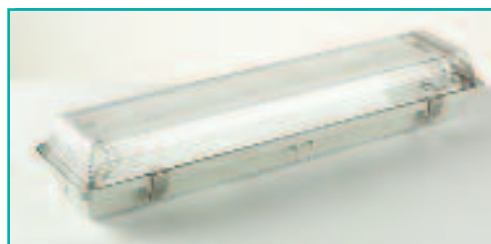

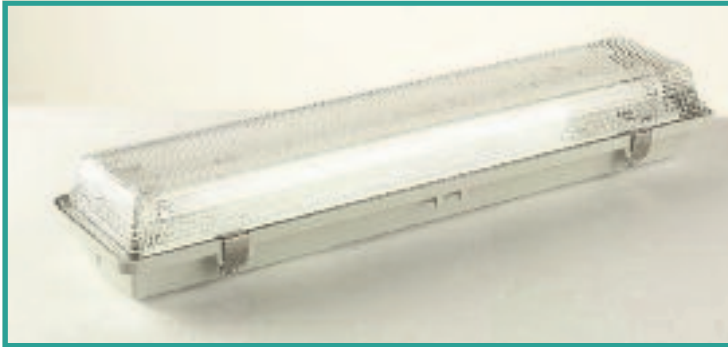

The EXEN Series is a 'nC' certified light fitting available with single or twin lamps in standard and emergency versions. It offers the following benefits:

- Unrestricted breathing concept removes need for costly annual gasket check
- Easy, fast re-lamping using non-corrosive quick release diffuser clips
- Internally mounted 3hr batteries on emergency version - no need for additional battery box
- Optional through wiring for faster installation runs

**Typical applications**

Chemical sites	Offshore	Paint spray shops	Fuel storage facilities
Refineries	Marine	Grain storage	Water treatment plants
Docks / jetties	Pharmaceutical	Paper mills	Metal treatment plants

**Specification & options**

Specification	Details
Certification Code (Gas & Dust)	Ex nA nC tc II T4
Protection type	Ex nA (non sparking) Ex nC (enclosed break)
ATEX / IECEx type class	Group II Category 3GD
Certification standards	EN 60079, IEC 60079, EN 61241, IEC 61241
Certificate(s)	ITS12ATEX47560X, IEC Ex ITS 12.0026X
Suitable zoned areas	Zone 2, Zone 22
Gas group suitability	II
Ambient range (max)	-20°C to 55°C
Material	Tough GRP moulded body, polycarbonate diffuser and coated steel control gear tray. Corrosion resistant clips for gear tray and diffuser
Ingress protection (IP rating)	IP65
Cable Entries	2 x M20—ISO (1plugged) as standard.
Electrical connections	3 wire and earth. Cable size 4mm <sup>2</sup> max Through wiring versions available
Control Gear	Electronic instant start ballast with EOL (end of life) cut off
Supply voltage	230-240V, 50/60 Hz and 110V 50/60Hz (18W and 36W versions only)
Installation / Mounting	Drill through point on enclosure body
Re-lamp access	Quick release spring diffuser clips

**Lamp types and 'T' ratings**

Lamp Type / T8 bi-pin	EXEN Series Standard & Emergency versions All certified Ex nA nC tc.
2 x 18W	T4@Ta=55°C
2 x 36W	T4@Ta=55°C
2 x 58W	T4@Ta=55°C
1 x 36W	T4@Ta=55°C
1 x 58W	T4@Ta=55°C

Accessories / Options	Details
Through wired	For speedier installation (Option TW)
Stainless Steel brackets	Fast installation corrosion resistant bracket (Option SSB)
Gullwing mounting brackets	(Option GWB)



Corrosion resistant clips



Restricted breathing gasket



Quick release gear tray

## Sizes & Lamp options

### How to select your product for ordering

Example: An EXEN Series 2 x 36W emergency fitting with through wiring for use at 240 volts 50Hz.

Model / Lamp type / Emergency / Voltage / Mains frequency / Options / Options

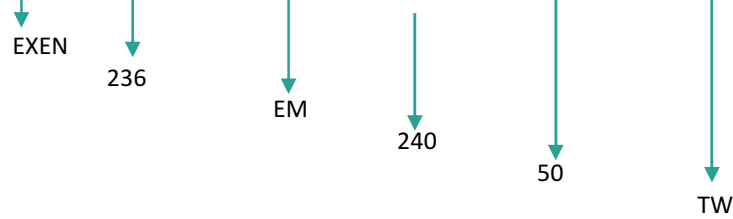

Product code required is:  
EXEN/236/EM/240/50/TW

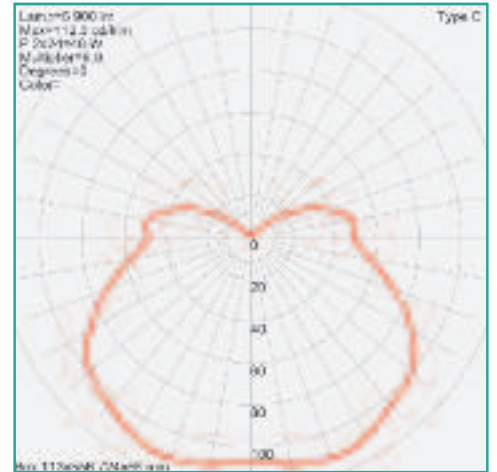

Photometric data available-contact for details

### Fixings & Dimensions - all versions



Stainless steel mounting clips

Lamp	L / mm	W / mm	F / mm (fixing centres)	Weight / kg	
				Standard	Emergency
2 x 18W	702	172	500	2.8	3.8
2 x 36W	1312	172	800	3.6	4.6
2 x 58W	1612	172	1100	5.0	5.6
1 x 36W	1312	102	800	3.2	4.0
1 x 58W	1612	102	1100	3.4	4.2



Gullwing bracket mounting clips

### Also available from Petrel



Zone 1 Wellglass



Zone 1 Floodlight

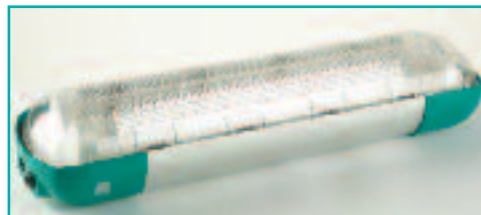

Zone 1 Fluorescent



Industrial Bulkhead

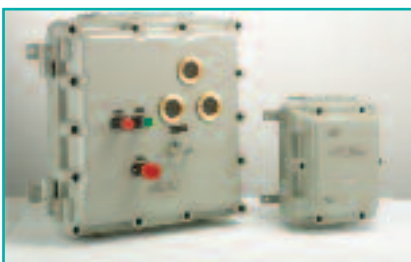

Hazardous area control equipment

[www.petrel-ex.co.uk](http://www.petrel-ex.co.uk)

**Petrel Limited**

22 Fortnum Close, Kitts Green, Birmingham, B33 0LB United Kingdom

T +44 (0)121 783 7161 • F +44 (0)121 783 5717

• E [sales@petrel-ex.co.uk](mailto:sales@petrel-ex.co.uk) • W [www.petrel-ex.co.uk](http://www.petrel-ex.co.uk)

Registered No. 1539429 England

Registered Office: Chuckery Road, Walsall WS1 2DU • VAT No. GB 695 8648 58

**chamberlin plc**

A Chamberlin plc company



The ZT Series is a 'nA' certified floodlight fitting available with a variety of lamp options. It offers the following benefits:

- Hinged lid opening for safe re-lamping
- Graduated angle bracket for fast, accurate installations
- Light weight but strong die cast aluminium construction for long lifetime
- Asymmetric reflector for maximum downward light output

**Typical applications**

Chemical sites	Offshore	Paint spray shops	Fuel storage facilities
Refineries	Marine	Grain storage	Water treatment plants
Docks / jetties	Munitions yards	Paper mills	Metal treatment plants

**Specification & options**      **Lamp types and 'T' ratings**

Specification	Details
Certification Code (Gas and Dust )	Ex nR T4
Protection type	Ex nR (non sparking)
ATEX / type class	Group II Category 3GD
Certification standards	EN 60079
Certificate(s)	10ATEXFZT/01X
Suitable zoned areas	Zone 2, Zone 22
Gas group suitability	II
Ambient range (max)	-20°C to 30°C
Material	Corrosion resistant die cast aluminium body and bezel, toughened glass lens
Ingress protection (IP rating)	IP66
Cable Entries	1 x M20 clearance hole in side of body
Electrical connections	2 wire and earth. Cable size 4mm <sup>2</sup> max
Control gear	Integral within the fitting (where used)
Supply voltage	220-250V, 50/60Hz
Installation / Mounting	'U' shaped stirrup bracket with angle adjustment mechanism
Re-lamp access	2 screws with hinged lid
Weight	19.5kg—21 kg lamp dependent

Lamp Type / Lamp holder	ZT Series Floodlight All certified Ex nR
500W (Max) Tungsten Halogen / E40	T4@Ta=30°C
400W SON (Max) / E40	T4@Ta=30°C
400W MBI (Max) / E40	T4@Ta=30°C
400W HPMV (Max) / E40	T4@Ta=30°C



Cable entry



Terminal access



Graduated angle bracket (Standard)

## Sizes & Lamp options

### How to select your product for ordering

Example: A ZT 150W SON fitting for use at 240 volts 50Hz.

Model / Lamp type / Voltage / Mains frequency / Options / Options

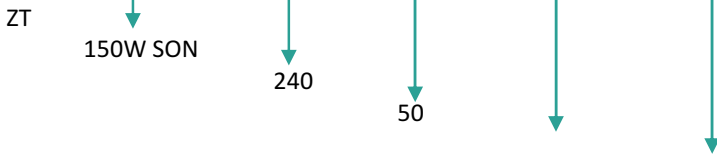

Product code required is:  
ZT/150WSON/240/50

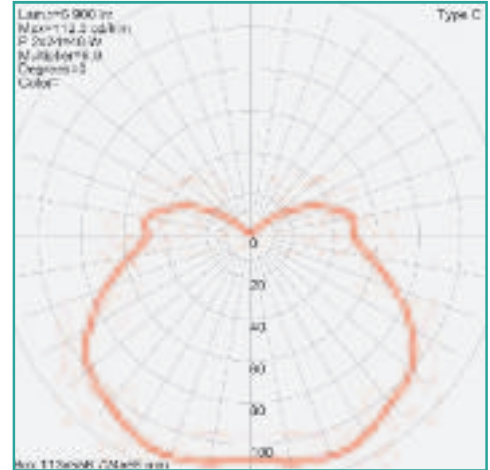

Photometric data available-contact for details

### Fixings & Dimensions - all versions

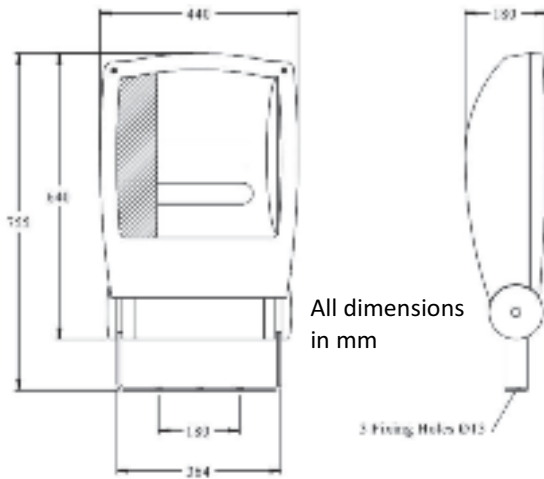

### Also available from Petrel



Zone 1 Wellglass

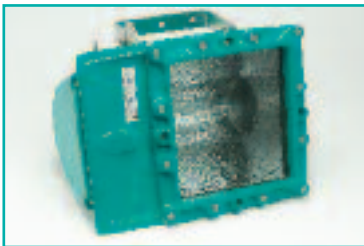

Zone 1 Floodlight



Zone 1 Fluorescent



Industrial Bulkhead

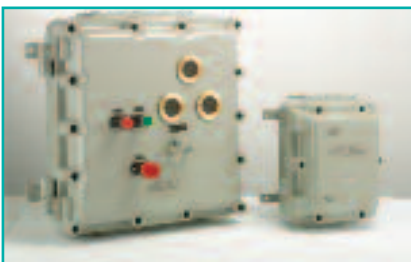

Hazardous area control equipment

[www.petrel-ex.co.uk](http://www.petrel-ex.co.uk)

Petrel Limited

22 Fortnum Close, Kitts Green, Birmingham, B33 0LB United Kingdom

T +44 (0)121 783 7161 • F +44 (0)121 783 5717

• E [sales@petrel-ex.co.uk](mailto:sales@petrel-ex.co.uk) • W [www.petrel-ex.co.uk](http://www.petrel-ex.co.uk)

Registered No. 1539429 England

Registered Office: Chuckery Road, Walsall WS1 2DU • VAT No. GB 695 8648 58

chamberlin plc

A Chamberlin plc company

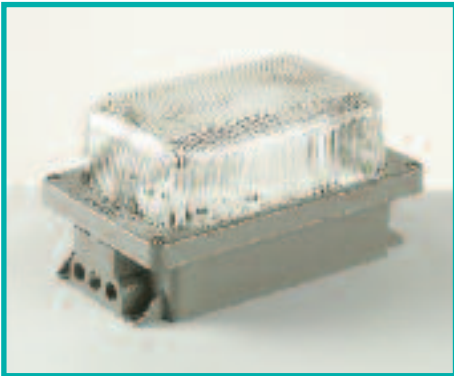

The DN Series is a 'nR' certified light fitting available with a variety of lamp options. It offers the following benefits:

- Hinged lid opening for safe re-lamping
- Robust design for long life
- Non-dazzle, even light distribution due to lens design

### Typical applications

Chemical sites	Offshore	Paint spray shops	Fuel storage facilities
Refineries	Marine	Grain storage	Water treatment plants
Docks / jetties	Water culverts	Paper mills	Metal treatment plants

### Specification & options

Specification	Details
Certification Code (Gas )	Ex nR T3
Protection type	Ex nR (restricted breathing)
ATEX / type class	Group II Category 3GD
Certification standards	EN 60079
Certificate(s)	10ATEXFDN/01
Suitable zoned areas	Zone 2, Zone 22
Gas group suitability	II
Ambient range (max)	-20°C to 30°C
Material	Die cast aluminium body and bezel, borosilicate glass lens
Ingress protection (IP rating)	IP65
Cable Entries	2 x M20—threaded entries at one end. (1 plugged)
Electrical connections	2 wire and earth. Cable size 4mm <sup>2</sup> max
Control gear	Integral within the fitting (where used)
Supply voltage	220-250V, 50/60Hz
Installation / Mounting	4 mounting points (M8 screw size)
Re-lamp access	Remove bezel screws

### Lamp types and 'T' ratings

Lamp Type / all E27 lamp holder, elliptical lamps	DN Series Bulkead fitting
200W GLS (Max)	T3@Ta=25°C
80W MBF	T3@Ta=25°C
70W SON	T3@Ta=30°C



Cable entry



Terminal access



Lamp access

## Sizes & Lamp options

### How to select your product for ordering

Example: A DN 80W MBF fitting for use at 240 volts 50Hz.

Model Lamp type / Voltage / Mains frequency / Options / Options

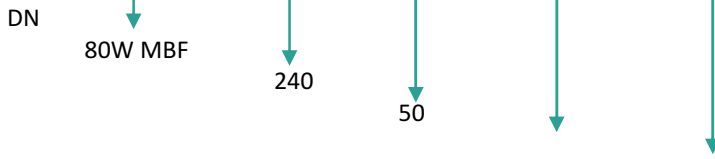

Product code required is:  
DN/80W/240/50

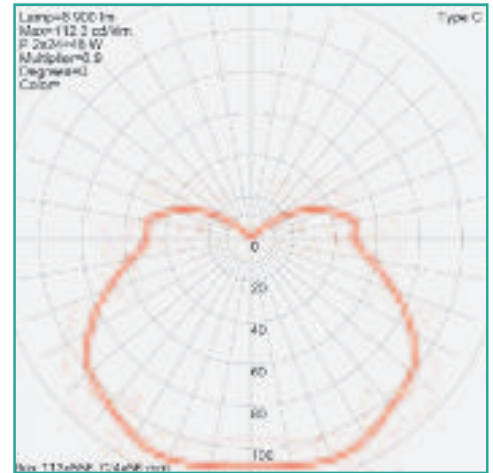

Photometric data available-contact for details

### Fixings & Dimensions - all versions

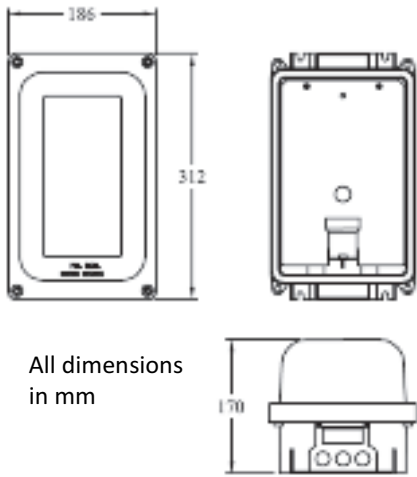

Lamp	Weight / kg
70W SON	6.0
80W MBF	6.0
200W GLS	4.0

### Also available from Petrel



Zone 1 Wellglass



Zone 1 Floodlight

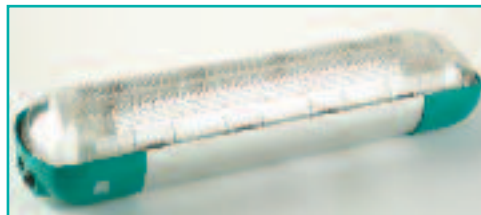

Zone 1 Fluorescent



Industrial Bulkhead

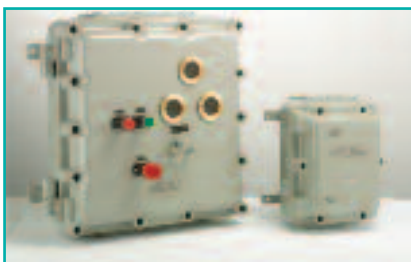

Hazardous area control equipment

[www.petrel-ex.co.uk](http://www.petrel-ex.co.uk)

**Petrel Limited**  
 22 Fortnum Close, Kitts Green, Birmingham, B33 0LB United Kingdom  
 T +44 (0)121 783 7161 • F +44 (0)121 783 5717  
 • E sales@petrel-ex.co.uk • W www.petrel-ex.co.uk  
 Registered No. 1539429 England  
 Registered Office: Chuckery Road, Walsall WS1 2DU • VAT No. GB 695 8648 58

chamberlin plc

A Chamberlin plc company





The 457 is a 'nR' certified light fitting available with GLS lamps up to 150W. It offers the following benefits:

- Virtually unbreakable due to its cast iron construction
- High IP rating means it can be safely used in extreme wet conditions
- Added glass protection with wire-guard option
- Optional through wiring for faster installation runs

**Typical applications**

Chemical sites	Offshore	Fire Fighting training areas	Fuel storage facilities
Refineries	Marine	Grain storage	Water treatment plants
Docks / jetties	Water culverts	Paper mills	Metal treatment plants

**Specification & options**

Specification	Details
Certification Code (Gas )	Ex nC T3 or T6
Protection type	Ex nR (Restricted Breathing)
ATEX / type class	Group II Category 3G
Certification standards	EN 60079
Certificate(s)	10ATEXTF457/01
Suitable zoned areas	Zone 2, Zone 22
Gas group suitability	II
Ambient range (max)	-20°C to 40°C
Material	Cast iron body and bezel, glass lens
Ingress protection (IP rating)	IP68
Cable Entries	1 x M20—threaded entry. Optional extra entry for through wiring.
Electrical connections	2 wire and earth. Cable size 4mm <sup>2</sup> max Through wiring versions available
Supply voltage	220-240V, 50/60Hz
Installation / Mounting	4 mounting points (M8 screw size)
Re-lamp access	Remove bezel screws

**Lamp types, and 'T' ratings**

Lamp Type / Lamp holder	457 Bulkead fitting All certified Ex nR
150W GLS (Max) / E40	T3@Ta=40°C
25W Compact fluo- rescent / E40	T6@Ta=40°C

Accessories / Options	Details
Through wired	For speedier installation (Option TW)
Wire-guard	Plastic coated or galvanised for added glass protection (Option WGP or WGG)



Cable entry



Terminal access



Lamp access



## ATEX Zone 1(Category II) Ex d Enclosures

Zone 1 products are required when an explosive atmosphere is likely to occur in normal operation occasionally (more than 10 but less than 1000 hours per year). Hazardous areas within customer sites are defined during site audits by competent, trained, independent assessors.

This section contains details of our cast aluminium / iron enclosures used in Zone 1 areas to house various control equipment from simple switches to complex process controls.

Petrel Limited, 22 Fortnum Close, Kitts Green, Birmingham, B33 0LB United Kingdom  
T +44 (0)121 783 7161 • F +44 (0)121 783 5717 • E sales@petrel-ex.co.uk

[www.petrel-ex.co.uk](http://www.petrel-ex.co.uk)

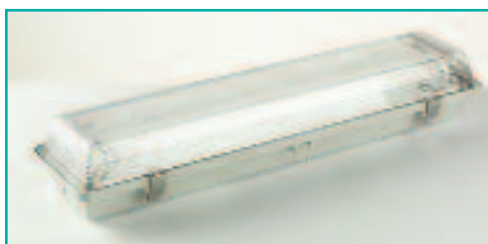



The G20 Series is a range of Ex d certified enclosures suitable for housing a variety of control components. Our standard Motor Starters are 5.5kW to 55kW with or without isolators, and all our enclosures offer the following benefits:

- Maintenance free robust exteriors for long life trouble free operation
- Flexible certification allows for a range of component layouts to suit your requirements
- Variety of sizes to optimize spacial requirements
- Full Ex d certification allows for lower cost standard electrical components to be used inside the enclosure

### Typical applications

Chemical sites	Offshore	Paint spray shops	Fuel storage facilities
Refineries	Marine	Grain storage	Water treatment plants
Docks / jetties	Pharmaceutical	Paper mills	Metal treatment plants

### Specification & options

Specification	Details
Certification Code (Gas)	Ex d IIB T6, T5 or T4
Certification Code (Dust)	Ex tD A21 IP6x T135°C
Protection type	Ex d (flameproof)
ATEX / IECEx type class	Group II Category 2 GD
Certification standards	EN 60079, EN 61241
Certificate(s)	ITS09ATEX16433X
Suitable zoned areas	Zone 1 and Zone 2, Zone 21 and Zone 22
Gas group suitability	IIA and IIB
Ambient range	-20°C to 40°C or 60°C - see power rating table
Material	Heavy duty cast iron or aluminium
Ingress protection (IP rating)	IP66 Max
Cable entry sizes	M20 to M75
Viewing windows	Code            Viewing Diameter/mm W2                22 W3                45 W4                70 W5                105
Exterior finish	2 pack epoxy coating over etching primer

Accessories / Options	Details
Exterior finish	Other colours available, please enquire
Close coupling	Enclosure sizes G22 and above can be close coupled (excluding G22L)

### Power rating and 'T' classes

Enclosure	Ambient : -20°C to 40°C		
	Max Watts for T6 / W	Max Watts for T5 / W	Max Watts for T4 / W
G21	42	64	135
G22	56	85	173
G22L	37	56	110
G23	120	173	345
G24	148	212	400
G25	166	236	432
G27	312	440	768
G28	400	656	1296

Enclosure	Ambient : -20°C to 60°C		
	Max Watts for T6 / W	Max Watts for T5 / W	Max Watts for T4 / W
G21	16	35	93
G22	24	47	119
G22L	16	32	79
G23	56	110	233
G24	64	125	290
G25	71	146	312
G27	144	272	572
G28	190	369	907



Start / Stop switch



Viewing windows



With isolator

### How to select your product for quotation / ordering

We can help you decide the size of enclosure based on your component requirements.

Please provide to us:

Total kilowatt rating

Full current loading

Size and number of cable entries

Voltages and frequencies

For Starters please indicate if DOL, Star Delta, reversing, 2 speed etc

Number and type of buttons

Number and size of viewing windows

For switches, number of poles and current rating

Size and number of terminals

### Dimensions—refer to diagram

Code	Material	A	B	C	D	E	F	G	Weight/ kg
G21	Fe	180	155	145	130	195	7	100	9
G22	Fe	205	205	156	160	230	9	117	19
G22L	Al	200	210	164	145	230	9	128	5
G23	Al	248	316	211	218	230	9	167	13
G24	Al	321	361	228	291	320	11	179	21
G25	Al	366	406	228	250	370	11	177	25
G27	Al	486	516	228	350	480	14	169	49
G28	Al	586	670	294	480	580	14	216	96

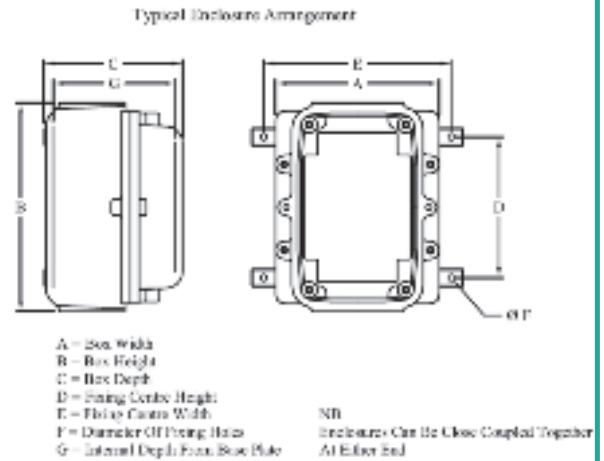

### Also available from Petrel



Zone 1 Wellglass

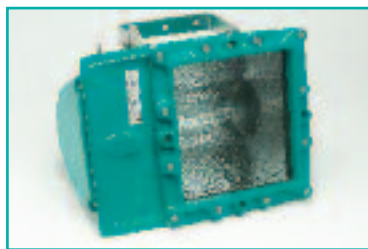

Zone 1 Floodlight

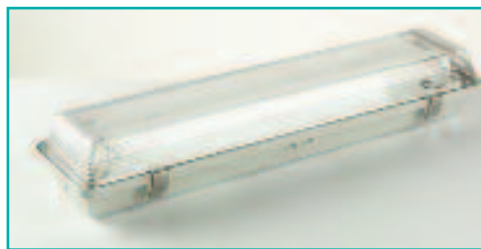

Zone 2 Fluorescent



Industrial Bulkhead

[www.petrel-ex.co.uk](http://www.petrel-ex.co.uk)

Petrel Limited

22 Fortnum Close, Kitts Green, Birmingham, B33 0LB United Kingdom

T +44 (0)121 783 7161 • F +44 (0)121 783 5717

• E [sales@petrel-ex.co.uk](mailto:sales@petrel-ex.co.uk) • W [www.petrel-ex.co.uk](http://www.petrel-ex.co.uk)

Registered No. 1539429 England

Registered Office: Chuckery Road, Walsall WS1 2DU • VAT No. GB 695 8648 58

## Industrial Lighting

Hazardous area designs are by their nature robust, hard wearing and reliable in difficult environments. For this reason we have versions of our most popular designs which we can supply without hazardous area certification and protection concepts, but which retain the exterior robustness of the hazardous area design.

This section contains details of our fluorescent and bulkhead fittings which are available for use in designated safe areas of industrial plants and extreme environments such as offshore wind farms and general marine environments.

Petrel Limited, 22 Fortnum Close, Kitts Green, Birmingham, B33 0LB United Kingdom  
T +44 (0)121 783 7161 • F +44 (0)121 783 5717 • E sales@petrel-ex.co.uk

[www.petrel-ex.co.uk](http://www.petrel-ex.co.uk)

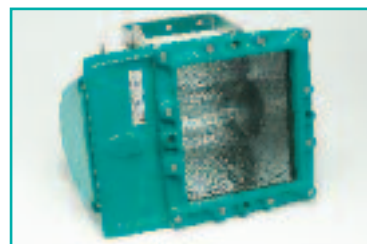
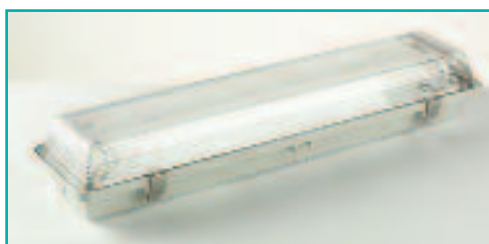

# Defiant Range of Standard & Emergency Fluorescent Luminaire

**SAFE AREA ONLY**

**NOT FOR HAZARDOUS AREAS**

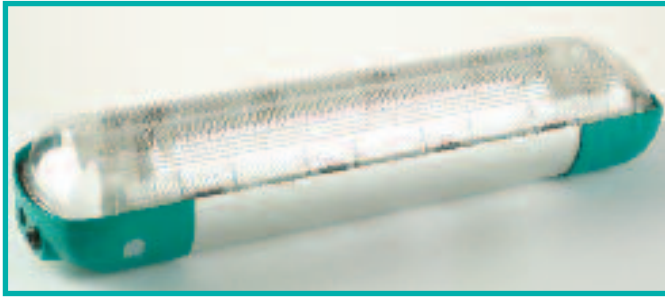

The Defiant is a robust vandal proof industrial light fitting available with twin lamps in standard and emergency versions. It offers the following benefits:

- Aluminium body prevents twisting and maintains seal during installation
- Captive diffuser with isolation switch for fast, safe re-lamping
- Multi point diffuser locking gives superb sealing properties
- Class leading light output means fewer fittings per installation
- Mounting centres can be varied to your needs for faster installation
- Internally mounted 3hr batteries on emergency version - no need for additional battery box
- Low running costs due to the 50,000 hour electronic ballast
- Robust design based on our certified ATEX fitting

**Typical applications - all industrial and commercial sites as well as safe areas of the applications below:**

Chemical sites	Offshore Wind Farms	Warehousing	Fuel storage facilities
Refineries	Marine	Grain storage	Water treatment plants
Docks / jetties	Pharmaceutical	Paper mills	Metal treatment plants

**Specification & options** **Lamp types & voltages**

Specification	Details
Material	Anodised corrosion resistant aluminium body with high impact UV resistant polycarbonate diffuser
Ingress protection (IP rating)	IP65
Cable Entries	4 x M20—ISO (3 plugged) as standard. Other threads available.
Electrical connections	3 wire and earth. Cable size 4mm <sup>2</sup> max Through wiring versions available
Control Gear	Electronic instant start ballast
Supply voltage	110-277V 50/60 Hz versions available
Installation / Mounting	2 x M8 'Quick fit' bolts on variable centres
Re-lamp access	Via safety held central locked diffuser
Weight	2x18W 7.0kg, 2x36W 11.2kg, 2x58W 13kg

Lamp Type / T8 tubes	Defiant Voltages (all 50/60Hz)	
	Standard	Emergency
2 x 18W	110-120V, 220-240V, 254V, 277V	110-120V, 220-240V
2 x 36W	110-120V, 220-240V, 254V, 277V	110-120V, 220-240V
2 x 58W	220-240V	220-240V

Accessories / Options	Details
Ceiling mounting kit	Pair of Gullwing brackets (Option GW)
Pole mounting kit	50mm Pole mounting kit (Option PC50)
Eyebolts	For pendant mounting fittings (Option PM)
Through wired	For speedier installation (Option TW)



Variable fixing points



Easy terminal access



Single point locking

## Sizes & Lamp options

### How to select your product for ordering

Example: A Defiant 2 x 36W emergency fitting with pole mount kit for use at 240 volts 50Hz.

Model Lamp type / Emergency / Voltage / Mains frequency / Options / Options

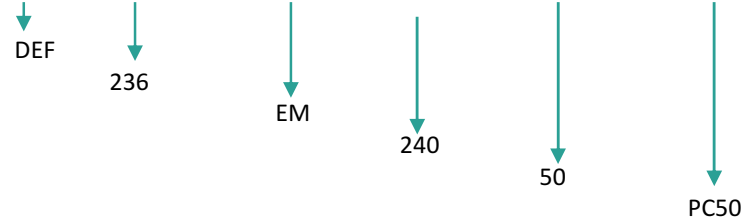

Product code required is:  
DEF/236/EM/240/50/PC50

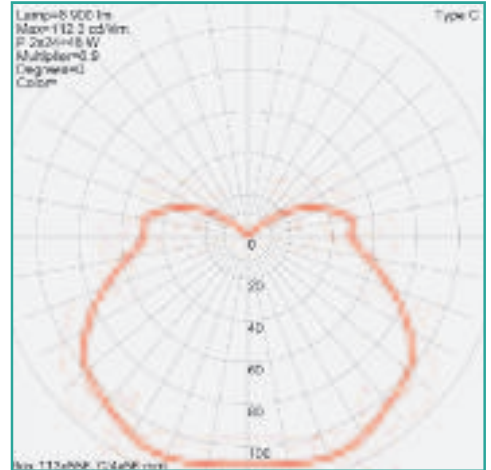

Photometric data available-contact for details

### Fixings & Dimensions - all versions



Lamp	Length A /mm	Fixing centres from 100mm up to
2 x 18W	760	450
2 x 36W	1365	1055
2 x 58W	1665	1355



T bolt standard fixing brackets



Gullwing optional fixing brackets

Also available from Petrel—ATEX and IEC Ex approved products



Zone 1 Wellglass

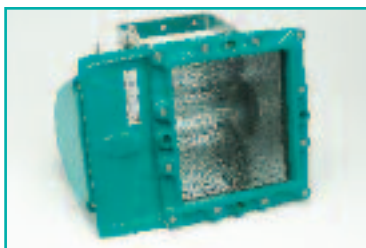

Zone 1 Floodlight

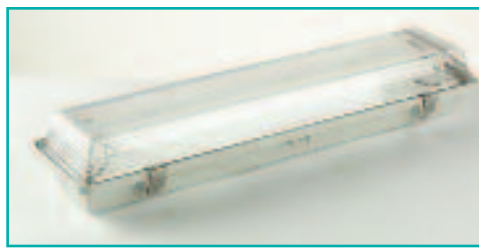

Zone 2 Fluorescent



Industrial Bulkhead

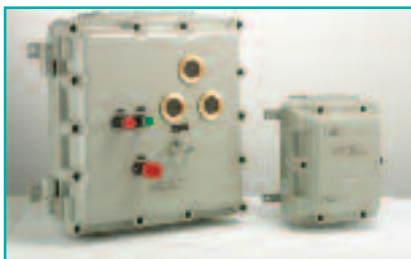

Hazardous area control equipment

[www.petrel-ex.co.uk](http://www.petrel-ex.co.uk)

Petrel Limited

22 Fortnum Close, Kitts Green, Birmingham, B33 0LB United Kingdom

T +44 (0)121 783 7161 • F +44 (0)121 783 5717

• E [sales@petrel-ex.co.uk](mailto:sales@petrel-ex.co.uk) • W [www.petrel-ex.co.uk](http://www.petrel-ex.co.uk)

Registered No. 1539429 England

Registered Office: Chuckery Road, Walsall WS1 2DU • VAT No. GB 695 8648 58

chamberlin plc

A Chamberlin plc company



## Resilient Series Standard & Emergency Fluorescent Luminaire

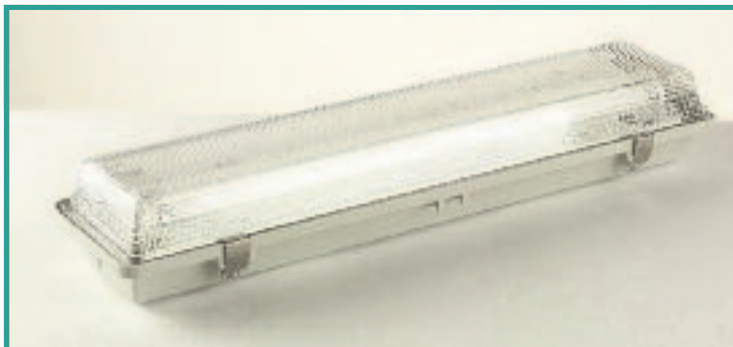

The Resilient Series is a non-corrosive industrial light fitting based on our Zone 2 certified light fitting available with single or twin lamps in standard and emergency versions. It offers the following benefits:

- Designed for hazardous areas provides extra protection in harsh industrial environments
- Easy, fast re-lamping using non-corrosive quick release diffuser clips
- Internally mounted 3hr batteries on emergency version - no need for additional battery box
- Optional through wiring for faster installation runs

**Typical applications - all industrial and commercial sites as well as safe areas of the applications below:**

Chemical sites	Offshore	Warehousing	Fuel storage facilities
Refineries	Marine	Grain storage	Water treatment plants
Docks / jetties	Pharmaceutical	Paper mills	Metal treatment plants

### Specification & options

Specification	Details
Ambient range (max)	-40°C to 55°C
Material	Tough GRP moulded body, polycarbonate diffuser and coated steel control gear tray. Corrosion resistant clips for gear tray and diffuser
Ingress protection (IP rating)	IP65
Cable Entries	2 x M20—ISO (1plugged) as standard.
Electrical connections	3 wire and earth. Cable size 4mm <sup>2</sup> max Through wiring versions available
Control Gear	Electronic instant start ballast with EOL (end of life) cut off
Supply voltage	230-240V, 50/60 Hz
Installation / Mounting	Drill through point on enclosure body
Re-lamp access	Quick release spring diffuser clips

### Lamp types available

Lamp Type / T8 bi-pin	Resilient Series Standard & Emergency versions product codes
2 x 18W	RES/218/HF (/EM for emergency version)
2 x 36W	RES/236/HF (/EM for emergency version)
2 x 58W	RES/258/HF (/EM for emergency version)
1 x 36W	RES/136/HF (/EM for emergency version)
1 x 58W	RES/158/HF (/EM for emergency version)

Accessories / Options	Details
Through wired	For speedier installation (Option TW)
Stainless Steel brackets	Fast installation corrosion resistant bracket (Option SSB)
Gullwing mounting brackets	(Option GWB)



Corrosion resistant clips



Weatherproof gasket



Quick release gear tray

## Sizes & Lamp options

### How to select your product for ordering

Example: A Resilient Series 2 x 36W emergency fitting with through wiring for use at 240 volts 50Hz.

Model / Lamp type / Emergency / Voltage / Mains frequency / Options / Options

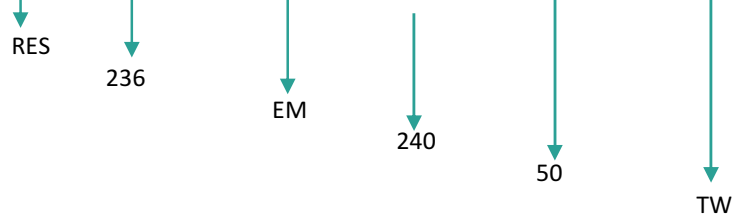

Product code required is:  
RES/236/EM/240/50/TW

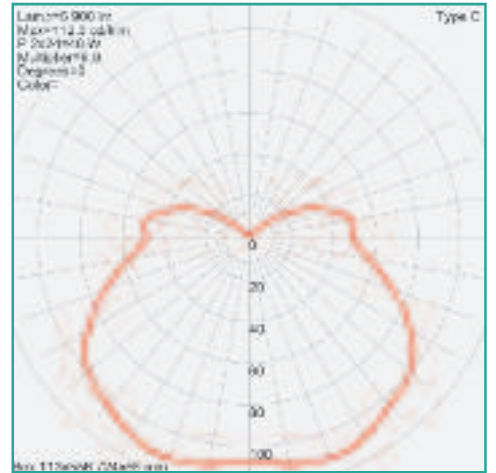

Photometric data available-contact for details

### Fixings & Dimensions - all versions



Stainless steel mounting clips

Lamp	L / mm	W / mm	F / mm (fixing centres)	Weight / kg	
				Standard	Emergency
2 x 18W	702	172	500	2.8	3.8
2 x 36W	1312	172	800	3.6	4.6
2 x 58W	1612	172	1100	5.0	5.6
1 x 36W	1312	102	800	3.2	4.0
1 x 58W	1612	102	1100	3.4	4.2



Gullwing bracket mounting clips

### Also available from Petrel—Hazardous area certified products



Zone 1 Wellglass



Zone 1 Floodlight



Zone 1 Fluorescent



Industrial Bulkhead

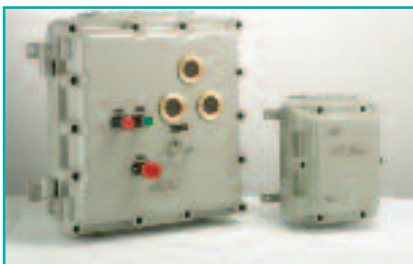

Hazardous area control equipment

[www.petrel-ex.co.uk](http://www.petrel-ex.co.uk)

Petrel Limited

22 Fortnum Close, Kitts Green, Birmingham, B33 0LB United Kingdom

T +44 (0)121 783 7161 • F +44 (0)121 783 5717

• E [sales@petrel-ex.co.uk](mailto:sales@petrel-ex.co.uk) • W [www.petrel-ex.co.uk](http://www.petrel-ex.co.uk)

Registered No. 1539429 England

Registered Office: Chuckery Road, Walsall WS1 2DU • VAT No. GB 695 8648 58

chamberlin plc

A Chamberlin plc company



The DB Series is an industrial bulkhead light fitting available with a variety of lamp options. It offers the following benefits:

- Hinged lid opening for safe re-lamping
- Robust design for long life
- Non-dazzle, even light distribution due to lens design

**Typical applications - Safe area locations in the following and general industrial / commercial use**

Chemical sites	Offshore	Walkways / gantries	Fuel storage facilities
Refineries	Marine	Grain storage	Water treatment plants
Docks / jetties	Water culverts	Paper mills	Metal treatment plants

**Specification & lamp options**

Specification	Details
Ambient range (max)	-20°C to 40°C
Material	Die cast aluminium body and bezel, borosilicate glass lens
Ingress protection (IP rating)	IP65
Cable Entries	2 x M20—threaded entries at one end. (1 plugged)
Electrical connections	2 wire and earth. Cable size 4mm <sup>2</sup> max
Control gear	Integral within the fitting (where used)
Supply voltage	220-250V, 50/60Hz
Installation / Mounting	4 mounting points (M8 screw size)
Re-lamp access	Remove bezel screws

Lamp Type	Lamp Holder
70W SON	E27
80W MBF	E27
200W GLS	E27



Lamp access



Terminal access



Cable entry

## Sizes & Lamp options

### How to select your product for ordering

Example: A DB 80W MBF fitting for use at 240 volts 50Hz.

Model Lamp type / Voltage / Mains frequency / Options / Options  
 ↓ ↓ ↓ ↓ ↓ ↓  
 DB 80W MBF 240 50

Product code required is:  
 DB/80W/240/50

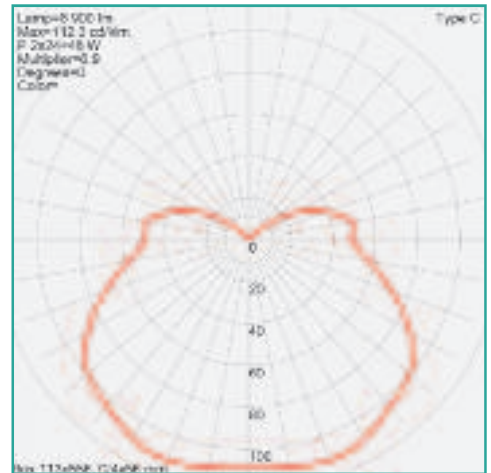

Photometric data available-contact for details

### Fixings & Dimensions - all versions

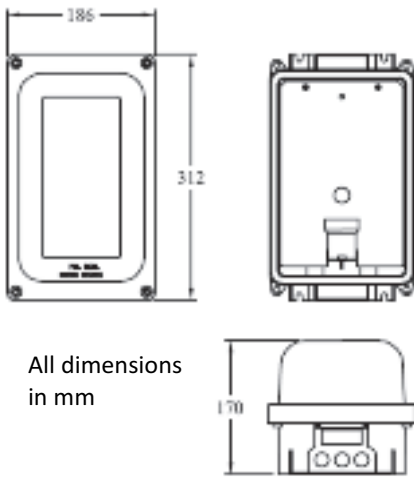

Lamp	Weight / kg
70W SON	6.0
80W MBF	6.0
200W GLS	4.0

Also available from Petrel—products for use in certified hazardous areas



Zone 1 Wellglass

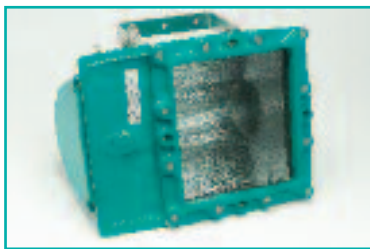

Zone 1 Floodlight



Zone 1 Fluorescent



Industrial Bulkhead

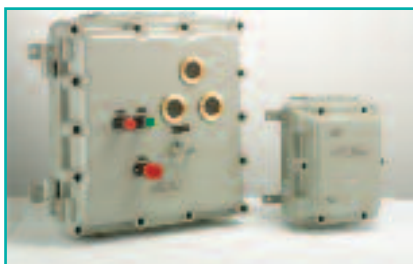

Hazardous area control equipment

[www.petrel-ex.co.uk](http://www.petrel-ex.co.uk)

**Petrel Limited**

22 Fortnum Close, Kitts Green, Birmingham, B33 0LB United Kingdom

T +44 (0)121 783 7161 • F +44 (0)121 783 5717

• E [sales@petrel-ex.co.uk](mailto:sales@petrel-ex.co.uk) • W [www.petrel-ex.co.uk](http://www.petrel-ex.co.uk)

Registered No. 1539429 England

Registered Office: Chuckery Road, Walsall WS1 2DU • VAT No. GB 695 8648 58

**chamberlin plc**

A Chamberlin plc company

## Technical & Spares

Methods of installation can vary from site to site and the following pages show the different fixing methods available for each lighting product.

There is also a comprehensive list of readily available spares should damage occur during the lifetime of the fitting.

If what you require is not available, please contact us.

Petrel Limited, 22 Fortnum Close, Kitts Green, Birmingham, B33 0LB United Kingdom  
T +44 (0)121 783 7161 • F +44 (0)121 783 5717 • E sales@petrel-ex.co.uk

[www.petrel-ex.co.uk](http://www.petrel-ex.co.uk)

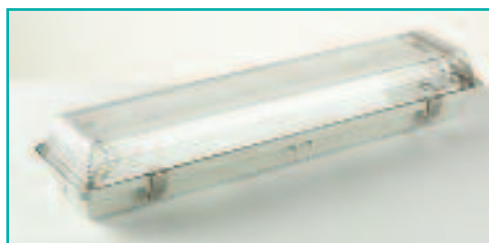

## Technical Extras and Spares

### Mounting options—all products

Optional eyebolts for pendant mounting



Can be used with:  
6 Series (all models)  
7 Series (all versions)  
ExEn (all versions)

Part number  
6H34111177  
6H34111177  
6H34111177

Swivel bracket for angled mounting



Can be used with:  
620  
621

Part number  
4H25180262  
4H2180261



8 Series (all lamp types)

8/STIRUPMNT

Gullwing brackets for when 'in ceiling'  
access is not possible



Can be used with:  
9 Series (all versions)  
ExEn (all versions)

Part number  
GULLWINGBRKIT  
GULLWINGBRKIT

Stainless mounting clip for corrosion  
resistant mounting



Can be used with:  
ExEn Single lamp versions  
ExEn Twin lamp version

Part number  
2415A  
2416A

Pole mount clamps (50mm) for pole, rail  
and stanchion mounting



Can be used with:  
7 Series (all versions)  
9 Series (all versions)  
ExEn (all versions)

Part number  
6LI42084  
6LI42084  
6LI42084

Hinged brackets for angled mounting



Can be used with:  
7 Series (all versions)  
9 Series (all versions)  
ExEn (all versions)

Part number  
6LI42023  
6LI42023  
6LI42023

T bolts and eye bolts for  
universal mounting



Can be used with:  
9 Series - T bolt  
9 Series eyebolt (female)

Part number  
6H61321830  
6LI42082

## Technical Extras and Spares

### 610 Wellglass

Version	Description	Part number
Standard well glass	Wire Guard Kit	2H63057101



Standard well glass	Glass & bezel	2H69004080
---------------------	---------------	------------



### 620 Wellglass

Version	Description	Part number
All	Wire guard	6H24120010



Standard well glass	Glass & bezel	3H69004037
---------------------	---------------	------------



### 621 Bulkhead

Version	Description	Part number
All	Wire guard	5H17410003



Standard well glass	Glass & bezel	2H69004041
---------------------	---------------	------------



### 7 Series Fluorescent

Version	Description	Part number
---------	-------------	-------------

#### Standard

8W single lamp	Ballast	6H31379074
18W single lamp	Ballast	6H31375034T
36W single lamp	Ballast	6H31375036T
58W single lamp	Ballast	6H31375038T
70W single lamp	Ballast	6H31376186
8W twin lamps	Ballast	6H31379074
18W twin lamps	Ballast	6H31375035T
36W twin lamps	Ballast	6H31375037T
58W twin lamps	Ballast	6H31375039T
70W twin lamps	Ballast	6L144069

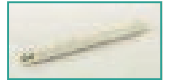

Ballast

#### Emergency

8W single lamp, maintained	Ballast Battery Charger inverter	6H31379074 6H38400026 6H52CHE
----------------------------	---	-------------------------------------

8W single lamp, non- maintained	Ballast Battery Charger inverter	No ballast 6H38400026 6H52CHE
---------------------------------	---	-------------------------------------

18W single lamp, maintained	Ballast Battery Charger inverter	6H31375034T 6H38400028 6H53CHE
-----------------------------	---	--------------------------------------



Ballast

36W single lamp, maintained	Ballast Battery Charger inverter	6H31375036T 6H38400036 6H54CHE
-----------------------------	---	--------------------------------------



Charger inverter

58W single lamp, maintained	Ballast Battery Charger inverter	6H31375038T 6H38400034 6H54CHE
-----------------------------	---	--------------------------------------

8W twin lamp, sustained	Ballast Battery Charger Inverter	6H31379074 6H38400026 6H52CHE
-------------------------	---	-------------------------------------

18W twin lamps, maintained	Ballast Battery Charger inverter	6H31375035V 6H38400028 6H53CHE
----------------------------	---	--------------------------------------



Battery

36W twin lamps, maintained	Ballast Battery Charger inverter	6H31376001 6H38400036 6H54CHE
----------------------------	---	-------------------------------------

58W twin lamps, maintained	Ballast Battery Charger inverter	6H31376001 6H38400034 6H54CHE
----------------------------	---	-------------------------------------

### 8 Series Floodlight

Version	Description	Part number
150W SON/MBI	Ballast	6H31381150
250W SON/MBI	Ballast	6H31381250
400W SON/MBI	Ballast	6H31381400

### 9 Series Fluorescent

Version	Description	Part number
<b>Standard</b>		
18W twin lamps	Ballast c/w lamp holder	2H69001218LH
	Diffuser	6H23400092
36W twin lamps	Ballast c/w lamp holder	2H69001236LH
	Diffuser	6H23400094
58W twin lamps	Ballast c/w lamp holder	2H69001258LH
	Diffuser	6H23400095



Ballast/lamp holder



Diffuser

<b>Emergency</b>		
18W twin lamps	Ballast c/w lamp holder	2H69002218LH
	Diffuser	6H23400092
	Battery	6H38409003A



Battery

36W twin lamps	Ballast c/w lamp holder	2H69002236LH
	Diffuser	6H23400094
	Battery	6H38409003A
58W twin lamps	Ballast c/w lamp holder	2H69002258LH
	Diffuser	6H23400095
	Battery	6H38409004A

### ExEn Fluorescent

Version	Description	Part number
<b>Standard &amp; Emergency</b>		
36W single lamp	Diffuser	A700002B
	Ballast c/w lamp holders	2H69011136LH
	Diffuser clips	G001328A
58W single lamp	Diffuser	A700003C
	Ballast c/w lamp holders	2H69011158LH
	Diffuser clips	G001328A
18W twin lamps	Diffuser	A700019D
	Ballast c/w lamp holders	2H69011218LH
	Diffuser clips	G001328A



Diffuser clips



Ballast pack

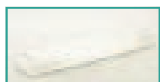

Diffuser

### ExEn Fluorescent continued

Version	Description	Part number
<b>Standard &amp; Emergency</b>		
36W twin lamps	Diffuser	A700004E
	Ballast c/w lamp holders	2H69011236LH
	Diffuser clips	G001328A



Gear tray clip

58W twin lamps	Diffuser	A700005F
	Ballast c/w lamp holders	2H69011258LH
	Diffuser clips	G001328A

### Emergency

36W single lamp	Emergency pack	XN136CHINVEM
	Battery	6H38409003



Emergency pack

58W single lamp	Emergency pack	XN158CHINVEM
	Battery	6H38409004

18W twin lamp	Emergency pack	XN118CHINVEM
	Battery	6H38409003

36W twin lamps	Emergency pack	XN136CHINVEM
	Battery	6H38409003



Battery

58W twin lamps	Emergency pack	XN158CHINVEM
	Battery	6H38409004

### ZT Floodlight

Version	Description	Part number
150W SON/MBI	Ballast	6H31381150
250W SON/MBI	Ballast	6H31381250
400W SON/MBI	Ballast	6H31381400

### DN Bulkhead

Version	Description	Part number
All	Glass	6TL27681009



### Model 457 Bulkhead

Version	Description	Part number
All	Glass	6H23241007





**Supply Voltage Options Guidance—Lighting**

O = Versions available  
 X = Not available  
 ? = Please enquire  
 1 = Requires incandescent lamp (not supplied) that may be obsolete  
 2 = Available only 36W maximum versions

Product	24VAC	24VDC	48VAC	48VDC	110/120V		220/240V		254V		277 V	
					50Hz	60Hz	50Hz	60Hz	50Hz	60Hz	50Hz	60Hz
610 Beacon	O	O	O	O	O	O	O	O	1	1	1	1
610 Flasher	O	O	O	O	O	O	O	O	?	?	?	?
610 Rotating	X	X	X	X	O	O	O	O	X	X	O	O
610 Well Glass	O	O	O	O	O	O	O	O	1	1	1	1
620 Well Glass	O	O	O	O	O	O	O	O	1	1	?	?
621 Bulkhead	O	O	O	O	O	O	O	O	1	1	?	?
7 Series Standard	?	?	?	?	2	2	O	O	2	2	2	2
7 Series Emergency	?	?	?	?	2	2	O	O	X	X	X	X
7 Series Compact	?	?	?	?	2	2	O	O	X	X	X	X
7 Series Compact Em	?	?	?	?	O	O	O	O	X	X	X	X
9/9R Series Standard	X	X	X	X	2	2	O	O	2	2	2	2
9/9R Series Emergency	X	X	X	X	2	2	O	O	X	X	X	X
ExEn Standard	X	X	X	X	O	O	O	O	2	2	2	2
ExEn Emergency	X	X	X	X	2	2	O	O	X	X	X	X
DN Bulkhead	O	O	O	O	O	O	O	O	1	1	1	1
457 Bulkhead	O	O	O	O	O	O	O	O	1	1	1	1
Defiant Industrial Standard	X	X	X	X	2	2	O	O	2	2	2	2
Defiant Ind Emergency	X	X	X	X	2	2	O	O	X	X	X	X
Resilient Industrial Standard	X	X	X	X	O	O	O	O	2	2	2	2
Resilient Ind Emergency	X	X	X	X	2	2	O	O	X	X	X	X
DB Industrial Bulkhead	O	O	O	O	O	O	O	O	1	1	1	1

Product	50 Hz						60 Hz			
	110-127	210	220	230	240	250	110-127	230	240	254
8 Series Floodlight	?	O	O	O	O	O	?	O	O	O
ZT Floodlight	?	O	O	O	O	O	?	O	O	O

## Case Studies

This section contains brief summaries of a selection of applications where Petrel products have been used.

Please note that an example listed here does not indicate that other similar applications will have the same Zone requirement—requirements are determined by site audits.

Petrel Limited, 22 Fortnum Close, Kitts Green, Birmingham, B33 0LB United Kingdom  
T +44 (0)121 783 7161 • F +44 (0)121 783 5717 • E sales@petrel-ex.co.uk

[www.petrel-ex.co.uk](http://www.petrel-ex.co.uk)

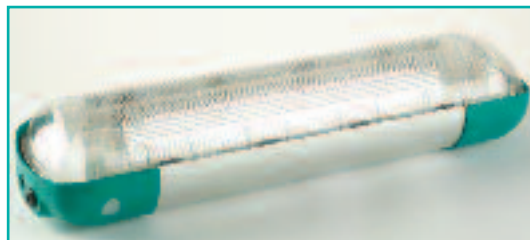

**Gas Turbine Generator Sets**

**Company profile**

A global supplier of Gas Turbines for localized power generation  
 One of four major suppliers of Gas Turbines worldwide

**Business situation**

Historically, the control cabins for gas turbines were lit by a locally supplied, certified hazardous area light fitting of fluorescent lamp type to provide safe illumination for control and maintenance of the generating system.

**Technical situation**

Although more than adequate during the testing and commissioning phase, issues arose due to the tendency of fluorescent fitting components to suffer high degrees of failure in persistent high ambient temperatures. On gas turbine systems, the ambient temperature in the vicinity of the light fittings can rise to between 70°C and 110°C depending on the site location, and this risk of failure of the fitting could cause very expensive downtime. The lighting requirement is a very important part of the safety aspect of operation and maintenance, so a robust solution is critical.

**Solution**

Petrel’s 6 Series was already proven as a robust fitting, based on a wellglass or a low profile bulkhead concept, with the control equipment for the lighting sealed in an Ex d protected body. By clever design, new products have been developed based on the original concept to provide ATEX Zone 1 and IECEx Zone 1 certified light fittings suitable for use in ambient temperatures of up to 110°C.



**Benefits**

By providing a solution using readily available lamp options for the customer, Petrel were able to remove the unreliable nature of the previous fittings, allowing them to ensure longer trouble free operation of the power generation equipment. Simply designed brackets allowed for directional control of the light output, giving a targeted lighting solutions not possible with the previous fluorescent fitting solution. A wide range of wattage lamps allows the customers’ designers to incorporate the optimum number of fittings for the different sizes of gas turbines. Lower headroom issues were solved by using the Petrel 621 low profile bulkhead as an alternative to the wellglass solution.

**Water treatment plant**

**Company profile**

A water authority in Ireland

**Business situation**

As a result of local government drive to improve the handling of waste water facilities in and around Limerick, and new processing plant was commissioned. Supply of the light fittings had to be within 3 weeks from point of order, and international suppliers were invited to bid for the business.

**Technical situation**

Since the handling of waste water can involve the production of flammable gases, the plant required suitably Zoned light fittings to comply with audited health and safety zoning requirements. Previous fittings used in similar environments were prone to water ingress due to flexing of the light fitting bodies during installation. This led to frequent failures of fluorescent tubes and repeated maintenance costs, as well as being potentially hazardous.



**Solution**

Petrel 9 Series light fittings were used in the ‘wet well’ area. This fitting was selected due to its rigid aluminium body ensuring no torsional twisting during installation, which maintains the leak integrity of the fitting.

**Benefits**

By using the Petrel 9 Series with its rigid body in the wet well area, the ingress of water after installation was reduced. Maintenance time on replacing tubes will also be reduced and the maintaining of the seal between the diffuser and the body ensures that safety is not compromised.

### Oilrig Maintenance

#### Company profile

A world renown shipbuilder/maintenance company

#### Business situation

Oilrig downtime is a costly affair, with time away from production costing up to millions of barrels of production. In order to reduce downtime refits are carried out with the utmost attention to detail in order to extend service intervals. One of the key areas for maintenance is the painting required to protect the rig from the rigours of the working environment.

#### Technical situation

Re-spraying an oil rig is a big task and requires large areas with excellent, uniform lighting. Previously the yard had a combination of high bay and task specific lighting, which was prone to 'shadowing' and dark spots.

#### Solution

Petrel's 8 Series was chosen due to it's robust nature, and the size and quality of the flood-light output. Light levels were increased enabling a higher quality of finish to be easily monitored.

#### Benefits

By using the graduated angle brackets, the whole installation could be adjusted on the ground to give the correct angle of flood. This reduced installation time and saved on labour and specialist rigging operatives.



### Warehousing

#### Company profile

A major European motor manufacturer

#### Business situation

A new build warehouse for storage of parts, including paint, led to a last minute requirement for Zone 2 fittings. The building was required to be finished with 6 weeks, with penalty clauses for non-compliance.

#### Technical situation

Originally designated as a high bay style lighting requirement, the extreme height of the proposed racking led to problems with light penetration between the racks.

#### Solution

Petrel ExEn Series light fittings were used following completion of a lighting design scheme by Petrel which demonstrated that ceiling mounted rows of fluorescent fittings between the racking would give the required lux for the same budget as high bays.

#### Benefits

By using the Petrel ExEn Series the uniformity of light between the racking provided a safe working environment. Installation was simple and effective with the through wired option providing easily installed linear cable runs. This fast installation, coupled with fast supply meant no penalties would be imposed due to the lighting of the Zone 2 area. The design and supply was completed in four weeks enabling the work to go ahead on time.



### Military paint spraying

#### Company profile

A major European tank manufacturer

#### Business situation

A refurbishment to comply with European legislation requiring Zone 1 light fittings to replace an existing Zone 2 application

#### Technical situation

A previous installation meant that existing mounting positions existed for the installation. It was a timeframe requirement that the new installation should be carried out quickly using as much of the pre-existing infrastructure as possible.

#### Solution

Painting requires good light quality both for dispersion (uniformity) and brightness. Petrel 9 Series provides both excellent, uniform light dispersion, and its unique diffuser design means more of the light reaches the surfaces required.

#### Benefits

This class leading light output for a given lamp wattage means fewer of the fittings were required, saving on capital cost and ongoing maintenance. In addition, the infinitely variable fixing points on the 9 Series meant that the old fixing centres could be used, removing the need to drill new mounting points and saving on labour costs.





# Petrel Ltd Terms & Conditions

## GENERAL

The placing of an order includes the acceptance of the following terms and conditions. In these General Conditions of Sale the "Company" means Petrel Ltd. The "goods" means the goods agreed to be supplied by the Company and shall where required include services. The "Purchaser" means the person, firm or corporation which has agreed to buy the goods.

These conditions shall apply to and form, every part of every contract of sale entered into between the Company and the Purchaser to the exclusion of any other terms submitted at any time by the Purchaser, and may not be varied without the prior consent in writing of the Company. The Company reserves the right to accept or reject any order received from the Purchaser and to deliver minimum quantities either by value or by reference to the box quantity of the goods in question.

Reference to writing or any other form of communication between the parties shall include telex, facsimile and communication by electronic means.

## QUOTATIONS

Quotations submitted by us shall be valid for the period stated, or where no period is stated then for a period of 30 days from the date of issue.

To avoid higher prices being applied to any contract, the Purchaser must ensure that the quotation reference number is quoted in all purchase orders made by the Purchaser in response to quotations from the Company or where special price agreements are applicable.

## PRICES

The price payable for goods shall be ex-works delivery unless otherwise stated in writing by the Company and be exclusive of VAT and unless otherwise stated in writing be the price as agreed between the Company and the Purchaser or, if there is no agreement as to price, the Company's list price ruling at the date of invoice.

Any query by the Purchaser relating to an invoice must be made in writing within 30 days of invoice date.

Agreed prices are based on quantities intended to be taken by the Purchaser. The Company reserves the right to vary the price if the purchaser fails to take delivery of such quantities within the agreed delivery period, or if no such period is agreed, within a reasonable time.

The Company reserves the right to vary the price of goods to take account of any variations in costs including but not limited to any foreign exchange fluctuation, rates of duties, variations in the cost of wages, materials and other costs of manufacture and distribution, taking effect between quotation and delivery.

Small orders carry a surcharge.

## PAYMENT

For standard account terms (where held), payment in respect of each contract must be made in full by a date which will ensure that payment is received by us not later than the 28th day of the month following the month in which the goods were invoiced. Account terms are available, including part payment, payment in advance, and letter of credit and are determined in advance of order acceptance.

In the event of default in payment by the due date, the Company reserves the right to charge interest on money overdue at 2% above the current base rate of HSBC Bank Plc and to suspend all further deliveries until such payment has been made in full. The Company shall hold the Purchaser liable for all direct costs incurred in collecting any amounts outstanding.

## DELIVERY

All dates for delivery of goods are given in good faith but are approximate only and shall not be of the essence of the contract and shall be calculated from the date of acceptance by the Company of the order of the Purchaser.

Where goods are to be delivered in instalments, each delivery shall constitute a separate contract and failure by the Company to deliver any one or more instalments or any claim by the Purchaser under these conditions shall not entitle the Purchaser to reject further instalments or cancel any further contract.

The Purchaser will sign the Advice Note for the receipt of goods. If the Purchaser signs "unexamined" the Company will deem this to be an acknowledgement of the receipt of all pallets, boxes, cartons or packages specified in the Advice Note.

## LOSS OR DAMAGE IN TRANSIT

If the Company agrees to deliver the goods, the Company will only consider claims for non-delivery or damage in transit if notice is received in writing by the Company within 7 days of the date of the Advice Note in the case of non-delivery of the whole consignment and within 3 working days of receipt of the goods in the case of damage in transit or partial loss of the goods and any associated packing for examination by the

Company. The Company shall not be liable to the Purchaser for any loss or damage whatsoever if the Purchaser fails to notify the Company in accordance with this clause.

## DEFECTS AFTER DELIVERY

We will make good, by repair or at our option by the way of a replacement, defects which under proper use, appear in the goods within a period of 12 calendar months after the goods have been delivered and arise solely from faulty design, materials or workmanship: provided always that defective goods are returned to us unless otherwise arranged. Provided further that in respect of parts or components not of our manufacture then you will be entitled to such benefits as we receive under any guarantee given to us in respect thereof. Our liability under this clause shall be in lieu of any warranty or condition implied by law as to the equality of fitness for any particular purpose of the goods and save as provided in the clause we shall not be under any liability, whether in contract tort or otherwise in respect of defects in goods delivered or for any injury (other than personal injury caused by our negligence as defined in Section 1 of the Unfair Contract Terms Act 1977) damaged or loss resulting from such defects or for any work done in connection therewith.

## VARIATIONS

If at any time after receipt of an order the purchaser wishes to make modifications or additions to the order, the Purchaser shall only be permitted to do so after obtaining the authority in writing of the Company and after the Company has agreed in writing to any variation in the price and/or any revised delivery date.

Any extra cost or liability incurred by the Company due to suspension of work, rescheduling of deliveries or change in order quantity resulting from the Purchaser's instructions or lack of instructions shall be added to the price of the goods and paid accordingly. No variation or derogation from or addition to these Conditions of Sale shall be binding on the Company unless the same is in writing signed for or on behalf of a Director of the Company.

## STORAGE

If the Company does not receive forwarding instructions sufficient to enable it to despatch the goods within 14 days after notification that they are ready for delivery, the Company shall be entitled to invoice and be paid for the goods as though the goods had been duly delivered in accordance with these Conditions. The Company may arrange storage on the Purchaser's behalf and all charges for storage, insurance and demurrage shall be payable by the Purchaser.

## DESCRIPTIVE MATTER AND ILLUSTRATION

All descriptions and illustrations and particulars of weights and dimensions and performance criteria issued by the Company in catalogues, price lists, advertising matter and specifications are by way of general descriptions and approximate only and shall not form part of any contract or give rise to any liability on the part of the Company.

It is the policy of the Company to endeavour to develop and improve its products, and accordingly the Company reserves the right to change all specifications without prior notification or public announcement pursuant to such policy, provided that nothing in this clause shall oblige the Purchaser to accept goods which do not reasonably comply with the contract.

## RETURN OF GOODS

Goods delivered will not be accepted for return without the prior written consent of the Company and in accordance with the Company's returns procedure. The Company reserves the right to charge the Purchaser a handling charge which the Company may deduct from any credit allowed, unless the reason for any return by the Purchaser is due to any fault or breach of these Conditions on part of the Company.

The Company will not allow credit in respect of returned goods not in a fully re-saleable condition.

Any unauthorised goods returned will not be credited and any costs incurred in disposing of them will be borne by the Purchaser.

## WARRANTY

Unless otherwise agreed or where the Company has notified the Purchaser of special terms as to warranty in respect of specified categories of goods the Company agrees at its option either to refund the cost of or repair or replace goods proved to the Company's reasonable satisfaction to have failed under proper storage and use within 12 months of delivery by reason of defects due to faulty design (other than any design, made furnished or specified by the Purchaser) materials or workmanship, provided that:

- The Purchaser shall have followed any instructions issued by the Company in relation to the goods and their storage.
- In the case of defects which would have been apparent to the Purchaser on reasonable examination of the goods on delivery, the Purchaser shall notify the Company of the defects in writing within 14 working days of delivery;

c. In the case of any other defects, the Purchaser shall notify the Company of the defects in writing within 7 working days of the date when the defect becomes apparent;

d. Where in discharge of its obligations under this clause the Company agrees that the Purchaser may undertake any repair work on its behalf, the cost of such work shall be agreed in writing between the Purchaser and the Company before the commencement of such work.

## CONSEQUENTIAL LOSS

Save as may be expressly provided for herein the Company shall not be liable for any consequential loss suffered by the Purchaser, and in particular the Company shall not be liable for any costs, claims, damages or expenses arising out of any tortious act or omission or any breach of contract or statutory duty calculated by reference to profits, income, production or accruals or by reference to accrual of such costs, claims.

## COPYRIGHT

All drawings, descriptions and other information submitted by the Company shall remain the property of the Company together with the copyright therein.

## FORCE MAJEURE

The Company shall be entitled without liability on its part and without prejudice to its other rights, to terminate the contract of any unfulfilled part thereof, or at its option to suspend or make partial deliveries or extend the time or times of delivery, if the manufacture of the goods by the Company or the Company's suppliers, or the delivery of the goods or the performance by the Company of any of its obligations under the contract is hindered or delayed whether directly or indirectly by reason of the Purchaser failing to furnish necessary instructions or information, or by reason of any industrial dispute or any cause beyond the reasonable control of the Company, or its subcontractors, whether or not such cause exists at the date of the Purchaser's order.

## PASSING OF PROPERTY AND RISK

The risk in the goods shall pass to the Purchaser immediately on delivery of the goods to the Purchaser.

The property in the goods shall remain with the Company until payment in full for all the goods and all other goods agreed to be sold by the Company to the Purchaser for which payment is then due, has been received by it in accordance with the terms of the contract.

Until such time as the property in the goods passes to the Purchaser, the Purchaser shall hold the goods on behalf of the Company as a bailee.

While the goods remain the property of the Company, the Purchaser shall keep the goods identifiable and separate from other goods in its possession.

The Company hereby grants to the Purchaser the right to resell the goods, but not as the Company's agent, such right being terminable at the discretion of the Company but in any event upon the insolvency of the Purchaser.

Until such payment as aforesaid has been received in full by the Company, the Purchaser shall be under an obligation to redeliver the goods to the Company if the Company so requires and the Company shall be entitled at any time to retake possession of the goods and for that purpose to enter upon any land or premises of the Purchaser where the goods may be for the time being.

The Company shall be entitled, where the goods have been fixed or attached to any other product, to detach the goods in order to recover possession of them. Such redelivery or retaking of possession shall be without prejudice to the obligation of the Purchaser to purchase the goods.

## PURCHASERS BREACH

In the event of the Purchaser committing any breach of the contract, or if any distress or execution is levied upon the Purchaser, his goods or assets, or if the Purchaser enters into any negotiations for arrangement or composition with or for the benefits of his creditors or commits any act of bankruptcy or if any petition in bankruptcy shall be presented against him, or if, being a corporate body, the Purchaser will be wound up or if any resolution is proposed or petition presented to wind up the Purchaser (not being a members voluntary winding up for the purpose of reconstruction or amalgamation without insolvency), or if an administrator or receiver of the Purchaser's assets or undertaking or any part thereof shall be appointed or if the Purchaser shall be deemed to be unable to pay its debts, the Company shall be entitled, without prejudice to any other claim or right or remedy which it may have, forthwith to suspend any or all deliveries until the default has been made good or to determine the contract or any unfulfilled part thereof.

## LAW

All contracts to which these General Conditions of Sale apply shall be governed by and construed in accordance with English Law.

 **Petrel** <sup>Ex</sup>

**Hazardous Area Equipment**

**T&D** **THORNE &**  
**DERRICK UK**

**Tel:** +44 (0)191 490 1547

**Fax:** +44 (0)191 477 5371

**Email:** [northersales@thorneandderrick.co.uk](mailto:northersales@thorneandderrick.co.uk)

**Website:** [www.cablejoints.co.uk](http://www.cablejoints.co.uk)

[www.thorneandderrick.co.uk](http://www.thorneandderrick.co.uk)



a chamberlin plc  
company