



WWW.CABLEJOINTS.CO.UK
THORNE & DERRICK UK
TEL 0044 191 490 1547 FAX 0044 477 5371
TEL 0044 117 977 4647 FAX 0044 977 5582
WWW.THORNEANDDERRICK.CO.UK

Products for Section 2

- Chemical Industries
- Grain silos
- Oil and Gas industry
- Plastics
- Fertilisers and insecticides
- Wood
- Cosmetics and perfumes
- Alcohol and spirits
- Pharmaceutical Industries, etc.



potentially explosive atmospheres

Decontactors and plugs and socket-outlets for use in explosive atmospheres (from 20 to 125 A)

This section describes the DXN polyester (20, 32 et 63 A) decontactors range. Furthermore, our offer includes:

- PX metal plugs and socket-outlets (20 A),
- DX metal decontactors (32, 63 et 125 A),
- Junction and instrumentation boxes in polyester and metal.

For more information, you can ask for our specific documentation "Products for use in explosive atmospheres" (See at the end of this catalogue).



DXN

DECONTACTOR™ *The range*

Advantages	p. 92
Features	p. 93
Description	p. 94
DXN1 - 20 A	p. 96
DXN3 - 32 A	p. 98
DXN6 - 63 A	p. 100
Dimensions	p. 102



Chemical industry



Oil industry



Grain silos

And perfumes, cosmetics, paints, plastics, fertilisers, alcohol and spirits, pharmaceutical industry ...

ATEX DECONTACTOR™ *with 'ed' safety*

DXN decontactors are designed for explosive atmospheres, with 'ed' protection mode. They comply with the ATEX directives dated 23rd March 1994 and 199/92/CE. They can be used in zones 1 and 2 (*gas*) and zones 21 and 22 (*dust*).

Their main applications are for supplying machines and equipments in explosive atmospheres. Versions including 2 auxiliaries are also available (*DXN 3: 32A/550 V; DXN 6: 63A/550 V*).

Electrical features

- From **20 to 63** Amps - Voltage up to 750 Volts AC (*DXN1: 550 V*) and up to 250 Volts DC.
- Integral switching device as defined in clause 2.8 of IEC / EN 60309-1 standard
- Equipped with silver-nickel butt-contacts and metallic braid for added reliability and lifetime
- Socket-outlet safety shutter provides **IP4X** protection
- Unique keying system allows discrimination between 24 different power supplies (*voltage, frequency, AC and DC current*)
- Number of cycles under normal operation and overload conditions from 2 to 8 times (*depending on rated current*) more than those required by IEC / EN 60309-1 standard
- Versions with **2 auxiliaries** (*DXN3: 32A/550 V ; DXN6: 63A/550 V*)
- **Compatibility: DXN** plugs are compatible with the socket-outlets of the industrial **DSN** range (*except for the DXN6 plug with the DSN6 socket-outlet*).

Mechanical features

- **IP66** and **IP67** automatic watertightness as standard (*resists high pressure washing*)



Align the two red dots (plug and socket-outlet). Push the plug into the socket-outlet: a "click" indicates that connection has been established and that IP66/67 has been achieved.

- Casings made of self-extinguishing non-static glass fibre reinforced **polyester** providing excellent electric insulation, high resistance to corrosive, UV and chemical agent environments and high mechanical resistance (**IK08** impact resistance)
- Casings made of anti-static self-extinguishing polyester allowing the use in ambient temperatures from **-40°C to +40°C** (*for temperatures outside this range, please contact us*).
- Spring-assisted terminals unaffected by vibrations and thermal cycling
- Self-opening lid; self-returning lid on request

Regulatory features

DXN decontactors comply with:

- The **ATEX 94/9/CE** directive,
- The **EN 50014**, **EN 50018** (*explosion proof safety 'd'*) and **EN 50019** (*increased safety 'e'*) european harmonised standards, and the **EN 50281-1-1** (*electrical equipment for use in flammable dust atmospheres*) standard,
- The **IEC 60079-0** (*electrical equipment for use in flammable gas atmospheres - Section 0: General rules*) and **IEC 60079-1** (*'d' safety*) international standards.
- The **IEC 60309-1** International standard and **EN 60309-1** European standard (*plugs and socket-outlets for industrial purposes*),
- The European Low Voltage Directive (*decree N°95-1081 dated 3rd October 1995*),
- The French decree **N° 88-1056** dated 14th November 1988 relating to workers' protection,
- The decrees relating to workers' protection in Belgium, Spain and Italy.

Also certified by **VERITAS LCIE**, **AS** and **CSA** (*French, Australian and Canadian inspection laboratories*).

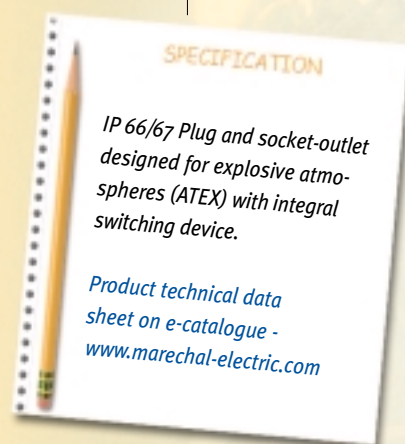



A technology that prevents from all accidents

The DECONTACTOR™ DXN operation provides a high safety to the users. To release the plug, simply press the latch and pull the plug simultaneously (pictures 1 & 2), which breaks the circuit. Then, twist anticlockwise and withdraw the plug (picture 3). This operation is totally safe because the circuit is open.

When the plug and socket-outlet are separated, active parts are protected against the ingress of finger or from wires exceeding 1 mm diameter, thanks to the socket-outlet safety shutter (IP4X protection with open lid).

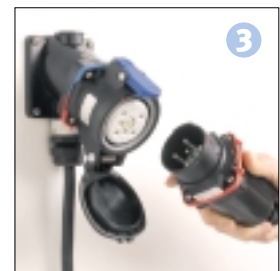
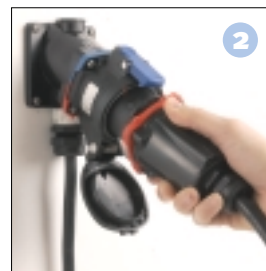
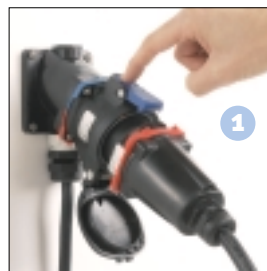

Compliance with the ATEX directive

The DECONTACTOR™ DXN range complies with the new ATEX directive dated 23rd March 1994 **CE** and 199/92/CE.

ATEX Certificate numbers
DXN1: LCIE 99 ATEX 6027X
DXN3: LCIE 00 ATEX 6010X
DXN6: LCIE 02 ATEX 6029X

The DXN are **II 2 G/D Eex ed IIC T6** certified (except for DXN6: 63A: T5 or 60A: T6) for use in zones 1 and 2 (gas) and zones 21 and 22 (dust).

On each DXN DECONTACTOR™ there is a marking whose precise meaning is specified below (example for a DXN1):

II	2	G/D	DUST	T85°C	EEx ed	IIC	T6	LCIE 99 ATEX 6027 X
1	2	3	4		5	4	6	

- Our products are intended to be installed in surface.
- They are category '2', i.e. they can be installed in zone 1 gas (and therefore 2) and zone 21 dust (and therefore 22).
 Reminder: Zone 0 (20): the atmosphere is always explosive
 Zone 1 (21): the atmosphere is occasionally explosive
 Zone 2 (22): the atmosphere is accidentally explosive
- Our products are intended to be installed in explosive gas ('G') or dust ('D') atmospheres.

- In zone 21 (dust), the maximum product temperature is 85°C for ambient temperature of 40°C: their temperature class is therefore T6.
- The protection modes of our products are 'e' (increased safety: terminals, enclosures ...) and 'd' (explosion proof gaskets for arc chambers), IIC means that our products can be installed in all types of gas including the most hazardous ('C' gases subdivision including hydrogen).
- Name of laboratory, year of certification and ATEX certificate part number. The DXN1 was ATEX certified in 1999 at LCIE.



Marechal's modular system

DXN deconnectors meet the modularity system described on the Bookmark. Before consulting the 'part number' pages, determine the parts required for the needed configuration.



Example : a wall mounting socket-outlet includes an active part, the socket-outlet (female) and an installation accessory,

the wall box. Each part has its own part number. Therefore, the order should have two part numbers.

DXN part number system

- **Standard** DXN part numbers are made up of 7 characters. All part numbers start with a '2'.
- The choice of an **option** or a **version with auxiliary contacts** results in adding a suffix (from 1 to 3 characters).

1 st character	2 nd character	3 rd character	4 th character	Characters from 5 to 7		
Range	Casing	Rated current	Usage	Supply voltage**	Frequency	Polarity
2 = DXN	5 = Black poly	1 = DXN1 (20 A) 3 = DXN3 (32 A) 6 = DXN6 (63 A)	4 = Socket-outlet 8 = Inlet	08A = 20 - 24 V 033 = 190 - 230 V 015 = 220 - 250 V 013 = 380 - 440 V 017 = 380 - 440 V	50 Hz 50 Hz 50 Hz 50 Hz 50 Hz	2P 3P+E 1P+N+E 3P+E 3P+N+E
			A = Installation accessory	753 = Handle 027 = Inclined sleeve B53 = Wall box		

** 24 different power supplies (voltage, frequency) and 12 polarities are available: see international standard and colour-code on page 8

Check that the DXN part number meets the need ...

Example : the need is for a 20A, 400V, 3P+E black poly wall mounting socket.

- The DXN with a 20A rated current is **DXN1** (see pages 96 and 97).
- Order a **20 A socket-outlet (S)** and a **wall box (B)**.
- In the standard socket-outlet part number table, select the part number for a 400V, 3P+E socket-outlet: **25 14 013**
- In the standard wall box part number table, choose the accessory that suits you e.g. a 30° poly wall box with a M20 threaded entry and a cable gland: **25 1A B53**

Vérification des deux références trouvées :

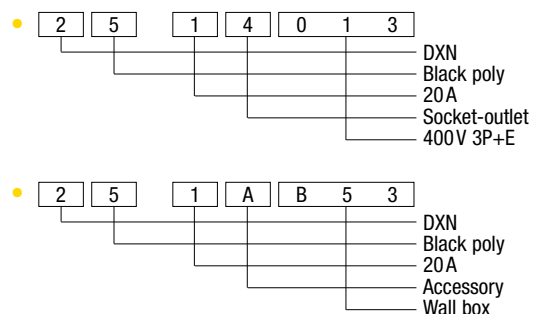

DXN₁

DECONTACTOR™ 20 A



Main features:

• (socket-outlet) IP	66/67	• Wiring (mini / maxi) flexible	1 / 4 mm ²
• (socket-outlet + inlet) IP	66/67	• Wiring (mini / maxi) stranded	1.5 / 6 mm ²
• IK	08	• Other wiring on request	
• U _{max}	550 V AC - 250 V DC	maxi flexible / stranded	10 / 16 mm ²
• Rated currents (IEC / EN 60309-1)			20 A / 550 V

S Socket-outlet (female)

I Inlet (male)



Main options



Padlocking shaft
(Padlock not supplied)

Accessories



IP67 Inlet cap

Voltage	Polarity	Material	Part #
20 - 24 V	2P	Polyester	25 14 08A
190 - 230 V	3P+E	Polyester	25 14 033
220 - 250 V	1P+N+E	Polyester	25 14 015
380 - 415 V	3P+E	Polyester	25 14 013
Dual voltage*	3P+N+E	Polyester	25 14 017

Voltage	Polarity	Material	Part #
20 - 24 V	2P	Polyester	25 18 08A
190 - 230 V	3P+E	Polyester	25 18 033
220 - 250 V	1P+N+E	Polyester	25 18 015
380 - 415 V	3P+E	Polyester	25 18 013
380 - 415 V	3P+N+E	Polyester	25 18 017

* See Bookmark
Other voltages, polarities: see page 8

Socket-outlet options

Self-returning lid	Socket # +	R
180°-opening lid	Socket # +	10
180°-opening and self-returning lid	Socket # +	18
Padlocking shaft for 1 padlock 3 mm Ø	Socket # +	840
Padlocking shaft up to 3 padlocks 3 mm Ø	Socket # +	844

If you want to equip a socket-outlet with two or more options:
call us at +33 (0) 1 45 11 60 00.

Inlet accessories

IP67 cap	25 1A	126
----------	-------	------------

Also see:

Dimensions page 102
Technical Manual page 150

Installation accessories

B Box



Wall box
poly 30°



Wall box
poly 70°

Entry		Tightening		Tightening
M20	25 1A B53	8 - 13 mm	25 1A B58	8 - 13 mm
M25			25 1A B58 25P	13 - 19 mm
M32			25 1A B58 32P	17 - 25 mm

Cable gland 'e' included

Sl Sleeve



Inclined
poly 30°



Inclined
poly 70°

25 1A 027	25 1A 757
------------------	------------------

H Handle



Straight poly
with poly cable gland

Entry		Tightening
M20	25 1A 753	8 - 13 mm
M25	25 1A 253 25P	13 - 19 mm
M32	25 1A 253 32P	17 - 25 mm

Portable
stainless
steel box
'ed'

Please consult us.



ZOOM DXN1 / DSN1 compatibility

The DXN1 'ed' plugs can be connected both to DXN1 'ed' socket-outlets / coupler sockets and to DSN1 industrial socket-outlets / coupler sockets.

Thus you can move mobile 'Ex' devices equipped with a DXN1 plug in and out of your 'Ex' zones.

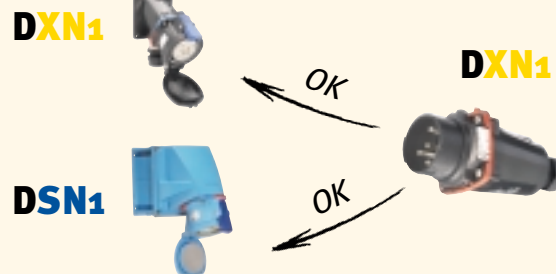

On the other hand, it is not possible to connect DSN1 industrial plugs to DXN1 socket-outlets / coupler sockets.

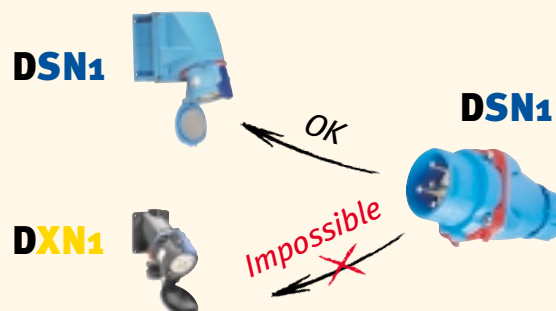

DXN₃ DECONTACTOR™

32 A



Main features:

- | | | |
|------------------------------|-------|---|
| • (socket-outlet) IP | 66/67 | • U _{max} 750 VAC (with 2 auxiliaries: 550 V) - 250 V DC |
| • (socket-outlet + inlet) IP | 66/67 | • Wiring (mini/ maxi) flexible 2.5 / 10 mm ² |
| • IK | 08 | • Wiring (mini/ maxi) stranded 2.5 / 16 mm ² |
-
- Rated currents (IEC / EN 60309-1) 32 A / 750 V (with 2 auxiliaries: 550 V)

S Socket-outlet (female)

I Inlet (male)

Main options



Padlocking shaft
(Padlock not supplied)

Accessories



IP67 Inlet cap



Voltage	Polarity	Material	Part #
20 - 24 V	2P	Polyester	25 34 08A
190 - 230 V	3P+E	Polyester	25 34 033
220 - 250 V	1P+N+E	Polyester	25 34 015
380 - 440 V	3P+E	Polyester	25 34 013
Dual voltage*	3P+N+E	Polyester	25 34 017

Voltage	Polarity	Material	Part #
20 - 24 V	2P	Polyester	25 38 08A
190 - 230 V	3P+E	Polyester	25 38 033
220 - 250 V	1P+N+E	Polyester	25 38 015
380 - 440 V	3P+E	Polyester	25 38 013
380 - 440 V	3P+N+E	Polyester	25 38 017

* See Bookmark
Other voltages, polarities: see page 8

Socket-outlet (U_{max} 550 V) with auxiliary contacts

With 2 auxiliary contacts (5A) Socket # + 972

If you want to add an option to this kind of socket-outlet:
call us at +33 (0) 1 45 11 60 00.

Socket-outlet options

Self-returning lid	Socket # + R
180°-opening lid	Socket # + 10
180°-opening and self-returning lid	Socket # + 18
Padlocking shaft for 1 padlock 3 mm Ø	Socket # + 840
Padlocking shaft up to 3 padlocks 3 mm Ø	Socket # + 844

If you want to equip a socket-outlet with two or more options:
call us at +33 (0) 1 45 11 60 00.

Inlet (U_{max} 550 V) with auxiliary contacts

With 2 auxiliary contacts (5A) Inlet # + 972

Inlet accessories

IP67 cap	25 3A 126
----------	-----------

Also see:

Dimensions page 102
Technical Manual page 150

Installation accessories

B Box



Wall box
poly 30°



Wall box
poly 70°

Entry		Tightening		Tightening
M20	25 3A B53	8 - 13 mm	25 3A B58 20P	8 - 13 mm
M25			25 3A B58	13 - 19 mm
M32			25 3A B58 32P	17 - 25 mm

Cable gland 'e' included

Sl Sleeve



Inclined
poly 30°



Inclined
poly 70°

25 3A **027** 25 3A **757**

H Handle



Straight poly
with poly cable gland

Entry		Tightening
M20	25 3A 753	8 - 13 mm
M25	25 3A 783	13 - 19 mm
M32	25 3A 253 32P	17 - 25 mm
M40	25 3A 253 40P	24 - 32 mm

Portable
stainless
steel box
'ed'

Please consult us.



ZOOM DXN3 / DSN3 compatibility

The DXN3 'ed' plugs can be connected both to DXN3 'ed' socket-outlets / coupler sockets and to DSN3 industrial socket-outlets / coupler sockets.

Thus you can move mobile 'Ex' devices equipped with a DXN3 plug in and out of your 'Ex' zones (except the DXN3 version with auxiliary contacts).

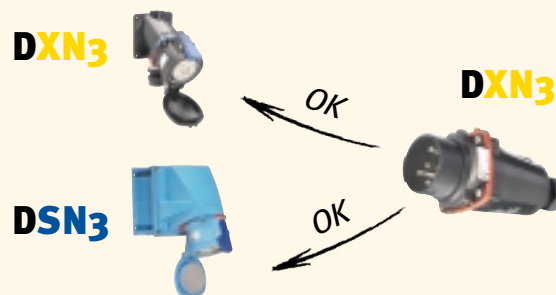

On the other hand, it is not possible to connect DSN3 industrial plugs to DXN3 socket-outlets / coupler sockets.



DXN6 DECONTACTOR™

63A



Main features:

- (socket-outlet) IP 66/67
 - (socket-outlet + inlet) IP 66/67
 - IK 08
 - U_{max} 750 VAC (with 2 auxiliaries: 550 V) - 250 V DC
 - Wiring (mini/ maxi) flexible 6 / 16 mm²
 - Wiring (mini/ maxi) stranded 6 / 25 mm²
-
- Rated currents (IEC / EN 60309-1) 60 - 63 A / 750 V (with 2 auxiliaries: 550 V)

S Socket-outlet (female)

I Inlet (male)



Main options



Padlocking shaft
(Padlock not supplied)

Accessories



IP67 Inlet cap

Voltage	Polarity	Material	Part #
20 - 24 V	2P	Polyester	25 64 08A
190 - 230 V	3P+E	Polyester	25 64 033
220 - 250 V	1P+N+E	Polyester	25 64 015
380 - 440 V	3P+E	Polyester	25 64 013
Dual voltage*	3P+N+E	Polyester	25 64 017

Voltage	Polarity	Material	Part #
20 - 24 V	2P	Polyester	25 68 08A
190 - 230 V	3P+E	Polyester	25 68 033
220 - 250 V	1P+N+E	Polyester	25 68 015
380 - 440 V	3P+E	Polyester	25 68 013
380 - 440 V	3P+N+E	Polyester	25 68 017

* See Bookmark
Other voltages, polarities: see page 8

Socket-outlet (U_{max} 550 V) with auxiliary contacts

With 2 auxiliary contacts (5A) Socket # + **972**

If you want to add an option to this kind of socket-outlet: call us at +33 (0) 1 45 11 60 00.

Socket-outlet options

Self-returning lid	Socket # + R
180°-opening lid	Socket # + 10
180°-opening and self-returning lid	Socket # + 18
Padlocking shaft for 1 padlock 3 mm Ø	Socket # + 840
Padlocking shaft up to 3 padlocks 3 mm Ø	Socket # + 844

If you want to equip a socket-outlet with two or more options: call us at +33 (0) 1 45 11 60 00.

Inlet (U_{max} 550 V) with auxiliary contacts

With 2 auxiliary contacts (5A) Inlet # + **972**

Inlet accessories

IP67 cap	25 6A 126
----------	------------------

Also see:

Dimensions page 102
Technical Manual page 150

Installation accessories

B Box



Wall box
poly 30°



Wall box
poly 70°

Entry		Tightening		Tightening
M25	25 6A B53	13 - 19 mm	25 6A B58 25P	13 - 19 mm
M32			25 6A B58	17 - 25 mm
M40			25 6A B58 40P	24 - 32 mm

Cable gland 'e' included

Sl Sleeve



Inclined
poly 30°



Inclined
poly 70°

25 6A 027	25 6A 757
------------------	------------------

H Handle



Straight poly
with poly cable gland

Entry		Tightening
M20	25 6A 253 20P	8 - 13 mm
M25	25 6A 753	13 - 19 mm
M32	25 6A 253 32P	17 - 25 mm
M40	25 6A 253 40P	24 - 32 mm

Portable stainless steel box 'ed'

Please consult us.



ZOOM DXN6 / DSN6 compatibility



The DXN6 plugs are not compatible with the DSN6 industrial socket-outlets.



DXN range dimensions

Socket-outlet + plug

Plug

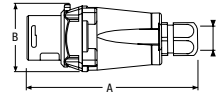

	A	B	Ø
DXN1	127	51	-
DXN3	128	68	-
DXN6	149	83	-

Socket-outlet

YB8: 180° OPENING LID

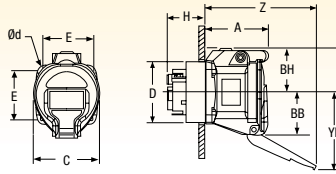

	A	BB	BH	C	D	E	H	YB	YB8	Z	ZB	Ød
DXN1	52.7	40	38	57	50.5	42	25	70	-	97.5	-	4.2
DXN3	66.2	53	50	73	58	48	15	98	-	113.6	-	4.5
DXN6	79.2	58.5	56	82	68	55.2	18	118	148	121	24.4	4.8

Plug connected (A1)/ disconnected (A0) in a socket-outlet

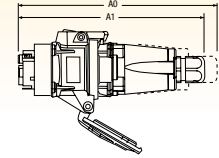

	A1	A0
DXN1	153	166
DXN3	135	169
DXN6	171	201

30° wall mounting socket

YB: 180° OPENING LID

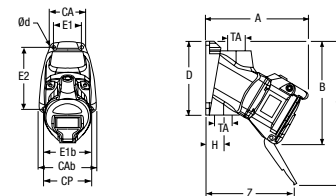

	A	B	CA	CAb	CP	D	E1	E1b	E2	H	M	Y	YB	Z	Ød
DXN1	127	131	45	68	57	90	36	56	78	37.5	16	180	-	111	4.5
DXN3	138	132	84	-	73	107	70	-	70	17.5	16	200	-	105	6
DXN6	165	162	89	-	82	122	77	-	88	24	21	236	213	114	6.5

Plug connected (A1)/ disconnected (A0) in a 30° wall mounting socket

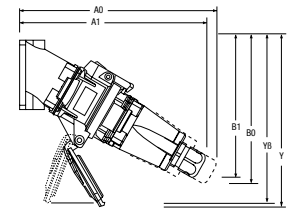

	A1	A0	B1	B0	Y	YB
DXN1	207	218	168	175	180	-
DXN3	203	218	161	169	200	-
DXN6	232	258	186	201	236	207

70° wall mounting socket

YB: 180° OPENING LID

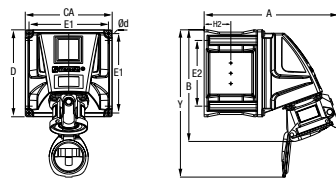

	A	B	CA	CAb	CP	D	E1	E1b	E2	H	H1	Y	YB	Z	Ød
DXN1	191	163	129	-	57	129.4	119	-	99	0	29	218	-	97	4.2
DXN3	204	174	129	-	73	129.4	119	-	99	0	29	244	-	73	4.2
DXN6	243	231	173	-	82	172.8	158	-	139	0	29	294	213	86	6.5

Plug connected (A1)/ disconnected (A0) in a 70° wall mounting socket

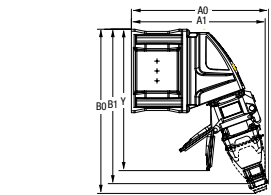

	A0	A1	B1	B0	Y	YB
DXN1	212	217	255	267	218	-
DXN3	216	221	257	273	244	-
DXN6	251	261	311	339	294	213

30° inclined socket

YB: 180° OPENING LID

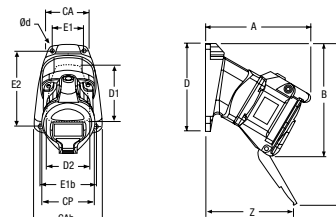

	A	B	CA	CAb	CP	D	D1	D2	E1	E1b	E2	Y	YB	Z	Ød
DXN1	108	120	45	68	57	90	75	50	36	56	78	169	-	92	4.5
DXN3	119	141	76	-	73	107	65	95	63	-	95	209	-	86	5.5
DXN6	136	156	76	-	82	107	65	95	63	-	95	230	207	85	5.5

Plug connected (A1)/ disconnected (A0) in a 30° inclined socket

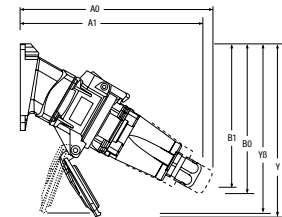

	A1	A0	B1	B0	Y	YB
DXN1	188	199	157	164	169	-
DXN3	184	199	170	178	209	-
DXN6	203	229	180	195	230	207

70° inclined socket

YB: 180° OPENING LID

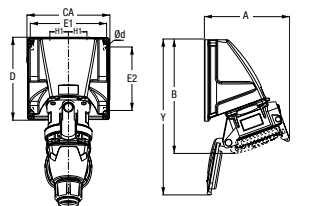

	A	B	CA	CAb	CP	D	D1	D2	E1	E1b	E2	Y	YB	Z	Ød
DXN1	122	163	129	68	57	129	94.8	114.8	119	-	99	218	-	36	4.2
DXN3	135	174	129	0	0	129	94.8	114.8	119	-	99	244	-	12	5.2
DXN6	164	231	173	0	0	172.8	132.5	151.5	158	-	139	294	213	14	6.5

Plug connected (A1)/ disconnected (A0) in a 70° inclined socket

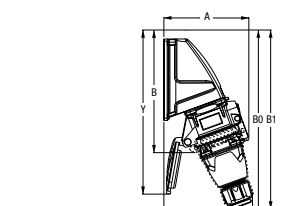

	A1	A0	B1	B0	Y	YB
DXN1	143	148	255	267	218	-
DXN3	146	152	257	273	244	-
DXN6	172	182	311	339	294	213

Coupler socket + inlet

Coupler socket

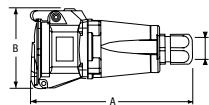

	A	B	Ø
DXN1	129	78	-
DXN3	144	103	-
DXN6	172	115	-

Inlet

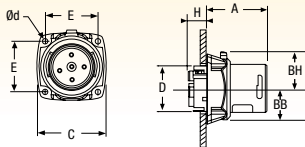

	A	BB	BH	C	D	E	H	Ød
DXN1	50.5	24	27	57	49	42	13.5	4.2
DXN3	49.6	32	36	67.7	58	48	13	4.5
DXN6	56	39	44	78	68	55.2	15	4.8

Coupler socket connected (A1)/disconnected (A0) in an inlet

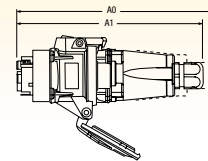

	A1	A0
DXN1	153	166
DXN3	152	169
DXN6	171	201

30° wall mounting appliance inlet

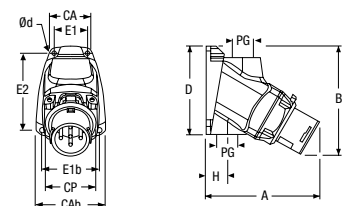

	A	B	CA	CAb	CP	D	E1	E1b	E2	H	M	Ød
DXN1	115	113	45	68	57	90	36	56	78	37.5	16	4.5
DXN3	112	105	84	-	67	107	70	-	70	17.5	16	6
DXN6	132	128	89	-	78	122	77	-	88	24	21	6.5

Coupler socket connected (A1)/disconnected (A0) in a 30° wall mounting appliance inlet

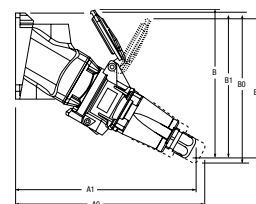

BB: 180° OPENING LID

	A1	A0	B	B1	B0	BB
DXN1	207	218	168	168	175	-
DXN3	203	218	208	153	169	-
DXN6	232	258	236	186	201	214

70° wall mounting appliance inlet

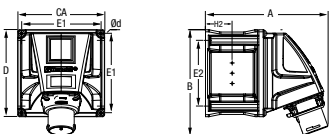

	A	B	CA	CAb	CP	D	E1	E1b	E2	H	H1	Ød
DXN1	172	156	129	-	57	129.4	119	-	99	34	29	4.2
DXN3	176	159	129	-	67	129.4	119	-	99	34	29	4.2
DXN6	211	203	173	-	78	172.8	158	-	139	34	29	6.5

Coupler socket connected (A1)/disconnected (A0) in a 70° wall mounting appliance inlet

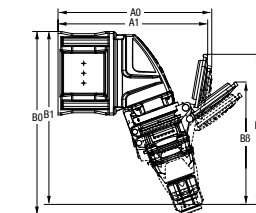

BB: 180° OPENING LID

	A1	A0	B	B1	B0	BB
DXN1	212	217	195	255	267	-
DXN3	216	221	224	257	273	-
DXN6	251	261	252	311	341	172

30° inclined appliance inlet

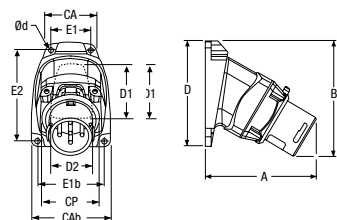

D1: drilling Ø

	A	B	CA	CAb	CP	D	D1	D2	E1	E1b	E2	Ød
DXN1	96	102	45	68	57	90	75	50	36	56	78	5
DXN3	93	114	76	-	67	107	65	95	63	-	95	6
DXN6	103	122	76	-	78	107	65	95	63	-	95	6

Coupler socket connected (A1)/disconnected (A0) in a 30° inclined appliance inlet

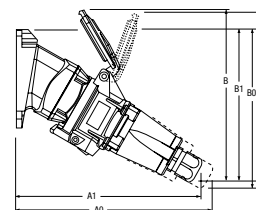

BB: 180° OPENING LID

	A1	A0	B	B1	B0	BB
DXN1	188	199	168	157	164	-
DXN3	184	199	208	170	178	-
DXN6	203	229	236	180	195	214

70° inclined appliance inlet

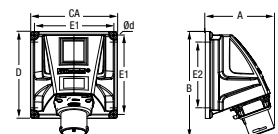

	A	B	CA	CAb	CP	D	D1	D2	E1	E1b	E2	Ød
DXN1	103	156	129	0	57	129	95	115	119	-	99	4
DXN3	107	159	129	0	67	129	95	115	119	-	99	4
DXN6	103	203	173	0	78	173	133	152	158	-	139	7

Coupler socket connected (A1)/disconnected (A0) in a 70° inclined appliance inlet

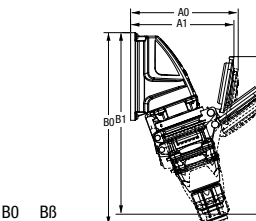

BB: 180° OPENING LID

	A1	A0	B	B1	B0	BB
DXN1	143	148	195	255	267	-
DXN3	146	152	224	257	273	-
DXN6	251	261	252	311	341	172