

Bussmann®



Handbook for Electrical Safety

Edition 2

Includes new information for calculating and reducing arc-flash hazards

 **COOPER** Bussmann

Safety BASICs™ Kits

Bussmann® offers two Safety BASICs™ Training Modules



Part # SBK Safety BASICs™ Kit for trainers.

This kit contains vital information to train personnel on electrical safety. It includes the Safety BASICs™ Handbook, video, PowerPoints, instructors guide and more.

Part #SBTH Safety BASICs™ Kit for participants.

This kit contains 10 Safety BASICs™ Handbooks, 10 participants guides, and more.

For more information, go to www.bussmann.com. The kits can be ordered from a Cooper Bussmann distributor.

NFPA Publications on Electrical Safety Order at 1-800-344-3555 or www.nfpa.org



NFPA 70E: Standard for Electrical Safety in the Workplace, 2004 Edition

The new 2004 edition of NFPA 70E: Standard for Electrical Safety in the Workplace provides the specifics for practical application of the OSHA regulations for electrical safety in general industry and construction. NFPA 70E contains updated rules on personal protective equipment and energized work permit requirements plus much more. Order today!

NFPA 70E: Electrical Safety in the Workplace, 2004 Edition

Item No. S6-70E04 \$38.25 (Members: \$34.43)



The Electrical Safety Program Book

The book provides a basis to set up an electrical safety program including a site assessment and checklist to identify hazardous and non-hazardous tasks at the site. Include a Sample Electrical Safety Program, guidance for the selection of personal protective equipment and much more. Auditing and record keeping requirements, budgeting, and administration guidelines round out this complete package, plus forms and checklists on CD-ROM.

This book is authored by Ray Jones, the Chairman of the NFPA 70E committee and Ken Mastrullo, the NFPA Staff Liaison for NFPA 70E, and edited by Jane Jones.

NFPA ESM03: The Electrical Safety Program Book Item No. S6-ESM03 \$79.95 (Members: \$71.96)

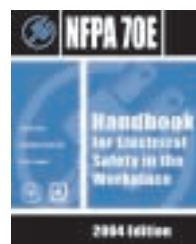

The NFPA 70E: Handbook for Electrical Safety in the Workplace, 2004 Edition

The premiere edition of the NFPA 70E Handbook includes the entire text of the 2004 NFPA 70E Standard plus commentary and explanations to further clarify tough concepts and provisions. Tables, illustrations, and diagrams enhance comprehension, enabling you to comply and meet requirements with confidence.

NFPA 70EHB04: Electrical Safety in the Workplace Handbook, 2004 Edition

Safety BASICS™

Handbook for Electrical Safety

(Bussmann® Awareness of Safety Issues Campaign)

Edition 2

This is an unproven compilation of technical materials that has been assembled by the developers for the benefit of training others about electrical safety, including electrical arc-flash hazards. It is being presented to illustrate the critical nature of electrical safety practices. While not the only method(s) or answer(s), or perhaps not even the best method(s) or answer(s), in the opinion of the developers/presenters the content is an accurate, acceptable, and positive way to present the subject material. The National Fire Protection Association's *NFPA 70E, Standard for Electrical Safety in the Workplace*, introduces safe work practices to mitigate the hazards identified by this work. By creating awareness of the potential hazards and describing workable solutions by which the hazards can be controlled, minimized or eliminated, it is hoped that injury will be reduced and lives will be saved.

Use of the information contained in the Safety BASICS™ program material is at your own risk.

Those seeking permission to reproduce portions of this document must contact Cooper Bussmann, Inc. for appropriate license.



Table of Contents

I.	Introduction	7			
II.	Consensus Standards	7			
	A. Types of standards	8			
	B. <i>NFPA 70 (National Electrical Code®)</i>	8			
	C. OSHA standards	8			
	D. <i>NFPA 70E</i>	9			
	E. OSHA and <i>NFPA 70E</i>	9			
	F. Other standards and resources.....	10			
III.	Establishing an Electrical Safety Program	11			
IV.	Electrical Safety Program	11			
	A. Safety program principles	11			
	B. Safety program controls	12			
	C. Safety program procedures.....	13			
	D. Hazard/Risk evaluation	13			
	E. Job briefing	13			
	F. Incident and injury prevention	13			
	G. Designing electrical system for safety	14			
V.	Electrical Hazards	14			
	A. Electrical shock	14			
	B. Arcing faults: arc-flash and arc-blast.....	16			
	1. Arc fault basics	16			
	2. Arc-flash and arc-blast	17			
	3. Effects on humans	17			
VI.	The Role of Overcurrent Protective Devices In Electrical Safety	18			
	- Staged arc-flash tests	19			
VII.	Attending to Electrical Incident Victims	21			
	A. Preparedness	21			
	B. Effects of electrical incidents.....	21			
	C. Enhancement of chances for recovery	21			
VIII.	Who's Responsible for Safety?	22			
IX.	Electrical Incident and Hazard Prevention	23			
	A. Not working on or near	23			
	B. Electrically safe work condition	23			
	C. Shock hazard and flash hazard analysis	24			
	D. Approach boundaries for shock protection	25			
	E. Flash hazard analysis	27			
	Method 1: NFPA 70E tables	27			
	Method 2 NFPA 70E formulae	28			
	Method 3 IEEE 1584	29			
	Example 1: method 1	30			
	Example 2: method 2	31			
	Example 3: method 3	33			
	Arcing fault currents in the long time characteristic of overcurrent protective devices	34			
	Other considerations	34			
	F. Personal protective equipment (PPE)	35			
	G. Lockout/Tagout	37			
	H. Stored energy systems	38			
	I. IP2X (finger-safe) ratings	38			
	J. Grounding and GFCIs	39			
	K. Voltage testing 1,000V and below.....	40			
X.	Suggestions for Limiting Arc-flash and Shock Hazards	42			
	A. Avoidance is surest safety measure	42			
	B. Avoidance: Energized Work Permit	42			
	C. Voltage testing work practices & PPE.....	43			
	D. NEC® 110.16 arc-flash warning label	43			
	E. Worker qualified for the task	44			
	F. Resetting circuit breakers or replacing fuses	44			
	G. Follow procedures for fuses and circuit breakers after interrupting a fault	44			
	H. Testing fuses	45			
	I. Properly test knife-blade fuses	45			
	J. Good housekeeping	46			
	K. Keep equipment doors closed.....	46			
	L. Keep people outside the flash protection boundary.....	46			
	M. Overcurrent protection reliability, maintenance requirements, and the effect maintenance has on arc-flash hazards.....	46			
	N. Designing systems overcurrent protective device selection	47			
	1. Non current-limiting	47			
	2. Current-limiting	48			
	O. Specify switches that shunt-trip when a fuse opens	49			



Table of Contents

P. Improving existing fusible systems that have Class H, R, J, CC, or L fuse clips, upgrade to LOW-PEAK® fuses	49	CC. Retrofit existing feeders with LOW-PEAK® fuses	54
Q. Type 2 (“no damage”) protection for motor controllers	50	DD. Retrofit under-utilized circuits with lower-amp rated LOW-PEAK® fuses	54
R. Finger-safe products and terminal covers	51	EE. Proper interrupting rating	55
S. In-sight motor disconnects	51	XI. Costs Associated with Safety	56
T. Isolate the circuit: selective coordination ..	52	XII. References	57
U. High impedance-grounded wye systems ..	52	XIII. Glossary of Terms	57
V. Do not use short-time delay settings on circuit breakers	52	Notes Pages	59-60
W. Specify a main on a service	53	XIV. Annexes	
X. Cable limiters on service conductors	53	A. Checklist for victims of electrical incidents	61
Y. Break up large loads into smaller circuits	53	B. Sources of information	62
Z. If using circuit breakers, specify zone-selective interlocking	54	C. OSHA & other standards for protective equipment	63
AA. “Smart” equipment	54	D. Listing of IEEE standards: color books	64
BB. Utilize arc resistant MV switchgear	54	E. Safety BASICS™—awareness quiz	65
		F. 3Ø Short-circuit calculation method	67
		G. Arc-flash incident energy & FPB calculator table & notes	69
		LOW-PEAK® Upgrade	back-cover



Acknowledgement

Special thanks go to Ray A. Jones, PE, and Jane G. Jones, with Electrical Safety Consulting Services, Inc., (ESCS, Inc.), who provided consultation services for the Safety BASICs program material.

Ray is a professional engineer with more than 40 years of experience in developing and operating electrical safety systems and processes in industrial units. Ray retired from the DuPont Company in 1998, where he held the position of Principal Consultant, concentrating on electrical safety systems and processes as well as codes and standards. Ray chairs the technical committee for *NFPA 70E, Standard for Electrical Safety in the Workplace*. He is a senior member of the Institute of Electrical and Electronic Engineers (IEEE).

Ray has authored or co-authored many technical papers covering safety systems and processes, several of which have been published in *IEEE Transactions on Industry Applications*, and earned awards from IEEE. He is a frequent lecturer and contributor at the IEEE-IAS Petroleum and Chemical Industry Committee Electrical Safety Workshop and other IEEE tutorials.

Jane has worked as a book and journal editor, newspaper reporter, author, and technical writer. In addition to serving as a writing consultant and editor for many technical papers, she has coauthored and edited numerous technical journal articles. Specializing in electrical safety, Jane helps to develop and formulate procedures and standards for industrial plants.

Ray and Jane wrote the book *Electrical Safety in the Workplace*, published by NFPA in 2000, and coauthored *The Electrical Safety Program Book* with Ken Mastrullo in 2003.

To learn more about services offered by ESCS, Inc., contact Ray Jones at 919-557-7711, ray.jones@ieee.org, or jandrjones@worldnet.att.net.



Safety BASICs™ - Bussmann Awareness of Safety Issues Campaign
Copyright ©2004 Cooper Bussmann
All Rights Reserved
Printed in the U.S.A

I. Introduction

An increasing number of organizations are actively promoting electrical safety for employees. The National Fire Protection Association's *NFPA 70E, Standard for Electrical Safety in the Workplace*, an American National Standard, is updated on a three-year cycle. The Institute of Electrical and Electronics Engineers (IEEE) publishes the Yellow Book, the *IEEE Guide for Maintenance, Operation, and Safety of Industrial and Commercial Power Systems*, and IEEE 1584™, the "IEEE Guide for Performing Arc-flash Hazard Calculations." Cooper Bussmann makes available an "Arc-flash Calculator Guide," see Annex G and an arc-flash calculator on its website (www.bussmann.com). The University of Chicago Trauma Center has a unit that specializes in electrical burns and related injuries. Its interests are not only on improving treatment methods but also in providing insight into electrical injuries and awareness of how to avoid electrical hazards. Major manufacturers and entire industries are seeing benefits of becoming more involved in promoting employee safety awareness programs.

The purpose of this Safety BASICs™ handbook is to do the following:

- Increase awareness of safety issues for individuals who work on or near electrical equipment as well as system operators and equipment designers/specifiers.
- Provide safety principles to be used for protecting individuals from potential injuries and even death caused by electrical hazards.
- Provide some means to perform flash hazard analysis.
- Provide some design, system upgrades and work practice suggestions that enhance electrical safety in the workplace.

This material is designed to provide the reader with an overview of hazards associated with exposure to electrical energy. It highlights standards and standard organizations, and offers guidance on safety procedures and a number of key principles that can help to minimize exposure to electrical hazards. Knowing how to minimize the exposure to electrical hazards or reducing the hazard itself can help to reduce future injuries and even deaths.

The Safety BASICs program is for the supervisor, manager, electrician, engineer, and the designer/specifier of equipment used in the electrical system. The IEEE makes it very clear that, "Engineers engaged in the design and operation of electrical systems protection should familiarize themselves with the most recent OSHA regulations and all other applicable regulations related to human safety." To the IEEE, providing adequate safety means going beyond the minimum requirements of consensus standards.

Perhaps a statement in the IEEE "Buff Book" says it best: "**Safety has priority over** service continuity, equipment damage or economics."

II. Consensus Standards

Consensus standards are seen as generally accepted engineering practices and can be used for litigation purposes when entered as evidence in a legal proceeding. In case of an incident where litigation is involved, the design and safety practices used are compared with these standards. In some cases, this type of enforcement is more critical than if the government were the enforcing agent.

In the United States, consensus standards are normally written by volunteers and published by standards-developing organizations (SDOs). The content of consensus standards is the result of work done by a blue-ribbon panel of experts and defines the industry's best generally available knowledge. Consensus standards fall into several different classes. Some consensus standards are product oriented; others define testing requirements, cover installation or design issues, or are people oriented. Many become legally mandated by governmental organizations.

Whether a national consensus standard is mandated and enforced by governmental action or not, the judicial system tends to use these standards as generally recognized and accepted engineering practices for litigation purposes. To understand the significance of this point, consider the text used in the OSH Act: "the (Labor) Secretary shall...by rule promulgate as an occupational safety or health standard any national consensus standard..." The legal profession uses relevant national consensus standards in court cases, where the standard is entered into evidence.

Each SDO and standard has a principle objective. To correctly apply any individual consensus standard, both the SDO objective and the standard objective should be clearly understood. The standard then should be applied with this understanding in mind. For instance, the National Fire Protection Association (NFPA) is primarily concerned with fire protection and personal safety. Therefore, NFPA standards should be embraced when these objectives are considered important. Some NFPA standards are product oriented; others are installation oriented. These standards should be applied as discussed in the scope of the document.

The NFPA publishes two critical standards. One is *NFPA 70*, otherwise known as the *National Electrical Code® (NEC®)*, and the other is the *Standard for Electrical Safety in the Workplace (NFPA 70E)*. The NFPA has many other standards, but these are two of the most important electrical standards.



The premier standards publishing organization in the U.S. is the American National Standards Institute (ANSI). ANSI is authorized by the U.S. government as the organization with the authority to identify American National Standards (ANS). No standard is written by ANSI; instead, ANSI identifies requirements for both the SDO and the standard. Among these is a requirement that each standard be produced by people knowledgeable in the area being addressed. Each ANSI standard, then, is ensured to have had broad, knowledgeable input as well as a “consensus” by the community covered by the standard.

Most consensus standards define minimum requirements necessary to accomplish the prime objective under normal operating or functioning conditions. Of course, in most cases, a standard tends to define some protective measures. However, defined protective measures are intended to protect the equipment from destruction in case of a failure. Generally, consideration for the “people factor” is missing from the standards puzzle, even though actions of people account for more than 75 percent of all incidents that result in injury.

A. Types of standards

At this point in time, more than 22,000 national consensus standards exist in the U.S. Standards developing organizations (SDOs) that address electrical safety include the:

- American National Standards Institute (ANSI)
- National Fire Protection Association (NFPA)
- Institute of Electrical and Electronic Engineers (IEEE)
- Underwriters Laboratories (UL)
- U.S. Occupational Safety and Health Administration (OSHA)
- National Electrical Contractors Association (NECA)
- National Electrical Manufacturers Association (NEMA)

Note that these SDOs mostly are based in the U.S. and primarily have a U.S. focus.

Each of these SDOs writes and publishes standards that address various electrical safety issues. As stated earlier, some standards are intended for adoption by governmental organizations. However, national SDO-developed consensus standards not adopted by governmental organizations can still be used in a court of law.

B. NFPA 70 (the National Electrical Code® — NEC®)

NFPA 70 commonly is called the *National Electrical Code*, or the *NEC*. The *NEC* is currently adopted by more than 1,800 different governmental organizations in the U.S. and by several Latin American countries. These organizations include city, county, or state governments. Some adopt the *NEC* as it is published by NFPA; others add or subtract requirements.

The *NEC* is the document related to installation of “premises” wiring. Premises wiring involves interior and exterior wiring, including power, lighting, control and signal circuits, along with all associated hardware. This wiring extends from the service point from the utility or separately derived system to the outlet(s).

The focus of the *NEC* is to identify requirements used to control the probability of electrical fires and provide safe installation when the system or equipment is operating normally. By itself, the *NEC* is a standard with advisory information offered for use in law and for regulatory purposes. The *NEC* is reviewed and revised on a three-year cycle.

Keep in mind, however, that the *NEC* is offered as a “minimum” standard and, therefore, its requirements sometimes must be exceeded to meet functional necessities, sound engineering judgment, and improved safety.

C. OSHA standards

The U.S. Occupational Safety and Health Administration was authorized by the Williams-Steiger act of 1970. The OSHA Act passed both Houses of Congress. Signed into public law, it became known as “The Act.” The Act provides for several very important elements:

- Establishes OSHA as an arm of the U.S. Department of Labor
- Mandates that an employer provide a safe workplace for employees
- Defines national consensus standards as the starting point for a safe workplace
- Provides for an inspection and enforcement process
- Provides for a due process
- Provides for specific standards related to personal safety requirements
- Provides for public input to the process

OSHA standards are published in the U.S. Federal Register and made available to the general public online at www.osha.gov and in hard copy from the U.S. Government Printing Office.



The U.S. Department of Labor has written the OSHA regulations under Title 29 of the Code of Federal Regulations (CFR), establishing them as requirements for electrical installations and electrically safe practices. In the Standard 29 CFR, Part 1910 covers general industry, while Part 1926 covers the construction industry (see Table II(C)). Each Part is subdivided into Subparts. Each Subpart is further subdivided into Paragraphs.

Table II(C). OSHA Standards for Electrical Work

OSHA Standard	Title	Addresses
1910.7	Nationally Recognized Testing Laboratories	NRTLs
1910.137	Electrical Personal Protective Equipment	Voltage-rated protective products
1910.147 1910.333(b)(2)	Control of Hazardous Energy	Lockout/tagout
1910.269	Power Generation, Transmission and Distribution	Overhead and underground distribution
1910.300-399	Electrical Safety Requirements	General industry
1926.400-449	Electrical Safety Requirements	Construction

General industry tasks (for electrical energy) are covered in 29 CFR 1910.7, 1910.137, 1910.147, 1910.269, and 1910.300-399. Construction tasks are located in section 1926.400-449. OSHA standards (rules) and requirements also contain definitions. These definitions generally are related to tasks rather than employers or even industries. Employers should therefore pay close attention to the type of tasks being performed.

It is important to note that OSHA law enforcement includes fines. While many fines may be small, it is not unusual for fines of up to \$70,000 to be assessed per instance, per exposed employee. OSHA fines easily can escalate to more than a million dollars. In addition to fines, OSHA violations can result in criminal indictment. It is also becoming more common for an employer to be held personally accountable. In some situations, the employer, or even the plant manager, can be held criminally liable and sent to jail.

D. NFPA 70E

NFPA 70E is the *Standard for Electrical Safety Requirements in the Workplace*. This standard focuses on protecting people and identifies requirements that are considered necessary to provide a workplace that is generally free from electrical hazards. *NFPA 70E* is intended to address conditions that exist, or might exist, and abnormal conditions where people can become involved.

NFPA 70E suggests the following:

- Electrical hazards include shock, arc-flash, and arc-blast.
- The best way to avoid injury or incident is to establish an electrically safe work condition before beginning the work.
- Procedures and training are extremely important if injury is to be avoided.

When OSHA's electrical standards were first developed, they were based on the *National Electrical Code*. As OSHA focused more on all aspects of electrical safety, OSHA recognized the need for a consensus document of electrical safety requirements to protect individuals working on, or near, electrical equipment.

The first edition of *NFPA 70E* was published in 1979. Although *NFPA 70E* may not yet have the same extensive recognition as the *NEC*, it provides the latest thinking on the subject of electrical safety, particularly in the area of safe work practices. Many parts of the current OSHA regulations 29 CFR 1910 Subpart S were derived from *NFPA 70E*.

NFPA 70E identifies the requirements for enhanced personal safety. It is growing in recognition as an extremely important national consensus standard that defines the requirements for an overall electrical safety program. It is being adopted widely by organizations across the U.S. National consensus standards, like *NFPA 70E*, may be entered into evidence in a court of law.

E. OSHA and NFPA 70E

For electrical safety in the workplace, some people describe the relationship between the OSHA regulations and *NFPA 70E* as OSHA is the "shall" and *NFPA 70E* is the "how." OSHA regulations, which are Federal law and shall be followed, are often written in performance-oriented language (does not state how to comply). *NFPA 70E* is recognized as the tool that illustrates how an employer might accomplish the objective defined by the OSHA performance-oriented language.

For electrical citations, OSHA commonly uses the general duty clause and then as an alternative (means to comply) OSHA uses *NFPA 70E*.

General Duty Clause: Section 5(a)(1) of the Occupational Safety and Health Act requires an employer to furnish to its employees: "employment and a place of employment which are free from recognized hazards that are causing or are likely to cause death or serious physical harm to his employees ..."



The following is an excerpt from an OSHA Letter of Interpretation dated July 25, 2003 signed by Russell B. Swanson, Director, Directorate of Construction:

Industry Consensus Standard NFPA 70E

With respect to the General Duty Clause, industry consensus standards may be evidence that a hazard is "recognized" and that there is a feasible means of correcting such a hazard. ...

Industry consensus standards, such as NFPA 70E, can be used by employers as guides to making the assessments and equipment selections required by the standard. Similarly, in OSHA enforcement actions, they can be used as evidence of whether the employer acted reasonably.

The following is another excerpt from the OSHA Letter of Interpretation dated July 25, 2003 signed by Russell B. Swanson, Director, Directorate of Construction:

Question (2): *I note that OSHA has not incorporated the personal protective equipment portions of NFPA 70E by reference in §1910.132 (personal protective equipment, general requirements) or §1910.335 (safeguards for personal protection). Does an employer have an obligation under the General Duty Clause to ensure that its own employees comply with personal protective equipment requirements in NFPA 70E?*

Answer (partially reprinted)

These provisions are written in general terms, requiring, for example, that personal protective equipment be provided "where necessary by reason of hazards..." (§1910.132(a)), and requiring the employer to select equipment "that will protect the affected employee from the hazards..." (§1910.132(d)(1)). Also, §1910.132(c) requires the equipment to "be of safe design and construction for the work performed."

Similarly, §1910.335 contains requirements such as the provision and use of electrical protective equipment that is appropriate for the specific parts of the body to be protected and the work to be performed (§1910.335(a)(i)).

Industry consensus standards, such as NFPA 70E, can be used by employers as guides to making the assessments and equipment selections required by the standard. Similarly, in OSHA enforcement actions, they can be used as evidence of whether the employer acted reasonably.

Another approach by OSHA is to investigate whether electrical work meets 1910.333(a)(1) which requires workers not to work on or near exposed live parts except for two demonstrable reasons (see Section IX (A) in this book). If the work can be justified for a worker to work on or near while energized, then OSHA will use *NFPA 70E* as an alternative or means to comply. That is OSHA uses *NFPA 70E* as the "how."

Brotherhood of Electrical Workers (IBEW) Locals 683 and 1105 and with OSHA Region V Columbus Area Office have an agreement to work as partners to achieve improvements in electrical worker safety. As part of the agreement there is a standard checklist that must be used when working energized circuits; this is based on *NFPA 70E*.

In 2000, a major industrial was cited by OSHA for alleged serious and repeated safety violations including "failing to de-energize live electrical parts before working on or near them," "failing to require employees to wear protective clothing, gloves, and face protection when working on or near electrical parts," and "failing to certify that a hazard assessment had been conducted." In the settlement between the company and OSHA, it was agreed the company develop hazard analyses in accordance with specific *NFPA 70E* requirements.

F. Other standards and resources

The *National Electrical Safety Code (NESC)* is an ANSI standard that is written and published by the IEEE. This standard is intended to identify requirements that apply to outdoor electrical transmission, distribution, and communication systems, equipment, and associated work practices, as opposed to premises wiring, which is addressed in the *NEC*. The *NESC* is the base standard that provided the starting point for OSHA when 29 CFR 1910.269 was being written.

NFPA 70B, Recommended Practices for Electrical Equipment Maintenance, is a document whose purpose is to reduce hazards to life and property that can result from failure or malfunction of industrial and commercial electrical systems and equipment. Along with its maintenance guidance, it also addresses electrical safety.

The National Electrical Manufacturers Association (NEMA) has many standards on electrical products and systems. NEMA standards often have served as a basis for Underwriter Laboratories® (UL) safety standards. Both NEMA and UL standards are designed as consensus standards and are considered as minimal requirements.

The Color Book Series by the Institute of Electrical and Electronic Engineers (IEEE) provides recommended practices and guidelines that go beyond the minimum requirements of the *NEC*, *NEMA*, and *UL* standards. When designing electrical power systems for industrial and commercial facilities, consideration should be given to the design and safety requirements of the IEEE color books listed in Annex D.

The need for unified international standards was identified many years ago. The U.S. standards system is essentially voluntary. In some parts of the world, governments essentially mandate adherence to the



As an example of progressive safety initiatives, the National Electrical Contractors Association (NECA) Central Ohio Chapter in partnership with the International

standards system that is in place. The International Electrotechnical Commission (IEC) standards are an attempt within international communities to reach a consensus on standard requirements. Significant progress is being achieved with this objective. Many of the European governments have mandated standards systems. The European Union (EU) encourages further consensus among affected nations.

In many instances, protection schemes embraced in the IEC differ from those in the U.S. For example, in the U.S., nationally recognized testing laboratories are used to perform standardized “third party” product testing. Products meeting the testing standard are marked, identifying the testing laboratory. Many products meeting international safety requirements for installation in Europe require certification to testing standards and must bear a CE mark. The CE mark applies to certain “directives” within European Union countries. The intent is to provide a “safe” product that is acceptable to all of the EU countries.

With regard to personnel safety, the IEC standards address protection from electrical shock more directly than U.S. standards. For instance, IEC standards generally recognize that degrees of exposure vary. This idea will be discussed further in the section on IP finger-safe ratings.

III. Establishing an Electrical Safety Program

Reducing and even eliminating exposure to electrical hazards requires continuous attention. An overall electrical safety program must be implemented that emphasizes specific areas of concern. The program must be well thought out. People who are well versed in safety standards and procedures must write the program. Program authors should include safety professionals, technical professionals, and practitioners. And the program must be published and readily available to all employees. The following are three good reasons for practicing electrical safety:

- Personal reasons, which affect us as caring individuals and employers
- Business reasons, because safety makes good business sense
- Regulatory and legal reasons, because violations can result in fines and/or imprisonment

An essential element in an effective electrical safety program is training. From both a legal and effective point of view, training records are important. Training should be based on the program and procedures in place within an organization. The training should focus first on increasing knowledge and understanding of electrical hazards and second on how to avoid exposure to these hazards. As a person completes a spe-

cific segment of training, a record should be established and maintained.

An electrical safety program should accomplish the following objectives:

- Make personnel aware of the rules, responsibilities, and procedures for working safely in an electrical environment.
- Demonstrate the employer’s intention to comply fully with federal law.
- Document general requirements and guidelines to provide workplace facilities free from unauthorized exposure to electrical hazards.
- Document general requirements and guidelines to direct the activities of personnel, who could be either deliberately or accidentally exposed to electrical hazards.
- Encourage and make it easier for each employee to be responsible for his or her own electrical safety self-discipline.

IV. Electrical Safety Program

An electrical safety program is vital in establishing an electrically safe work place and is required:

NFPA 70E 110.7 Electrical Safety Program.

(A) General. The employer shall implement an overall electrical safety program that directs activity appropriate for the voltage, energy level, and circuit conditions.

FPN: Safety-related work practices are just one component of an overall electrical safety program.

To reduce electrical hazards, each hazard must be addressed, as the work is being assigned and planned. An overview of electrical safety requirements can be found in OSHA 29 CFR 1910.331—1910.335, “Safety-Related Work Practices.” These requirements contain information on qualified vs. unqualified persons, training requirements, work practice selection, use of electrical equipment, and safeguards for personnel protection. In addition, *NFPA 70E* addresses all the key aspects of electrical safety and electrical safe work practices. If these requirements are followed completely, injuries and deaths can be prevented.

A. Electrical safety program principles

The following principles, when implemented, can help ensure safer work places:

1. **Identify and minimize the hazards in electrical systems.** For new systems, designers should address minimizing hazards in the electrical system design stage. For existing systems, implement upgrades or retrofits that reduce the hazards.



2. **Plan every job.** Most incidents occur when something unexpected happens. Take time to prepare a plan that considers all possible eventualities. Before you start the job, think about each step and try to visualize the potential for a hazard. If needed, conduct a flash hazard and shock hazard analysis; *NFPA 70E* 110.8(B)(1)(a) & (b) have requirements for these analyses.
3. **If possible, put circuit or equipment in an electrically safe work condition.** An *electrically safe work condition* is an important principle. If the industry only worked on equipment or circuits that are in an electrically safe work condition, there would be far fewer injuries and deaths of an electrical origin. For more on electrically safe work condition, refer to Electrical Incident and Hazard Prevention Section.
4. **Anticipate unexpected results.** When thinking about a job, break each task into small steps. Understand that plans can change, so be ready to modify the plan if necessary. Make sure that everyone involved in the job is working according to the same plan. Whenever work is required near an electrical hazard, a written plan is needed to outline the scope of the job.
5. **Identify and minimize the hazards for each job.** After your work plan is complete, review each step. Consider that the equipment might be perfectly safe under normal conditions and very unsafe when systems are not working properly. Also consider potential hazards that might be unrelated to electrical energy. If it is impossible to establish an electrically safe work condition, be sure to shut down every possible energy source. Understand that sometimes a de-energized circuit can become re-energized, and do something to lessen the risk.
6. **Assess a worker's abilities.** Make sure that any person assigned to tasks associated with electrical energy is qualified and trained for the job at hand. He or she must be able to identify electrical hazards, avoid exposure to those hazards, and understand the potential results of all action taken. Don't forget to include yourself in this analysis. And don't forget to establish and maintain training records.
7. **Use the right tool for the job.** Use the appropriate tools for the job at hand, keeping them accessible and in good working condition. Using a screwdriver for a job that requires a fuse puller is an invitation to an incident. Unless the component is listed for the purpose, fuses must never be installed or removed when the circuit is energized.
8. **Isolate the equipment.** The best way to avoid an incident is to reduce exposure to hazards. Keep doors closed. Keep barricades in place. Install temporary voltage-rated blankets covering exposed live parts.
9. **Protect the person.** Use appropriate PPE for the job. This equipment might include safety glasses or face shield, head protection, voltage-rated gloves, safety belts and harness, or flame-resistant clothing.
10. **Inspect/evaluate the electrical equipment.** Be sure the equipment is suitable for its use, where it is applied, and in good working condition.
11. **Maintain the electrical equipment's insulation and enclosure integrity.** As an example, if repairs or changes must be made, use components meeting the original specifications.
12. **Audit these principles.** A principle is something you believe in enough to be willing to do. Are you willing to take the steps necessary to avoid injury? Review these principles often. Add to them when necessary.

B. Electrical safety program controls

Controls can ensure the electrical safety program is implemented properly. Some controls include the following:

1. Implement an ***Energized Work Permit*** procedure and culture.
2. **All conductors or equipment are considered energized** until verified otherwise.
3. **No "bare-hand" work** on exposed conductors or circuits above 50V to ground that have not been placed in an electrically safe work condition, unless the "bare-hand" method is necessary and properly used.
4. **The tasks while de-energizing and putting a conductor or circuit in an electrically safe work condition are in themselves hazardous.** Take proper precautions and wear the appropriate PPE while putting circuits in an electrically safe work condition.
5. **Responsibilities:** employers develop programs and training, and the employees apply them.
6. **Use procedures as tools.** Procedures are the best way to help you prepare, execute, and complete the job. Like any tools, make sure your procedures are maintained.
7. **Train employees to qualify them** for working in an environment influenced by the presence of electrical energy.
8. **Hazard determination:** use a logical approach to determine the potential hazards associated with doing tasks.
9. **Precautions:** identify and use precautions appropriate to the working environment.



C. Electrical safety program procedures

All electrical work should be planned before the work begins, and the work should be done to approved procedures that comply with safe work practices. For non-hazardous electrical work, the plan is typically unwritten. Jobs that are done repeatedly should have a written procedure, which is followed each time the work is performed. Written or not, all plans must consider all hazards and guard against them. A qualified person who understands the work to be done and hazards involved as well as is familiar with the equipment being worked on, should prepare written procedures. Written procedures must include a step-by-step outline of the work to be performed and a single-line diagram or other appropriate drawings that can be used to discuss the job. Procedures for work performed should be reviewed with the appropriate individuals responsible.

Procedures typically come in two varieties: those written specifically to plan a particular job or more general procedures that include a checklist or a simple verbal plan. Procedures can include:

- Purpose of task
- Number of workers and their qualifications
- Hazardous nature and extent of task
- Shock approach boundaries and flash protection boundaries
- Safe work practices to be utilized
- Personal protective equipment required
- Insulating materials and tools required
- Special precautionary techniques
- Electrical diagrams and one-line diagrams
- Equipment details
- Sketches of unique features
- Reference data

D. Hazard risk evaluation

Every electrical safety program must include a procedure for analyzing the risks and hazards associated with each job. This analysis must include an evaluation of hazards, work procedures, special precautions, energy source controls, and PPE requirements. If the work tasks include working on or near exposed electrical parts that have not been put in an electrically safe work condition, then 70E-110.8(B)(1) requires an electrical hazard analysis. This includes a shock hazard analysis and flash hazard analysis. If necessary, these analyses will determine the appropriate shock approach boundaries, flash protection boundaries, personal protective equipment, and tools required for specific tasks. The analyses should be documented and retained.

The hazard/risk analysis can only be performed after the task planning process is complete. In concept, each step of a task should be analyzed in accordance with a defined protocol. Each step of the protocol should take a step closer to understanding if a risk is associated with the task. In performing a hazard/risk analysis, analyzing the exposure to electrical hazards must be the main focus.

Identifying the necessary PPE is also important to protect the person should there be an accidental release of energy. For instance, the first step should be to determine if the equipment or service must remain energized while the task is executed. When the questions are answered, the task is defined in terms of the amount of voltage and energy available in the system while the work is executed.

Note: *The preferred work practice is to establish an electrically safe work condition prior to executing the task. PPE is necessary until the electrically safe work condition is established.*

NFPA 70E has a sample risk/hazard analysis flow diagram in Annex G.

E. Job briefing

NFPA 70E 110.7(G) requires that prior to the start of a job the involved workers shall be briefed on such topics as hazards associated with the job, work procedures, special precautions, energy source controls, and PPE required. If the day's work is repetitive or similar, a job briefing shall be conducted prior to the first job of the day. Contractors typically do a tailgate briefing at the beginning of the day. During the course of the day's work, if there are significant changes, additional briefing(s) shall be conducted. If the work is routine, then the briefing can be short. A more in-depth briefing is required if the work is complicated, hazardous, or the workers cannot be expected to recognize the hazards involved. See *NFPA 70E* Annex I, Job Briefing and Planning Checklist.

F. Incident and injury prevention

The following actions should be undertaken in every electrical safety program:

- Review programs for the inspection and/or repair of portable electrical equipment for completeness and effectiveness.
- Review policies concerning work permits on energized circuits with a goal of reducing the frequency of such work.
- Emphasize electrical worker training in the following areas:
 - Lockout/tagout practices
 - Use of protective equipment



- Use of insulated tools
- Minimum approach distances
- Meter selection/testing/use
- Electrical rescue/CPR
- Include a pre-task review of the following for supervision of selected electrical work:
 - Goals of the task
 - Task methodology (energized vs. lockout/tagout)
 - Qualifications of assigned personnel — proper instrumentation/tools
 - Adequate protective equipment and usage
 - Methods of preventing a fall should a shock occur
- Perform an inventory of energized electrical circuits with a goal of disconnecting unused circuits from the source and removing the wiring.

Employees must be provided training that includes information about electrical risks, such as inadequate grounding, reverse polarity, and probable electric shock-producing equipment, including extension cords, plugs, and portable power tools. The dangers of energized and unattended appliances should be stressed in this training as well as the theory behind lockout and tagout procedures. Employees working with electricity must also be informed on how to recognize electric shock victims, safe methods of rescue, and cardiopulmonary resuscitation.

G. Designing an electrical system for safety

It is advisable that the electrical safety program includes a process to consider improvements to existing electrical systems and better designs for worker safety for new systems. There are numerous electrical system and equipment design considerations that can improve safety for workers. Some ideas for system design and system upgrades are presented in Suggestions for Limiting the Arc-flash and Shock Hazards, Section X.

V. Electrical Hazards

Electricity has become such an integral part of our society that it often is taken for granted. Yet, electricity remains a very dangerous hazard for people working on or near it. Many electrical circuits do not directly pose serious shock or burn hazards by themselves. However, many of these circuits are found adjacent to circuits with potentially lethal levels of energy. Even a minor shock can cause a worker to rebound into a lethal circuit or cause the worker to drop a tool into the circuit.

Involuntary reaction to a shock might also result in bruises, bone fractures, and even death from collisions or falls.

The following are recognized as common electrical hazards that can cause injury, and

even death, while a person works on or near electrical equipment and systems:

- Electrical shock
- Electrical burns from contact (current) and flash (radiant)
- Arc-blast impact from expanding air and vaporized materials

In the next several sections, electrical shock, arc-flash, and arc-blast will be discussed in more depth. In addition, a section on the term “electrically safe work condition” explains the steps necessary to achieve this condition. *NFPA 70E* 110.8(B)(1) requires an electrical hazard analysis if workers will be exposed to electrical parts that have not been placed in an electrically safe work condition. This shall include a Shock Hazard Analysis and Flash Hazard Analysis, which will also be covered in other sections.

OSHA 1910 Subpart S - 1910.333(a)

Safety-related work practices shall be employed to prevent electric shock or other injuries resulting from either direct or indirect electrical contacts, when work is performed near or on equipment or circuits which are or may be energized. The specific safety-related work practices shall be consistent with the nature and extent of the associated electrical hazards...

A. Electrical shock

More than 30,000 non-fatal electrical shock incidents are estimated to occur each year. The National Safety Council estimates that from 600 to 1,000 people die every year from electrocution. Of those killed with voltages less than 600V, nearly half were working on exposed energized circuits at the time the fatal injury occurred. Electrocution continues to rank as the fourth highest cause of industrial fatalities (behind traffic, violence/homicide, and construction incidents).

Most personnel are aware of the danger of electrical shock, even electrocution. It is the one electrical hazard around which most electrical safety standards have been built. However, few really understand just how little current is required to cause injury, even death. Actually, the current drawn by a 7½W, 120V lamp, passing across the chest, from hand-to-hand or hand-to-foot, is enough to cause fatal electrocution.

The effects of electric current on the human body depend on the following:

- Circuit characteristics (current, resistance, frequency, and voltage)
- Contact resistance and internal resistance of the body
- The current’s pathway through the body, determined by contact location and internal body chemistry
- Duration of the contact
- Environmental conditions that affect the body’s contact resistance



To understand the currents possible in the human body, it is important to understand the contact resistance of skin (see Table V(A)(1)). The skin's resistance can change as a function of the moisture present in its external and internal layers, with changes due to such factors as ambient temperatures, humidity, fright, and anxiety.

Table V(A)(1). Human Resistance Values for Skin-Contact Conditions*

Condition	Resistance (ohms)	
	Dry	Wet
Finger touch	40,000 to 1,000	4,000 to 15,000
Hand holding wire	15,000 to 50,000	3,000 to 6,000
Finger-thumb grasp	10,000 to 30,000	2,000 to 5,000
Hand holding pliers	5,000 to 10,000	1,000 to 3,000
Palm touch	3,000 to 8,000	1,000 to 2,000
Hand around 1½ inch pipe	1,000 to 3,000	500 to 1,500
Two hands around 1½ inch pipe	500 to 1,500	250 to 750
Hand immersed		200 to 500
Foot immersed		100 to 300
Human body, internal, excluding skin	200 to 1,000	

*This table was compiled from data developed by Kouwenhoven and Milnor.

Body tissue, vital organs, blood vessels and nerve (non-fat) tissue in the human body contain water and electrolytes, and are highly conductive with limited resistance to alternating electrical current. As the resistance of the skin is broken down by electrical current, resistance drops and current levels increase.

The human body could be considered as a resistor with hand-to-hand resistance (R) of only 1,000 Ohms. The voltage (V) determines the amount of current passing through the body.

While 1,000 Ohms might appear to be low, even lower levels can be approached by a person with sweat-soaked cloth gloves on both hands and a full-hand grasp of a large, energized conductor and a grounded pipe or conduit. Moreover, cuts, abrasions or blisters on hands can negate skin resistance, leaving only internal body resistance to oppose current flow. A circuit in the range of 50V could be dangerous in this instance.

Ohm's Law: I (amps) = V (volts) / R (ohms)

Example 1: $I = 480 / 1000 = 480\text{mA}$ (or 0.480A)

Product standards consider 4 to 6mA to be the safe upper limit for children and adults (hence the reason a 5-milliamp-rated GFCI circuit).

Note: *GFCIs do not protect against a line-to-neutral or a line-to-line shock.*

Electrical currents can cause muscles to lock up, resulting in an inability of a person to release his or her grip

from the current source. This is known as the "let-go" threshold current. This current level varies with the frequency (see Table V(A)(2)). DC currents usually cause a single twitch and are considered less dangerous at lower voltage levels. Alternating currents in the frequency range of skeletal muscles (40 to 150Hz) are more serious (e.g., 60Hz).

At 60Hz, most females have a "let-go" limit of about 6 milliamperes (mA), with an average of 10.5mA. Most males have a "let-go" limit above 9mA, with an average of 15.5mA. (These limits are based on smaller average size of females. Therefore, a small man could have a lower limit, or a larger woman a higher limit.)

Sensitivity, and potential injury, also increase with time. A victim who cannot "let go" of a current source is much more likely to be electrocuted than someone whose reaction removes them from the circuit more quickly. The victim who is exposed for only a fraction of a second is less likely to sustain an injury.

The most damaging path for electrical current is through the chest cavity (see A and D in Figure V(A)) and head. In short, any prolonged exposure to 60Hz current of 10mA or more might be fatal. Fatal ventricular fibrillation of the heart (stopping of rhythmic pumping action) can be initiated by a current flow of as little as several milliamperes. These injuries can cause fatalities resulting from either direct paralysis of the respiratory system, failure of the rhythmic heart pumping action, or immediate heart stoppage.

Table V(A)(2). The Effects of Electrical Current on the Body*

Effects	Current (mA)					
	Direct Current		Alternating Current			
			60Hz		10Hz	
	Men	Women	Men	Women	Men	Women
Slight sensation on hand	1	0.6	0.4	0.3	7.0	5.0
Median perception threshold	6.2	3.5	1.1	0.7	12.0	8.0
Shock-not painful; without loss of muscular control	9.0	6.0	1.8	1.2	17.0	11.0
Painful shock-threshold for muscular control loss	62.0	41.0	9.0	6.0	55.0	37.0
Painful shock-median "let-go" threshold	76.0	51.0	16.0	10.5	75.0	50
Painful and severe shock-breathing difficult; loss of muscular control	90.0	60.0	23.0	15.0	94.0	63.0

* Modified from *Deleterious Effects of Electric Shock* by Charles F. Dalziel.



During fibrillation, the victim might become unconscious. On the other hand, he or she might be conscious, deny needing help, walk a few feet, and then collapse. Death could occur within a few minutes or take hours. Prompt medical attention is needed for anyone receiving electrical shock. Many of these people can be saved, provided they receive proper medical treatment, including cardiopulmonary resuscitation (CPR) quickly.

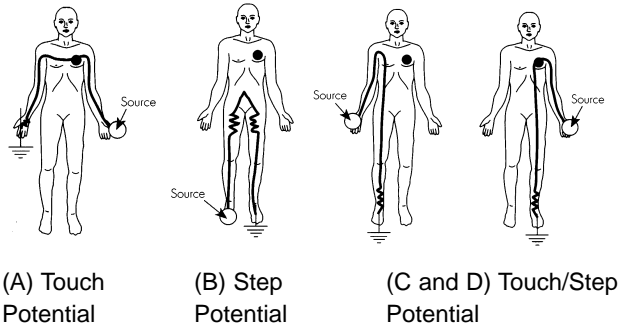

Figure V(A). Current Pathways through the Body

Table V(A)(3). Effects of Electrical Shock (60Hz AC)

Response*	60hz, AC Current
Tingling sensation	0.5 to 3mA
Muscle contraction and pain	3 to 10mA
“Let-go” threshold	10 to 40mA
Respiratory paralysis	30 to 75mA
Heart fibrillation; might clamp tight	100 to 200mA
Tissue and organs burn	More than 1,500mA

* The degree of injury also depends on the duration and frequency of the current.

Think of electrical shock injuries as “icebergs,” where most of the injury is unseen, below the surface. Entrance and exit wounds are usually coagulated areas and might have some charring, or these areas might be missing, having “exploded” away from the body due to the level of energy present. The smaller the area of contact, the greater the heat produced. For a given current, damage in the limbs might be the greatest, due to the higher current flux per unit of cross-sectional area.

Within the body, the current can burn internal body parts in its path. This type of injury might be difficult to diagnose, as the only initial signs of injury are the entry and exit wounds. Damage to the internal tissues, while not apparent immediately, might cause delayed internal tissue swelling and irritation. Prompt medical attention can minimize possible loss of blood circulation and the potential for amputation of the affected extremity, and can prevent death.

All electrocutions are preventable. A significant part of the OSHA standard is dedicated to electrical safety. It would be an oversimplification to state that everyone

should comply with the standards. However, OSHA standard compliance is considered a minimum requirement and seen as a very good place to start for improving the safety of the workplace.

Any time an electrocution occurs, potential for both a civil lawsuit and an OSHA citation exists. It is always a good proactive measure to review internal safety procedures when investigating industrial incidents. The investigator must make sure that he or she has an accurate set of facts to work with. Incidents are always costly, and most can be avoided.

Several standards offer guidance regarding safe approach distances to minimize the possibility of shock from exposed electrical conductors of different voltage levels. The most recent, and probably the most authoritative guidance, is presented in *NFPA 70E*. Safe approach distances to exposed energized electrical conductors are discussed in Section IX(D) of this handbook.

B. Arcing faults: arc-flash and arc-blast

1. Arc fault basics

Following is a graphical model of an arcing fault and the physical consequences that can occur. The unique aspect of an arcing fault is that the fault current flows through the air between conductors or a conductor(s) and a grounded part. The arc has an associated arc voltage because there is arc impedance. The product of the fault current and arc voltage in a concentrated area, results in tremendous energy being released in several forms.

The resulting energies can be in the form of radiant heat, intense light, and tremendous pressures. Intense radiant heat from the arcing source travels at the speed of light. The temperature of the arc terminals can reach approximately 35,000°F, or about four times as hot as the surface of the sun. No material on earth can withstand this temperature. The high arc temperature changes the state of conductors from solid to hot molten metal and to vapor. The immediate vaporization of the conductors is an explosive change in state from solid to vapor. Copper vapor expands to 67,000 times the volume of solid copper. Because of the expansive vaporization of conductive metal, a line-to-line or line-to-ground arcing fault can escalate into a three-phase arcing fault in less than a thousandth of a second.

The extremely high release of thermal energy superheats the immediate surrounding air. The air also expands in an explosive manner. The rapid vaporization of conductors and superheating of air result in high pressure waves and a conductive plasma cloud, that if large enough, can engulf a person. The thermal shock and pressures can violently destroy circuit com-



ponents. The pressure waves hurl the destroyed, fragmented components like shrapnel at high velocity; shrapnel fragments can be expelled in excess of 700 miles-per-hour. Molten metal droplets at high temperatures typically are blown out from the event due to the pressure waves.

Electrical Arc

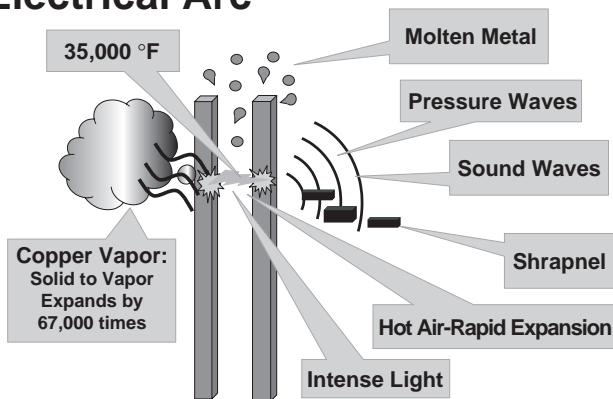

Testing has proven that the arcing fault current magnitude and time duration are the most critical variables in determining the energy released. It is important to note that the predictability of arc-faults and the energy released by an arc-fault is subject to significant variance. Some of the variables that affect the outcome include: available bolted short-circuit current, the time the fault is permitted to flow (speed of the overcurrent protective device), arc gap spacing, size of the enclosure or no enclosure, power factor of fault, system voltage, whether the arcing fault can sustain itself, type of system grounding scheme, and distance the worker's body parts are from the arc. Typically, engineering data that the industry provides concerning arcing faults is based on specific values of these variables. For instance, for 600V and less systems, much of the data has been gathered from testing on systems with an arc gap spacing of 1.25 inches and incident energy determined at 18 inches from the point of the arc-fault.

2. Arc-flash and arc-blast

As previously discussed an arcing fault releases thermal energies and pressure. The effects of arcing faults can be broadly categorized as arc-flash and arc-blast. The arc-flash is associated with the release of tremendous thermal energies and the arc-blast is associated with the release of tremendous pressure. The industry is devising ways to quantify the risks associated with arc-flash hazards. However, there is little or no information on arc-blast hazard risk assessment or on protecting workers due to the arc-blast hazard. Neither *NFPA 70E* nor the current edition of *IEEE 1584 Guide For Performing Arc-flash Hazard Calculations*, account for the pressure and shrapnel that can result due to an arcing fault.

3. How arc-faults can affect humans

Nearly everyone is aware that an electrical shock is a hazard that can ultimately lead to death. In fact, while many people have experienced minor shocks, few have realized any real consequences, making them somewhat complacent. In contrast, few people are aware of the extreme nature of electrical arc-faults; the potential of severe burns associated from arc-flash and the potential injuries due to high pressures from arc-blast. But this is starting to change, people are learning that the effects of an arcing fault can be devastating to humans.

In recent years, awareness of arc-flash hazards has been increasing. Recent studies of reported electrical injuries have indicated that as many as 80 percent of documented injury cases were burns resulting from exposure to electrical arcs. In addition, each year more than 2,000 people are admitted to burn centers in the U.S. with severe electrical burns. Electrical burns are considered extremely hazardous for a number of reasons. One important reason is that contact with the circuit is not necessary to incur a serious, even deadly, burn. Serious or fatal burns can occur at distances of more than 10 feet from the source of a flash.

Since burns are such a prevalent consequence of electrical incidents, the three basic types are mentioned below. These can be due to contact (shock hazard) or arc-flash.

- **Electrical burns due to current flow** — tissue damage (whether skin deep or deeper) occurs because the body is unable to dissipate the heat from the current flow through the body. The damage to a person's tissue can be internal and initially not obvious from external examination. Typically, electrical burns are slow to heal and frequently result in amputation.
- **Arc burns by radiant heat** — caused by electrical arcs. Temperatures generated by electric arcs can burn flesh and ignite clothing at distances of 10 feet or more.
- **Thermal contact burns** — normally experienced from skin contact with the hot surfaces of overheated electric conductors or a person's clothing apparel that ignites due to an arc-flash.

The human body survives in a relatively narrow temperature range around 97.7°F. Studies show that when the skin temperature is as low as 110°F, the body's temperature equilibrium begins to break down in about 6 hours. At 158°F, only one second duration is sufficient to cause total cell destruction. Human skin at temperatures of 205°F for more than one-tenth of one second can cause incurable, third-degree burns (see Table V(B)).



Table V(B). Skin Temperature Tolerance Relationship

Skin Temperature	Duration	Damage Caused
110°F	6.0 hours	Cell breakdown begins
158°F	1.0 second	Total cell destruction
176°F	0.1 second	Curable (second-degree) burn
205°F	0.1 second	Incurable (third-degree) burn

For evaluating burns, protective properties of personal protection equipment, and the thermal energy resulting from an arc-flash, the industry has progressed to utilizing calories/centimeters² (cal/cm²) as a unit of measure. For instance, the incident energy is a measure of thermal energy at a specific distance from an arc-fault; the unit of measure is typically in cal/cm². Another example where cal/cm² is used as a measure is for various types of PPE with distinct levels of thermal protection capabilities rated in cal/cm².

1.2 cal/cm² is considered the threshold for a curable (second-degree) burn.

Note: *medical treatment may still be required if bare skin is exposed to this level of flash — full recovery would be expected.*

In addition to burn injuries, victims of arcing faults can experience damage to their sight, hearing, lungs, skeletal system, respiratory system, muscular system, and nervous system. The speed of an arcing fault event can be so rapid that the human system can not react quickly enough for a worker to take corrective measures. The radiant thermal waves, the high pressure waves, the spewing of hot molten metal, the intense light, the hurling shrapnel, and the hot, conductive plasma cloud can be devastating in a small fraction of a second. The intense thermal energy released can cause severe burns or ignite flammable clothing. Molten metal blown out can burn skin or ignite flammable clothing. Failure to remove or extinguish burning clothing quickly enough can cause serious burns over much of the body. A person can gasp and inhale hot air and vaporized metal sustaining severe injury to their respiratory system. The tremendous pressure blast from the vaporization of conducting materials and superheating of air can fracture ribs, collapse lungs and knock workers off ladders or blow them across a room.

What is difficult for people to comprehend is that the time in which the arcing fault event runs its course may only be a small fraction of a second. In a matter of only a thousandth of a second or so, a single phase arcing fault can escalate to a three phase arcing fault. Tremendous energies can be released in a few hundredths of a second. Humans can not detect, much less comprehend and react to events in these time frames.

There is a greater respect for arcing fault and shock hazards on medium and high

voltage systems. However, injury reports show serious accidents are occurring at an alarming rate on systems of 600V or less (notably 480V systems and to a lesser degree 208V systems), in part because of the high fault currents that are possible. But also, designers, management and workers mistakenly tend not to take the necessary precautions that they take when designing or working on medium and high voltage systems.

VI. The Role of Overcurrent Protective Devices In Electrical Safety

If an arcing fault occurs while a worker is in close proximity, the survivability of the worker is mostly dependent upon (1) the characteristics of the overcurrent protective devices, (2) the arc-fault current, and (3) precautions the worker has taken prior to the event, such as wearing personal protective equipment appropriate for the hazard. The selection and performance of overcurrent protective devices play a significant role in electrical safety. Extensive tests and analysis by industry have shown that the energy released during an arcing fault is related to two characteristics of the overcurrent protective device protecting the affected circuit:

1. The time it takes the overcurrent protective device to open. The faster the fault is cleared by the overcurrent protective device, the lower the energy released.
2. The amount of fault current the overcurrent protective device lets through. Current-limiting overcurrent protective devices may reduce the current let-through (when the fault current is within the current-limiting range of the overcurrent protective device) and can reduce the energy released.

Lowering the energy released is better for both worker safety and equipment protection. The photos and recording sensor readings from actual arcing fault tests (next page) illustrate this point very well. An ad hoc electrical safety working group within the IEEE Petroleum and Chemical Industry Committee conducted these tests to investigate arc-fault hazards. These tests and others are detailed in "Staged Tests Increase Awareness of Arc-Fault Hazards in Electrical Equipment," *IEEE Petroleum and Chemical Industry Conference Record*, September 1997, pp. 313-322. This paper can be found at www.bussmann.com under Services/Safety BASiCs. One finding of this IEEE paper is that current-limiting overcurrent protective devices reduce damage and arc-fault energy (provided the fault current is within the current-limiting range). To better assess the benefit of limiting the current of an arcing fault, it is important to note some key thresholds of injury for humans. Results of these tests were recorded by sensors on mannequins and can be compared to these parameters:



Thresholds for injury to humans

- Just Curable Burn Threshold: 80°C / 176°F (0.1 sec)
- Incurable Burn Threshold: 96°C / 205°F (0.1 sec)
- Eardrum Rupture Threshold: 720 lbs/ft²
- Lung Damage Threshold: 1728 - 2160 lbs/ft²
- OSHA Required Ear Protection Threshold: 85db (for sustained time period)*

*An increase of 3db is equivalent to doubling the sound level.

Staged arc-flash tests

Test 4, Test 3 and Test 1: General All three of these tests were conducted on the same electrical circuit set-up with an available bolted three-phase, short-circuit current of 22,600 symmetrical rms amps at 480V. In each case, an arcing fault was initiated in a Size 1 combination motor controller enclosure with the door open, as if an electrician were working on the unit while energized or before it was placed in an electrically safe work condition. Test 4 and Test 3 were identical except for the overcurrent protective device protecting the circuit. In Test 4, a 640A circuit breaker with a short-time delay is protecting the circuit; the circuit was cleared in 6 cycles. In Test 3, KRP-C-601SP, 601A, current-limiting fuses (Class L) are protecting the circuit; they opened the fault current in less than $\frac{1}{2}$ cycle and limited the current. The arcing fault was initiated on the line side of the motor branch circuit device in both Test 4 and Test 3. This means the fault is on the feeder circuit but within the controller enclosure. In Test 1, the arcing fault is initiated on the load side of the branch circuit overcurrent protective devices, which are LPS-RK 30SP, 30A, current-limiting fuses (Class RK1). These fuses limited this fault current to a much lower amount and clear the circuit in approximately $\frac{1}{4}$ cycle or less.

A couple of conclusions can be drawn from this testing:

1. Arcing faults can release tremendous amounts of energy in many forms in a very short period of time. All the measured values can be compared to key thresholds of injury for humans given in a previous paragraph. Test 4 was protected by a 640A, non-current-limiting device that opened in 6 cycles or $\frac{1}{10}$ second (0.1 second).
2. The overcurrent protective devices' characteristic can have a significant impact on the outcome. A 601A current-limiting overcurrent protective device, protects the circuit in Test 3. The current that flowed was reduced (limited), and the clearing time was $\frac{1}{2}$ cycle or less. This was a significant reduction compared to Test 4. Compare the Test 3 measured values to the key thresholds of injury for humans and the Test 4 results. The measured results of Test 1 are significantly less than those in

Test 4 and even those in Test 3. The reason is that Test 1 utilized a much smaller (30A), current-limiting device. Test 3 and Test 1 both show that there are benefits of using current-limiting overcurrent protective devices. Test 1 just proves the point that the greater the current-limitation, the more the arcing fault energy may be reduced. Both Test 3 and Test 1 utilized very current-limiting fuses, but the lower amps-rated fuses limit the current more than the larger amps rated fuses. It is important to note that the fault current must be in the current-limiting range of the overcurrent protective device to receive the benefit of the lower current let-through. See the diagram that depicts the oscillographs of Test 4, Test 3 and Test 1.

Current-Limitation: Arc-Energy Reduction

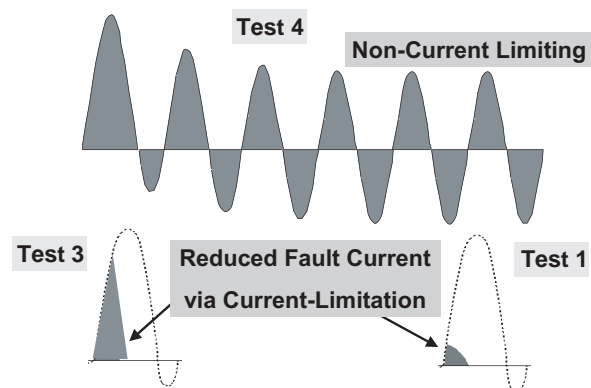

3. The cotton shirt reduced the thermal energy exposure on the chest (T3 measured temperature under the cotton shirt). This illustrates the benefit of workers wearing protective garments.

Following are the results recorded from the various sensors on the mannequin closest to the arcing fault. T1 and T2 recorded the temperature on the bare hand and neck respectively. The hand with T1 sensor was very close to the arcing fault. T3 recorded the temperature on the chest under the cotton shirt. P1 recorded the pressure on the chest. And the sound level was measured at the ear. Some results "pegged the meter." That is, the specific measurements were unable to be recorded in some cases because the actual level exceeded the range of the sensor/recorder setting. These values are shown as >, which indicates that the actual value *exceeded* the value given but it is unknown how high of a level the actual value attained.



Photos and results Test 4: Staged test protected by circuit breaker with short-time delay (not a current-limiting overcurrent protective device). Short-time delay intentionally delayed opening for six cycles (0.1 second). Note: Unexpectedly, there was an additional fault in the wireway and the blast caused the cover to hit the mannequin in the head.



Photos and results Test 3: Staged test protected by KRP-C-601SP LOW-PEAK® current-limiting fuses (Class L). These fuses were in their current-limiting range and cleared in less than a 1/2 cycle (0.0083 seconds).

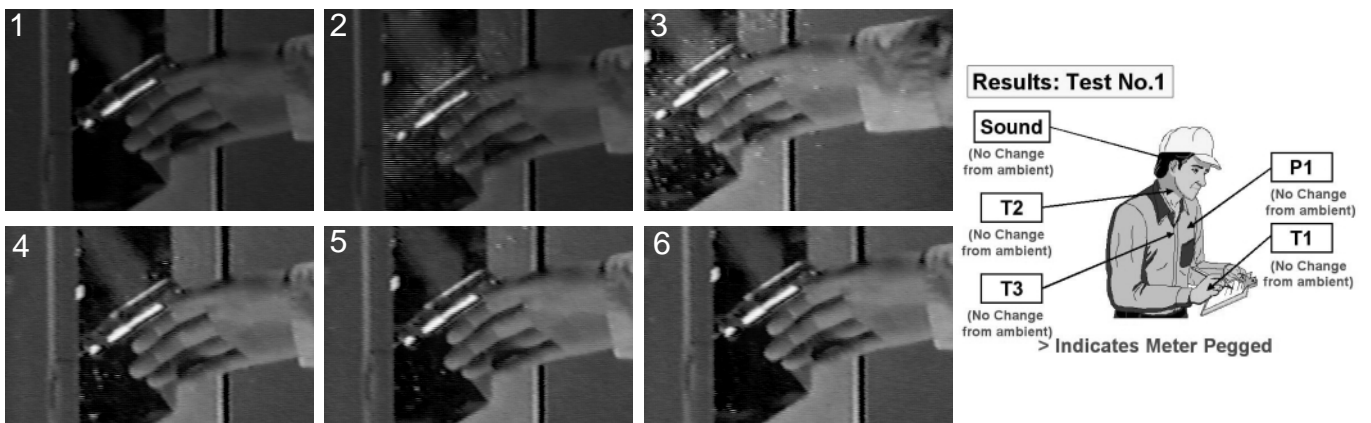

Photos and results Test 1: Staged test protected by LPS-RK-30SP, LOW-PEAK® current-limiting fuses (Class RK1). These fuses were in current-limiting range and cleared in approximately 1/4 cycle (0.004 seconds).

VII. Attending to Electrical Incident Victims

A. Preparedness

Site personnel should be trained in CPR and first-aid techniques to prepare for possible electrical incidents. CPR training and periodic retraining of site personnel must be carefully planned and documented.

First-aid supplies approved by the consulting physician should be easily accessible when required. The first-aid kit should consist of materials approved by the consulting physician, in a weatherproof container with individually sealed packages for each type of item. The contents of the first-aid kit should be checked weekly to ensure that all supplies are present and in good order.

Plans must be in place for transporting incident victims to a physician or hospital. Recovery of electrical incident victims can be greatly enhanced if they are quickly transported to a burn center or other medical facility that specializes in electrical trauma. Employers should evaluate medical facilities in their area and determine in advance where such victims should be taken and how they will be transported. Emergency telephone numbers and specific instructions should be conspicuously posted. All employees should be thoroughly familiar with the procedures.

Locations of eyewash stations and safety showers must be posted so that they are easily found to cool and flush the burn victim after an incident.

B. Effects of electrical incidents

Electrical incidents and the complexities of the trauma they cause to the human body historically have been surrounded by mystery and lack of understanding. As more knowledge is gained about electrical trauma, strategies for effectively handling the emergency and ways to improve hospital treatment of victims become more apparent. In addition, research suggests ways in which workplace supervisors and responders can help an incident victim's caregivers provide appropriate medical attention.

In the case of an electrical incident, the extent of injury to the victim often is not immediately apparent. Some symptoms might be masked by the more readily apparent thermal effects of the injury (burns). Caregivers must be aware of additional possible biological effects of electric shock.

In an arc-flash or arc-blast energy incident, the victim's skin, ears, eyes, lungs, internal organs, and nervous, muscular, and skeletal systems can be affected not only by the direct effects of electrical current, but also by the following:

- Radiant heat from an electrical arc that produces extremely high temperatures
- Disturbance of the heart's electrical conduction, causing changes in the heart rhythm or possible cardiac arrest
- Barotrauma from the acoustic and vibratory forces around arc-blast
- Inhaled or deposited vapors released through an arc explosion

Incident victims also are subject to the following types of injury related to contact with electricity:

- Low-voltage contact wounds
- High-voltage contact wounds of entry and exit of electrical current
- Burns
- Respiratory difficulties (The tongue might swell and obstruct the airway, or vaporized metal or heated air might have been inhaled.)
- Infectious complications
- Injury to bone through falls, heat necrosis (death of tissue), and muscle contraction (Shoulder joint injuries and fracture of bones in the neck are common injuries caused by muscle contraction.)
- Injury to the heart, such as ventricular fibrillation, cardiac arrest, or stoppage
- Internal organ injuries
- Neurological (nerve) injury
- Injury to the eyes (Cataracts from electrical injury have been reported up to three years after an incident.)

C. Enhancement of chances for recovery

In most electrical incidents, the inability to diagnose the extent of injury at the time of admission to the hospital can delay the patient's treatment. Recovery can be enhanced by more detailed information about the incident, including the system voltage, amount of available current, length of contact with current, and possibility of arc-flash. Recovery can be maximized by transporting the victim as quickly as possible to a burn center or other facility that specializes in treatment of electrical trauma.

Procedures

In response to an electrical incident, the following procedures should be followed immediately:

- Remove the immediate hazard; turn off the power. If you are a witness to an electrical incident, exercise great caution that you do not sustain injury as well. Always assume that the source of electricity is still energized unless you or another



qualified person determines that the power has been turned off. Unless you are using insulated equipment (e.g., voltage-rated gloves, hot sticks, or a rubber blanket) to dislodge a victim, you must delay the rescue effort until the circuit can be interrupted.

Note: Sites must establish a training policy and plan to cover electrical rescue methods, approved rescue devices, and CPR training.

- Realize that speed is essential. The victim's potential for injury increases with contact time. The resistance of the body is mostly in the skin. If the skin breaks down electrically, only the low internal body resistance remains to impede current.
- Call for help. Delegate someone else to get help, if possible. Make sure that an ambulance or emergency medical service is on the way.
- Begin CPR. If the victim's pulse or breathing has stopped, cardiopulmonary resuscitation (CPR) is essential to avoid brain damage, which usually begins in four to six minutes. If CPR is needed, make sure assistance is on the way but do not wait for help to arrive.

Make sure you and the victim are in a safe zone (not in contact with any electrical source and out of reach of any downed or broken wires). If the person is unconscious, begin the CPR sequence.

- Apply first aid to the victim.
 - If the person's clothing is on fire, remind him/her to drop and roll, or tackle him/her, if necessary, to smother the flames.
 - Cool the burn with water or saline for a few minutes or until the skin returns to normal temperature. (For flash-burn victims, safety showers might be the best method, due to the possibility of wide-spread surface burns on the body.) Do not attempt to remove clothing that is stuck to a burn.
 - Remove constricting items such as shoes, belts, jewelry, and tight collars from the victim.
 - Elevate burned limbs to reduce swelling.
 - Handle the victim with care, being aware that he or she might have broken bones or spinal injuries.
 - Treat for shock: maintain body temperature, do not give anything by mouth. Administer high concentrations of oxygen, if available.
 - Keep the victim warm and as comfortable as possible while awaiting transport to the medical facility. Cover him or her with clean, dry sheets or blankets. Cover burn wound(s) with sterile dressings or clean sheets.

Additional Information

After the victim's immediate needs are met, note as many details of the incident as possible. The details can help an incident victim's caregivers provide appropriate medical attention.

It is especially important that hospital personnel know the cause of the victim's injuries. They need to know if the victim had contact with electricity or if arc-flash caused the injuries.

While the victim of electrical contact might suffer some surface burns where the current entered the body, he or she often suffers additional, less visible (internal) damage because of the path of the current through the body.

The flash burn victim is more likely to have greater evident burn damage on the surface of the body, due to the extremely high temperatures from arc-flash. He or she is likely to suffer first, second, and third-degree burns, especially on the face, wrists, ears, back of the head, neck, and ankles. Any skin surface that is not covered adequately by protective clothing or equipment is at risk.

In addition to burns to the skin, the flash burn victim also might have inhaled metal vapor (such as copper) into the lungs or suffered adverse effects (such as damage to the eardrum) due to the pressure wave caused by arc-blast.

Advance Help for Incident Victims

Each site should prepare a checklist in advance that will provide detailed information about an incident (see the sample checklist in the Annex A). This list should be a part of a site's emergency response plan for electrical injuries. This checklist should be readily available on site, and its existence should be communicated to all employees. A completed copy should accompany the victim to the hospital or treatment center, if at all possible.

The information can help to ensure the best possible evaluation and treatment by initial medical caregivers.

VIII. Who Is Responsible for Safety?

In most instances, three distinctly different entities are associated with a project or site: the employer, the employee, and the owner. When discussing responsibility, it is important to understand the existence of these different roles.

- The *employer* can be thought of in terms of a person who represents the *company*. The employer, then, can be the owner of the company or any member of the line management of the organization.



- On the other hand, the *employee* is the electrician or other worker. A first or second line supervisor, then, has two roles. He or she might be a representative of the company, operating as an employer, in addition to being an employee.
- The term *owner* has still a different twist. Rather than a person, the owner is the entity that *owns* the equipment or facility. The owner has a role and responsibility that is somewhat different from either employer or employee.

In The Act, OSHA is chartered to establish requirements for *employers*. It has no jurisdiction to assign responsibilities to employees. Therefore, meeting requirements defined by OSHA is the responsibility of the employer (management of the company). It is the employer who must:

- provide for a safe workplace
- establish and implement a safety program
- establish an enforcement policy to ensure that employees follow established practices

In the case where a *contractor* is performing work on a site or facility owned by someone else, some inherent responsibilities must be assumed by the *owner*. Perhaps the most important of those responsibilities is to make sure that the contractor is fully apprised of all hazards existing that might impact the work.

National consensus standards are not similarly constrained. As a result, *NFPA 70E* also assigns responsibility. Responsibility assigned to the employer is the same as in 29 CFR 1910, Subpart S. The employer's responsibilities include the development and implementation of an electrical safety program, and the development of safety procedures and guidelines for an employee safety training program on proper implementation of those procedures.

NFPA 70E suggests that employees are responsible for implementing the program and procedures provided by the employer. The standard goes on to suggest that although responsibility of employer and employee are distinct and clear, the most effective process is to establish a close working relationship between employer and employee in which each has value for the other as they work together.

IX. Electrical Incident and Hazard Prevention

A. Not working on or near

According to OSHA 1910.333(a)(1) and *NFPA 70E* 130.1, workers shall not work on or near exposed live parts except for two demonstrable reasons:

1. De-energizing introduces additional or increased hazards (such as cutting ventilation to a hazardous location) or

2. Infeasible due to equipment design or operational limitations (such as when performing diagnostics and testing for startup or troubleshooting and this work can only be done when circuits are energized).

So, for circumstances other than the two exceptions, the circuits/equipment shall be put in **an electrically safe work condition** prior to commencing electrical work.

B. Electrically safe work condition

An *electrically safe work condition* is a concept first introduced in *NFPA 70E*. This term is now defined in *NFPA 70E* Definitions and the steps to put a circuit in an electrically safe work condition are detailed in 70E-120.1.

The concept embraces several ideas and suggests that six different steps must be taken before an electrical circuit is safe to approach or touch without PPE. Electricians and other workers tend to believe that a circuit is safe to approach or touch if it is de-energized. The fact that injuries continue rather frequently, based upon this belief, proves that additional steps are needed.

Some people also believe that if a lock and tag are placed on a labeled disconnecting means, the equipment is safe to work on. However, other issues must be considered. For example, labels can be marked incorrectly, equipment can be supplied from more than one source, or a temporary conductor could have been installed. It also is feasible that an unrelated energized circuit conductor could contact the conductor leading to the work area.

In other instances, workers outside the area or complicated systems can affect the work area. Often it is assumed that if the contact point is tested for absence of voltage, the point is safe for executing the task. But this only proves that no voltage is present at the time of the voltage test. Voltage could be absent due to a process interlock being open, or a second source of energy could simply be turned off for the moment. Avoiding incidents and injury requires training, planning, and preparation.

NFPA 70E 120.1 requires a process of six discrete and independent steps be executed prior to declaring the existence of an electrically safe work condition. Only after the following steps have been executed can work begin without possible exposure to an electrical hazard.

1. Determine all possible sources of energy. Review all reliable and up-to-date drawings, documentation, and identification tags and labels. Drawings must include **all** energy sources, including temporary and back up power sources.



2. After properly interrupting the load, open all disconnecting devices for the circuit. At this point, the equipment or circuit is simply de-energized.
3. Where possible, visually verify that all disconnecting devices, including drawout circuit breakers, are open. Also check that all disconnecting devices meet appropriate codes and standards.
4. Apply lockout/tagout devices in accordance with documented and established policy. An established policy is an enforced written procedure made available to all employees.
5. Use adequately rated voltage testers to verify the absence of voltage on each point where physical contact is expected. Employees are required to use only voltage testing equipment that is rated by a third party.
6. Where the possibility of induced voltage or stored energy exists, ground the phase conductors before touching them. Where it is reasonable to expect that the conductors could be re-energized due to accidental contact with another source of energy, install grounding devices rated for the available fault current.

Until these six steps have been adequately executed, some potential of exposure to an electrical hazard still exists.

Note: *While putting circuits/equipment in an electrically safe work condition, safe work practices appropriate for the circuit voltage and arc-flash energy level shall be used, including adequate personal protective equipment [70E-120.2(A)]. When a disconnect is opened, the circuit may be de-energized but the circuit is not yet considered to be in an electrically safe work condition until all the above steps of 70E-120.1 are successfully completed. For instance, voltage testing of each conductor, which is a necessary step while putting a circuit in an electrically safe work condition, requires adequate PPE. Essentially the same requirement is in OSHA 1910.333(b) which considers de-energized circuits as energized until all the appropriate steps have been completed successfully.*

C. Shock hazard and flash hazard analysis

If a worker is to work on or near exposed conductors that will not be in an electrically safe work condition, a shock hazard analysis and flash hazard analysis are required.

NFPA 70E 110.8(B)(1)

(a) Shock Hazard Analysis. A shock hazard analysis shall determine the voltage to which personnel will be exposed, boundary requirements, and the personal protective equipment necessary in order to minimize the possibility of electrical shock to personnel.

FPN: See 130.2 for the requirements of conducting a shock hazard analysis.

(b) Flash Hazard analysis. A flash hazard analysis shall be done in order to protect personnel from the possibility of being injured by an arc-flash.

The analysis shall determine the Flash Protection Boundary and the personal protective equipment that people within the Flash Protection Boundary shall use.

FPN: See 130.3 for the requirements of conducting a flash hazard analysis.

NFPA 70E has developed requirements to reduce the risk of injury to workers due to shock and arc-flash hazards. There are three shock approach boundaries in *NFPA 70E* Table 130.2(C) that are required to be observed. These shock approach boundaries are dependent upon the system voltage and are discussed in the next section.

As has been discussed, arc-fault currents can release tremendous amounts of energy. *NFPA 70E* requires that before a worker approaches exposed electric conductors or circuit parts that have not been placed in an electrically safe work condition; a flash hazard analysis must be performed. The flash hazard analysis must determine the flash protection boundary (FPB) and level of personal protective equipment (PPE) that the worker must wear. The flash protection boundary is the distance from the energized parts at which a worker could sustain a just curable burn (bare skin) as a result of an arcing fault. A worker entering the flash protection boundary must be qualified and must be wearing appropriate PPE. This will be covered in greater depth in the Flash Hazard Analysis Section.



The following figure depicts the flash protection boundary and the three shock approach boundaries that shall be observed per *NFPA 70E*. In an actual situation, before a worker is permitted to approach equipment with exposed parts that have not been placed in an electrically safe work condition, these boundaries must be determined. In addition, the worker must be wearing the required level of PPE, which can be determined by shock and flash hazard analysis. It is important to observe the shock approach boundaries together with the flash protection boundary; do not only observe the shock approach boundaries to the exclusion of the flash protection boundaries or visa-versa. This figure is an over-simpli-

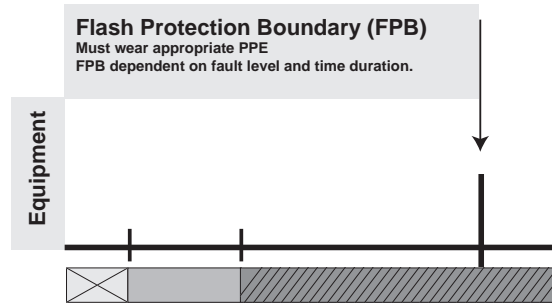

fication. The *NFPA 70E* distance for each boundary is in all directions from the exposed parts, which creates a protection boundary sphere.



Shock Approach Boundaries

-  Prohibited: Qualified Persons Only. PPE as if direct contact with live part
-  Restricted: Qualified Persons Only
-  Limited: Qualified or Unqualified Persons*
*Only if accompanied by Qualified Person

Note: shock approach boundaries dependent on system voltage level

D. Approach boundaries for shock protection

Table IX(D) (based on Table 130.2(C) in *NFPA 70E*) provides approach distances to exposed energized electrical conductors. The table identifies boundaries for limited approach, restricted approach, and prohibited approach. The table establishes satisfactory distances between a qualified or unqualified person and conductors that have not been placed in an electrically safe work condition.

- The **limited approach boundary** (columns 2 and 3) is the limit of approach distance for unqualified persons to a live part. In concept, unqualified people are less capable of recognizing a shock and flash hazard. Therefore, these persons should remain at a safer distance from open, energized conductors. When there is a need for an unqualified person to cross the limited approach boundary to perform a minor task, or look at equipment, a qualified person shall advise him/her of the possible hazards and ensure the unqualified person is safeguarded. Under no circumstances shall an unqualified person be permitted to cross the restricted approach boundary.

The *exposed movable conductor* (column 2) is intended to mean that either the conductor might move (as in an overhead line) or the person might move (as in an articulating support platform). A fixed circuit part (column 3) refers to a task where the conductor is not expected to move, such as within a unit substation.

- The **restricted approach boundary** (column 4) is the closest distance for an *unqualified* person. Under no circumstances shall an unqualified person be permitted to cross the restricted approach boundary. To cross this boundary, a person must meet the following criteria:

- Be a *qualified* person
- Have an approved plan
- Use PPE approved for the conditions
- Position his or her body in a way that minimizes risk of inadvertent contact

In some instances, work outside the restricted approach boundary but within the person's reach may be classified as restricted work if, in the judgment of the personnel involved, conductive objects or ungrounded body parts could make unintentional contact or cross the prohibited approach boundary.

- The **prohibited approach boundary** (column 5) is the minimum approach distance to an exposed energized conductor or circuit part and is the closest point to prevent flashover. To cross this boundary and enter the prohibited space shall be considered the same as making contact with exposed energized conductors or circuit parts.

To cross the prohibited approach boundary, the qualified person must do the following:

- Have specified training to work on energized conductors or circuit parts
- Have a documented plan that justifies the need to work inside the prohibited approach boundary
- Perform a hazard risk analysis
- Have both the documented justification plan and the hazard risk analysis approved by the site manager
- Use PPE appropriate for working on exposed energized conductors or circuit parts and rated for the voltage and energy level involved

Table IX(D). Approach Boundaries to Live Parts for Shock Protection [NFPA 70E, Table 130.2(C)]

1	2	3	4	5
	Limited Approach Boundary ¹		Restricted Approach Boundary ¹	Prohibited Approach Boundary ¹
Nominal Voltage Range Phase-to-Phase	Exposed Movable Conductor	Exposed Fixed Circuit Part	Includes Inadvertent Movement Adder	
0 to 50	Not specified	Not specified	Not specified	Not specified
51 to 300	10 ft. 0 in.	3 ft. 6 in.	Avoid contact	Avoid contact
301 to 750	10 ft. 0 in.	3 ft. 6 in.	1 ft. 0 in.	0 ft. 1 in.
751 to 15 kV	10 ft. 0 in.	5 ft. 0 in.	2 ft. 2 in.	0 ft. 7 in.
15.1 kV to 36 kV	10 ft. 0 in.	6 ft. 0 in.	2 ft. 7 in.	0 ft. 10 in.
36.1 kV to 46 kV	10 ft. 0 in.	8 ft. 0 in.	2 ft. 9 in.	1 ft. 5 in.
46.1 kV to 72.5 kV	10 ft. 0 in.	8 ft. 0 in.	3 ft. 3 in.	2 ft. 1 in.
72.6 kV to 121 kV	10 ft. 8 in.	8 ft. 0 in.	3 ft. 2 in.	2 ft. 8 in.
138 kV to 145 kV	11 ft. 0 in.	10 ft. 0 in.	3 ft. 7 in.	3 ft. 1 in.
161 kV to 169 kV	11 ft. 8 in.	11 ft. 8 in.	4 ft. 0 in.	3 ft. 6 in.
230 kV to 242 kV	13 ft. 0 in.	13 ft. 0 in.	5 ft. 3 in.	4 ft. 9 in.
345 kV to 362 kV	15 ft. 4 in.	15 ft. 4 in.	8 ft. 6 in.	8 ft. 0 in.
500 kV to 550 kV	19 ft. 0 in.	19 ft. 0 in.	11 ft. 3 in.	10 ft. 9 in.
765 kV to 800 kV	23 ft. 9 in.	23 ft. 9 in.	14 ft. 11 in.	14 ft. 5 in.

Notes:

¹ See Glossary in section XIII for definition of terms.

All dimensions are distance from live part to worker.

For SI Units: 1in = 25.4mm; 1ft = 0.3048m.

For flash protection boundary, see NFPA 70E, 130.3(A)(1).

Column No. 1: The voltage ranges group voltages that require similar approach distances based on the sum of the electrical withstand distance and an inadvertent movement factor. The value of the upper limit for a range is the maximum voltage for highest nominal voltage in the range based on ANSI C84.1-1995, Electric Power systems and equipment—Voltage Ratings (60Hz). For single-phase systems, select the range that is equal to the system’s maximum phase-to-ground voltage times 1.732.

Column No. 2: The distances in this column are based upon OSHA’s rule for unqualified persons to maintain a 10ft (3.05m) clearance for all voltages up to 50kV (voltage-to-ground), plus 0.4in (102mm) for each 1kV over 50kV.

Column No. 3: The distances are based on the following:

- 750V and lower, use NEC Table 110.26(a) Working Clearances, Condition 2 for 151-600V range.
- For voltages over 750V, but not over 145kV, use NEC Table 110.34(a) Working Space, Condition 2.
- For over 145kV, use OSHA’s 10 foot (3.05m) rules as used in Column No. 2.

Column No. 4: The distances are based on adding to the flashover dimensions shown above the following inadvertent movement distance:

- 300V and less, avoid contact, based upon experience and precautions for household 120/240 systems.
- Over 300V and not over 750V, add 1 foot 0 inches inadvertent movement. These values have been found to be adequate over years of use in ANSIC2, National Electrical Safety Code, in the approach distances for communication workers.
- Over 72.5kV, add 1 foot 0 inches inadvertent movement.

These distances have been found to be adequate over years of use in the NESC in the approach distances for supply workers.

Column No. 5: The distances are based on the following:

- 300 and less, avoid contact.
- Over 300 but less than 750V, use clearances from NEC table 230.51(C).
- Between open conductors and surfaces, 600V not exposed to weather.
- Over 750V but not over 2.0kV, value selected that fits in with adjacent values.
- Over 2kV but not over 72.5kV, use NEC Table 490.24, “Minimum Clearance of Live Parts,” outdoor phase-to-ground values.
- Over 72.5kV, add 0 foot 6 inches inadvertent movement.

These values have been found to be adequate over years of use where a hazard/risk analysis, either formal or informal, has been performed of a special work procedure that allows closer approach than that permitted by the restricted approach boundary distance.



E. Flash hazard analysis

A flash hazard analysis must be performed before work can be done on or near exposed circuits that have not been put in an electrically safe work condition.

NFPA 70E section 110.8(B)(1)(b):

A Flash Hazard Analysis shall be done in order to protect personnel from the possibility of being injured by an arc-flash. The analysis shall determine the Flash Protection Boundary and the personal protective equipment that people within the Flash Protection Boundary shall use.

NFPA 70E Flash Protection Boundary definition:

An approach limit at a distance from exposed live parts within which a person could receive a second-degree burn if an electrical arc-flash were to occur.

Because workers might need to work on or near equipment not in an electrically safe work condition, additional safety measures must be taken. Since electrical arcs can seriously burn workers, *NFPA 70E* has adopted procedures to provide safe working distances from a hazardous arc. Whenever work is to be done on or near exposed parts not in an electrically safe work condition within the flash protection boundary (FPB), the worker(s) must wear the proper PPE for the potential arc-flash hazard. Note: this includes testing for absence of voltage while putting a circuit in an electrical safe work condition.

The two variables that have the greatest impact on the amount of energy released during an arcing fault are the available bolted fault current, and the time it takes the overcurrent protective device to clear the fault. Different types of overcurrent protective devices can have opening times that vary greatly. Current-limiting devices will open in less than $\frac{1}{2}$ cycle in their current-limiting range, while devices that incorporate a short-time delay can take up to 30 cycles to open. If not properly maintained, circuit breakers could have unintentionally longer clearing times, resulting in higher hazard levels (for more information see Section X(M)).

Different methods are available for conducting a flash hazard analysis for systems 600V or less. No matter which method of flash hazard analysis is used, certain information is required for a proper assessment. In this publication, three methods are discussed for systems 600V or less:

1. Determine FPB and Hazard Risk Category/PPE Using Tables in *NFPA 70E*
2. Calculate FPB and Incident Energy Using *NFPA 70E* Formulae
- NEW** 3. Determine FPB and Incident Energy Using IEEE 1584

Method 1: Determine FPB and Hazard Risk Category/PPE Using Tables in *NFPA 70E*

(See Example 1 on page 30)

FPB:

If the overcurrent protective device has a clearing time of 6 cycles or less and available fault current of 50kA or less (or any combination where the product of clearing time and available fault current does not exceed 300kA cycles or 5000A-seconds) *70E-130.3(A)(1)* allows a flash protection boundary of 4 feet to be used.

There are equations in *70E-130.3(A)(1)* that can be used to calculate the flash protection boundary. These equations shall be used when the clearing times and bolted fault currents are greater than 300kA cycles, or may be used as an alternative to the 4 feet FPB when under engineering supervision. They are based upon the work outlined in a technical paper by Ralph H. Lee, "The Other Electrical Hazard: Electrical Arc-blast Burns," in *IEEE Transactions on Industrial Applications*, Volume IA-18. No.3, May/June 1982. Either of the following formulae may be used for this calculation.

$$D_c = [2.65 \times MVA_{bf} \times t]^{1/2} \text{ (ft)}$$

or

$$D_c = [53 \times MVA \times t]^{1/2} \text{ (ft)}$$

Where:

D_c = flash protection boundary in feet

MVA_{bf} = bolted 3-phase fault MVA at point involved
= $1.73 \times \text{voltage L-L} \times \text{available short-circuit current} \times 10^{-6}$

MVA = MVA rating of transformer (For transformers with MVA ratings below 0.75 MVA, multiply the transformer MVA rating by 1.25)

t = time of arc exposure in seconds

The first formula is more accurate, since it accounts for conductor impedance in the circuit. Note the two important circuit variables in each equation are available short-circuit current and time of arc exposure. MVA_{bf} is the bolted three-phase short-circuit available expressed in millions of volt-amperes. The other critical variable is time. Energy released in an electrical arc escalates rapidly. The flash protection boundary therefore is dependent on the characteristics of the overcurrent protective device. An overcurrent device should be selected that limits the arc time duration and, if possible, limits the magnitude of the current. When the fault current is within the current-limiting range of current-limiting fuses, the arc-flash hazard is generally reduced. Current-limiting fuse equivalent RMS let-through data (where available) can be used in the flash distance formula. Where data is unavailable, the full available short circuit should be used.



PPE from tables: The flash hazard analysis must also determine the proper PPE. The PPE can be selected by using tables in *NFPA 70E*. It is important to note that several qualifiers to these tables must be satisfied to use the tables. The result is that the over-current protective device opening time, and available fault current, must be known in order to use the tables properly. This point is made in the following:

NFPA 70E section 130.7(C)(9)(a):

For tasks not listed, or for power systems with greater than the assumed short circuit current capacity or with longer than the assumed fault clearing times, a flash hazard analysis is required in accordance with 130.3.

70E-Table 130.7(C)(9)(a) *Hazard Risk Category Classifications* allows users to determine the hazard risk category for a specific work task simply by using this table. The table lists several types of electrical equipment and specific tasks to be performed. The user selects the equipment and task that will be performed and reads across the row to determine the hazard risk category and also whether voltage-rated gloves and/or voltage-rated tools are required. The hazard risk categories are 0, 1, 2, 3, and 4. If the task to be performed is not listed in the tables, or the table qualifiers are not met, the PPE shall be selected by calculating the incident energy (see methods 2 and 3, following).

Once the hazard risk category has been determined, 70E-Table 130.7(C)(10), Protective Clothing and Personal Protective Equipment (PPE) Matrix, can be used to select the required PPE. 70E-Table 130.7(C)(11), Protective Clothing Characteristics, is then used to determine the required minimum arc rating of the PPE. See Example 1 on page 30.

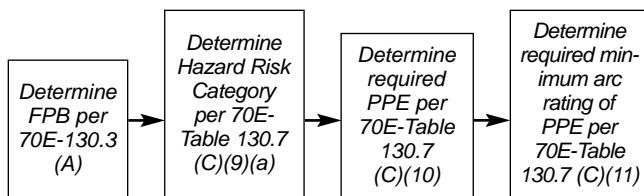

Method 2: Calculate FPB and Incident Energy Using NFPA 70E Formulae

(See Example 2 on page 31.)

FPB: The flash protection boundary is determined using one of the equations in Method 1 discussed previously.

PPE from calculations: With this method, the first step is to determine the thermal energy an arcing fault would release for the specific circumstances, and then determine the PPE. A calculation is made to determine the value for the arc-flash energy release. Typically, what is calculated is the incident energy, which is a thermal energy measurement (calories or joules) over an area (typically centimeter squared) at a distance the workers head and torso would be from the arc. Incident energy is measured in cal/cm² or joules/cm². The industry has generally accepted 18 inches as a typical working distance for calculating the incident energy on low voltage systems. However, it can be calculated at different distances if required. The equation to calculate the incident energy is found in *NFPA 70E* Annex D, D.6.2. The formula is taken from a paper by R.L. Doughty, T.E. Neal, and H.L. Floyd II, "Predicting Incident Energy to Better Manage the Electric Arc Hazard on 600V Power Distribution Systems," Record of Conference Papers, IEEE IAS 45th Annual Petroleum and Chemical Industry Conference, September 28-30, 1998.

$$E_{MB} = 1038.7D_B^{-1.4738}t_A [0.0093F^2 - 0.3453F + 5.9675]$$

Where:

- E_{MB} = incident energy, cal/cm²
- D_B = distance, inches (for distances ≥ 18 inches)
- t_A = arc duration, in seconds
- F = bolted fault, short-circuit current, kA (16-50kA)

Note: The formula is applicable for a range of 16kA to 50kA short-circuit current.

Just as with the flash protection boundary equation, the incident energy is also a function of the available fault current and the time it takes the overcurrent protective device to clear the fault. Equivalent RMS let-through data, (where available) can be used in the incident energy formula. Where data is unavailable, the full available short circuit should be used. This incident energy will determine the required minimum arc rating of the PPE. The calculated incident energy then can be used to determine the hazard risk category from 70E-Table 130.7(C)(11), and the actual PPE required is found in 70E-Table 130.7(C)(10).



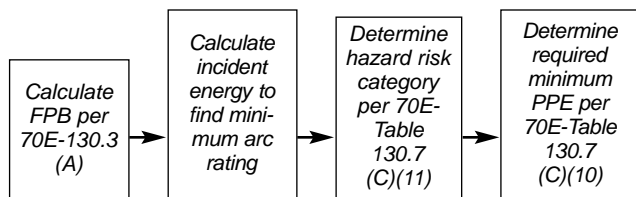

Method 3: Determine FPB and Incident Energy Using IEEE 1584

(See Example 3 on page 33.)

This is a newer method that is included in *NFPA 70E*, Annex D. It is IEEE 1584 *Guide for Performing Arc-flash Hazard Calculations*. IEEE 1584 used extensive testing and analysis to develop new formulae for doing a flash hazard analysis. IEEE 1584 has several calculation alternatives.

IEEE 1584 simplified method: IEEE developed formulae to calculate incident energy for current-limiting fuses and low-voltage circuit breakers. These equations allow the incident energy to be calculated directly from the available three-phase bolted fault current on a 480V system if the type and ampere rating of overcurrent protective device is known. This simplified method does not require the availability of time current curves for the devices. The **fuse formulae** are based on actual arc-flash test data using Bussmann® LOW-PEAK® fuses. The circuit breaker formulae were developed by analyzing typical circuit breaker operation and calculated arcing currents. Because there are several equations dependent on the type, and size of the overcurrent protective device and range of fault currents, the equations are not reprinted here. These equations can be found in IEEE 1584 Sections 5.6 and 5.7 and in D.8.6 in *NFPA 70E*, Annex D.

For convenience, the incident energy and flash protection boundaries for LOW-PEAK® fuses and circuit breakers, based on IEEE 1584, have been presented in an easy-to-use tabular format in Annex G of this book. This table makes it simple to find the incident energy and flash protection boundary based on the available three-phase bolted fault current at 480V and the type of overcurrent protective device. This information is also available using an interactive online calculator at www.bussmann.com.

The notes in Annex G should be read before using the table in Annex G. The calculations in this table were created so that the PPE selected from the calculated incident energy would be adequate for 98% of arc-flash incidents. In up to 2 percent of incidents, the level of PPE may be one level too low. For IEEE 1584, the set of PPE arc ratings were chosen as 1.2, 8, 25, 40, and 100cal/cm². For incident energy results that fall between these values, PPE with the next higher standard arc rating must be used. For instance if the incident energy is calculated to be 11cal/cm², the PPE used must have a 25cal/cm² arc rating. PPE with

intermediate arc ratings can be utilized per this method, but at the next lower arc rating. If intermediate arc ratings are not utilized at the next lower arc rating, there is a higher probability that the PPE will not be adequate for an arc-flash incident.

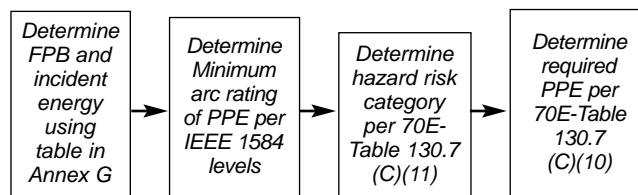

IEEE 1584 other methods: Using IEEE 1584, the arcing fault current is calculated based on the available bolted fault current and then the arcing current is used to determine the opening time of the overcurrent protective device. Using this opening time and the arcing current, the incident energy is calculated using formulae. IEEE 1584 uses the incident energy to calculate a flash protection boundary.

Summary on flash hazard analysis

Methods 1, 2, and 3 are acceptable ways to conduct the flash hazard analysis. With each method the available three-phase bolted fault current must be known. If the available bolted fault current is not known, it must be calculated before performing a flash hazard analysis. With methods 1 and 2, the opening time of the overcurrent protective device must be known. Although different analysis methods are likely to provide different results, the requirement is that *some* method be used to enable a worker to select arc rated PPE. An employer should select one method to assess the arc-flash hazard. The selection should be based on the overall work environment at the work site. The desired result of the analysis, regardless of which method is chosen, is that a worker must be able to select flame-resistant PPE. One factor directly associated with the selection is that workers must understand the procedure, and supervisors must be able to administer it. The most important issue is that workers wear PPE that has an adequate arc rating and that all exposed body parts within the flash protection boundary are covered by arc rated, flame-resistant material. The idea is to consider the following elements and then identify a safe working distance to avoid an arc-flash injury.

- Available three-phase bolted fault current
- Current that is “let-through” by the overcurrent device (if current-limiting)
- Length of time the fault current is permitted to flow

If the skin’s surface is covered with clothing, the analysis objective changes. In this situation, the objective is to avoid ignition or breakopen of the clothing material. Should the apparel be ignited, the exposure time to a very high temperature is much greater. Clothing must not add to the degree of the injury.



The following example provides some insight into typical situations:

Example 1 Using Method 1 - FPB and Hazard/Risk Category/PPE Tables in NFPA 70E:

Use Method 1 to determine the flash protection boundary and required PPE to perform voltage testing on a 480V motor control center (MCC). The available three-phase bolted fault current is 18,000A. The opening time of the feeder overcurrent protective device upstream from the MCC is 1 cycle (0.0167 seconds).

The flash protection boundary must be established. The combination of available bolted fault current and the device clearing time is 18kA cycles (<300kA cycles); therefore 4.0 feet can be used as the flash protection boundary.

Next, find the correct heading in 70E-Table 130.7(C)(9)(a) (excerpts are printed below), which is

600V Class Motor Control Centers (MCCs). Notice the references to Notes 2 and 3. These notes must be checked to verify that the qualifications are met. If the qualifications are not met, the table cannot be used, and a calculation method shall be used. Note 2 states an assumed short-circuit current of 65kA, and an assumed fault clearing time of 0.03 seconds (2 cycles). Note 3 allows the Hazard/Risk Category to be reduced by one number if the available fault current is below 10kA. With 18,000A available and a 1-cycle clearing time, we are within the limits of the assumed short-circuit current and fault clearing time; therefore the table can be used, but the Hazard/Risk Category cannot be reduced.

Excerpts from Hazard Risk Category Classifications (NFPA 70E Table 130.7(C)(9)(a))

Task (Assumes Equipment is Energized, and Work Is Done Within the Flash Protection Boundary)	Hazard/ Risk Category	V-rated Gloves	V-rated Tools
Panelboards rated 240V and below - Notes 1 and 3	—	—	—
•	•	•	•
•	•	•	•
•	•	•	•
600V Class Motor Control Centers (MCCs) — Notes 2 (except as indicated) and 3	—	—	—
•	•	•	•
•	•	•	•
•	•	•	•
CB or fused switch or starter operation with enclosure doors open	1	N	N
Work on energized parts, including voltage testing	2*	Y	Y
Work on control circuits with energized parts 120V or below, exposed	0	Y	Y
•	•	•	•
•	•	•	•
•	•	•	•

Legend:

V-rated Gloves are gloves rated and tested for the maximum line-to-line voltage upon which work will be done.

V-rated Tools are tools rated and tested for the maximum line-to-line voltage upon which work will be done.

2* means that a double-layer switching hood and hearing protection are required for this task in addition to the other Hazard/Risk Category 2 requirements of Table 130.7(C)(10).

Y = yes (required)

N = no (not required)

Notes:

- 25kA short circuit current available, 0.03 second (2 cycle) fault clearing time.
- 65kA short circuit current available, 0.03 second (2 cycle) fault clearing time.
- For <10kA short circuit current available, the Hazard/Risk Category required may be reduced by one number.
- 65kA short circuit current available, 0.33 second (20 cycle) fault clearing time.
- 65kA short circuit current available, up to 1.0 second (60 cycle) fault clearing time.
- For <25kA short circuit current available, the Hazard/Risk Category required may be reduced by one number.



Once it is verified that the table can be used, the task is selected under the equipment heading. In this case, work on energized parts, including voltage testing. The Hazard/Risk Category for this task is 2*, and V-rated Gloves and Tools are required (denoted by 'Y' in those columns). The legend explains that 2* means that a double-layer switching hood and hearing protection are required for this task in addition to the other Hazard/Risk Category 2 requirements of 70E-Table 130.7(C)(10).

70E-Table 130.7(C)(10) Protective Clothing and Personal Protective Equipment (PPE) Matrix requires the following equipment for Category 2. This table also has a legend and Notes that should be referenced. (After this listing are the applicable notes.):

Non-melting (according to ASTM F 1506-00) or Untreated Natural Fiber

- T-shirt (short-sleeve)
- Pants (long) (Note 6)

FR Clothing (Note 1)

- Long-sleeve shirt
- Pants (Note 6) - Alternate is to use FR coveralls (minimum arc rating of 4) over non-melting or untreated natural fiber pants and T-shirt.

FR Protective Equipment

- Hard hat
- Safety glasses or safety goggles
- Flash suit hood (face shield is not allowed because of the 2* requirement from 70E-Table 130.7(C)(9)(a))
- Hearing protection (ear canal inserts) (Note 8)
- Leather gloves (Note 2)
- Leather work shoes

NFPA 70E Table 130.7(C)(10) Notes:

1. See Table 130.7(C)(11). Arc rating for a garment is expressed in cal/cm².
2. If voltage-rated gloves are required, the leather protectors worn external to the rubber gloves satisfy this requirement.
6. If the FR pants have a minimum arc rating of 8, long pants of non-melting or untreated natural fiber are not required beneath the FR pants.
7. Alternate is to use FR coveralls (minimum arc rating of 4) over non-melting or untreated natural fiber pants and T-shirt.
8. A faceshield with a minimum arc rating of 8, with wrap-around guarding to protect not only the face, but also the forehead, ears, and neck (or, alternatively, a flash suit hood), is required.

Finally, since the hazard/risk category is 2*, 70E-Table 130.7(C)(11) (see page 35) requires all PPE for this work task to have a minimum arc rating of 8cal/cm².

The minimum requirement is that qualified persons within 4.0 feet of exposed energized parts for this task shall wear an untreated cotton T-shirt, 8cal/cm² long-sleeve shirt, 8cal/cm² long pants, hard hat, safety glasses, 8cal/cm² flash hood, hearing protection, Class 00 insulating gloves and leather protectors. Substitutions are allowed in accordance with *NFPA 70E*. 1000V rated insulated tools are also required. Unqualified persons shall not enter the flash protection boundary.

Example 2 Using Method 2:

Calculate FBP and incident energy - *NFPA 70E*
 Formulae: Use Method 2 to determine the flash protection boundary and required PPE for the circuit from Tests 4 and 3 shown in Section VI. The available three-phase bolted fault current is 22,600A at 480V. Because it is possible to initiate a fault on the line side of the branch-circuit short-circuit device inside the combination motor starter, the device that is upstream must be used for the flash hazard analysis

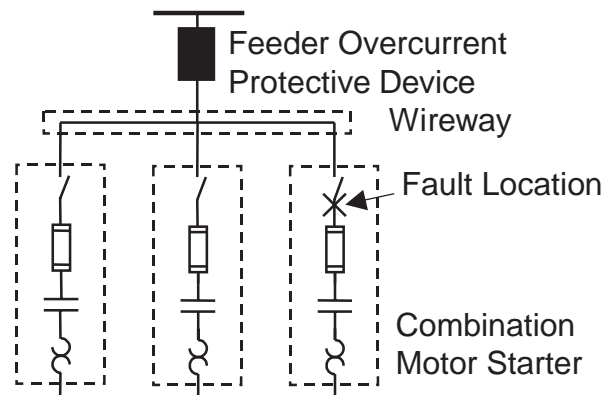

Test 4: 640A Circuit Breaker Protecting a Feeder

The feeder overcurrent protective device from Test 4 was a 640A circuit breaker with short-time delay (STD); the fault current was permitted to follow for 6 cycles.

First calculate the flash protection boundary using 22,600A available bolted fault current, and 0.1 second device opening time (6 cycles):

$$D_c = [2.65 \times MVA_{bf} \times t]^{1/2} \text{ (ft)}$$

$$D_c = [2.65 \times 1.732 \times 480 \times 22,600 \times 10^{-6} \times 0.1]^{1/2} \text{ (ft)}$$

$$D_c = (4.98)^{1/2} \text{ (ft)}$$

$$D_c = 2.23 \text{ ft}^\dagger \text{ Flash Protection Boundary}$$



Next calculate the incident energy at 18 inches:

$$E_{MB} = 1038.7D_B^{-1.4738}t_A [0.0093F^2 - 0.3453F + 5.9675] \text{ (cal/cm}^2\text{)}$$

$$E_{MB} = 1038.7(18)^{-1.4738}(.1) [0.0093(22.6)^2 - 0.3453(22.6) + 5.9675] \text{ (cal/cm}^2\text{)}$$

$$E_{MB} = 4.27\text{cal/cm}^2 \text{ Incident Energy at 18 inches}$$

†If the circuit breaker has not been maintained properly, the incident energy and flash protection boundary may be much greater.

This is a Category 2 hazard level per 70E-Table 130.7(C)(11). 70E-Table 130.7(C)(10) Protective Clothing and Personal Protective Equipment (PPE) Matrix requires the following equipment for Category 2:

Non-melting (according to ASTM F 1506-00) or Untreated Natural Fiber

- T-shirt (short-sleeve)
- Pants (long) (Note 6)

FR Clothing (Note 1)

- Long-sleeve shirt
- Pants (Note 6) - Alternate is to use FR coveralls (minimum arc rating of 4) over non-melting or untreated natural fiber pants and T-shirt.

FR Protective Equipment

- Hard hat
- Safety glasses or safety goggles
- Arc-rated face shield, or flash suit hood (Note 8)
- Hearing protection (ear canal inserts) (Note 8)
- Leather gloves (Note 2)
- Leather work shoes

The minimum requirement is that qualified persons within 2.23 feet of exposed energized parts shall wear an untreated cotton T-shirt, 5cal/cm² long-sleeve shirt, 5cal/cm² long pants, hard hat, safety glasses, 5cal/cm² arc-rated face shield, hearing protection, Class 00 insulating gloves and leather protectors. Substitutions are allowed in accordance with *NFPA 70E* (see table notes in Example 1). 1000V rated insulated tools are also required. Unqualified persons shall not enter the flash protection boundary.

Test 3: KRP-C-601SP LOW-PEAK® Fuses Protecting a Feeder

The feeder overcurrent protective device from Test 3 was a KRP-C-601SP current-limiting fuse (Class L). For 22,600A available bolted fault current, the KRP-C-601SP will let-through 11,000A (to learn how to determine let-through, current consult The

SPD - Electrical Protection Handbook available at www.bussmann.com). The KRP-C-601SP cleared the fault in ½ cycle (0.008 seconds). The flash protection boundary is:

$$D_c = [2.65 \times MVA_{bf} \times t]^{1/2} \text{ (ft)}$$

$$D_c = [2.65 \times 1.732 \times 480 \times 11,000 \times 10^{-6} \times 0.008]^{1/2} \text{ (ft)}$$

$$D_c = (0.19)^{1/2} \text{ (ft)}$$

$$D_c = 0.44 \text{ ft flash protection boundary}$$

It is recommended to use a minimum flash protection boundary of 0.5 feet (6 inches).

Next calculate the incident energy at 18 inches:

$$E_{MB} = 1038.7D_B^{-1.4738}t_A [0.0093F^2 - 0.3453F + 5.9675] \text{ (cal/cm}^2\text{)}$$

$$E_{MB} = 1038.7(18)^{-1.4738}(.008) [0.0093(16)^2 - 0.3453(16) + 5.9675] \text{ (cal/cm}^2\text{)}$$

$$E_{MB} = 0.33 \text{ cal/cm}^2 \text{ Incident Energy at 18 inches}$$

Note: *Even though the let-through current is only 11kA, 16kA is entered because it is the minimum applicable fault current for the equation.*

The calculated incident energy is below the second-degree burn threshold of 1.2cal/cm². This is a Category 0 hazard level in 70E-Table 130.7(C)(11). 70E-Table 130.7(C)(10) Protective Clothing and Personal Protective Equipment (PPE) Matrix requires the following equipment for Category 0:

Non-melting (according to ASTM F 1506-00) or Untreated Natural Fiber

- Shirt (long-sleeve)
- Pants (long)

FR Protective Equipment

- Safety glasses

The minimum requirement is that qualified persons within 0.44 feet of exposed energized parts shall wear an untreated cotton long-sleeve shirt and long pants, and safety glasses. Class 00 insulating gloves and leather protectors, and 1000V rated insulated tools may also be required to protect the worker from a potential shock hazard. It is recommended to use 6 inches as a minimum flash protection boundary. The use of Class 00 insulating gloves and leather protectors while working on or near energized parts is recommended as the best way to protect the workers hands from arcing events.

This example illustrates the tremendous impact the type of overcurrent protective device can have on the hazard level for a given circuit. By limiting the magnitude of the available fault current and clearing the fault within ½ cycle, the LOW-PEAK® KRP-C-601SP current-limiting fuse (Class L) was able to significantly reduce the level of energy in this case.



Example 3 Using Method 3:

Determine FPB and Incident Energy - IEEE 1584: Use Method 3 to determine the flash protection boundary and incident energy on the following 480V circuit:

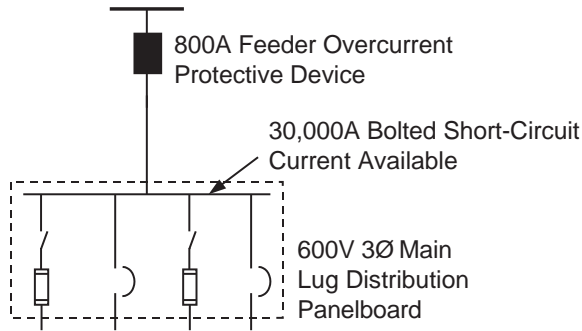

The available bolted fault current is 30,000A at the main lugs of the distribution panelboard. Calculate the flash protection boundary and incident energy for a LOW-PEAK® KRP-C-800SP current-limiting fuse (Class L) feeding the distribution panelboard, and also for an 800A low voltage power circuit breaker with short-time delay feeding the panelboard.

Use *Arc-flash Incident Energy Calculator* in Annex G (an excerpt from the table follows). Find the amps rating and type of overcurrent protective device in the header of the table. Select the available bolted fault current from the left column.

Excerpts From Arc-flash Incident Energy Calculator (Full table is found in Annex G)

Arc-flash Incident Energy Calculator									
Fuses: Bussmann® LOW-PEAK® KRP-C_SP (601-2000A), Circuit Breakers: Low Voltage Power Circuit Breakers (w/STD)									
Incident Energy (I.E.) values are expressed in cal/cm². Flash Protection Boundary (FPB) values are expressed in inches.									
Bolted Fault Current (kA)	601-800A		801-1200A		1201-1600A		1601-2000A		
	Fuse	LVPCB	Fuse	LVPCB	Fuse	LVPCB	Fuse	LVPCB	
	I.E.	FPB	I.E.	FPB	I.E.	FPB	I.E.	FPB	I.E.
1	>100	>120	>100	>120	>100	>120	>100	>120	>100
2	>100	>120	>100	>120	>100	>120	>100	>120	>100
3	>100	>120	>100	>120	>100	>120	>100	>120	>100
•	•	•	•	•	•	•	•	•	•
•	•	•	•	•	•	•	•	•	•
26	1.34	19	50.35	>120	7.52	63	50.35	>120	23.08
28	1.22	18	54.18	>120	6.28	55	54.18	>120	22.71
30	1.10	17	58.01	>120	5.16	48	58.01	>120	22.34
32	0.98	16	61.83	>120	4.15	42	61.83	>120	21.69
34	0.86	14	65.66	>120	3.25	35	65.66	>120	18.59
•	•	•	•	•	•	•	•	•	•
•	•	•	•	•	•	•	•	•	•



KRP-C-800SP Fuse

Incident Energy = 1.1cal/cm²

Flash Protection Boundary = 1ft 5in

800A LVPCB w/STD

Incident Energy = 58.01cal/cm²†

Flash Protection Boundary >10 ft†

†If the circuit breaker has not been maintained properly, the incident energy and flash protection may be much greater

For the KRP-C-800SP Fuse:

The calculated incident energy is below the second-degree burn threshold of 1.2cal/cm². This is a Category 0 hazard level in 70E-Table 130.7(C)(11). 70E-Table 130.7(C)(10) Protective Clothing and Personal Protective Equipment (PPE) Matrix requires the following equipment for Category 0:

Non-melting (according to ASTM F 1506-00) or Untreated Natural Fiber

- Shirt (long-sleeve)
- Pants (long)

FR Protective Equipment

- Safety glasses

The minimum requirement is that qualified persons within 1 foot 5 inches of exposed energized parts shall wear an untreated cotton long-sleeve shirt and long pants, and safety glasses. Class 00 insulating gloves and leather protectors, and 1000V insulated tools may also be required to protect the worker from a potential shock hazard. It is recommended to use Class 00 insulating gloves and leather protectors while working on or near energized parts as the best way to protect the workers hands from arcing events.

For the 800 A LVPCB w/STD:

While PPE manufacturers make flash suits with arc ratings up to 100cal/cm², *NFPA 70E* does not have a Hazard Risk Category for incident energies above 40cal/cm². Working on energized circuits with energy levels in excess of 40cal/cm² should be avoided by all means necessary. If energized work must be performed on these circuits, steps should be taken to reduce the hazard before the work is to be performed. For more information about designing safer systems, or upgrading existing systems see Section X.

Arcing fault currents in the long time characteristic of overcurrent protective devices

In many electrical fault analysis studies the focus is only on the circuits with the highest or worst case short-circuit currents. However, in flash hazard analysis, it is important to also investigate circuits where the arcing fault current may be a value that is less than a circuit breaker's instantaneous trip setting

(resulting in an opening time of up to several seconds) or may be a value that takes a fuse several seconds to open. On lower-amps-rated circuits, this is not typically a problem for several reasons. However, on larger-amps-rated circuits (over 1200A) this can become more of an issue. For some higher amps rating overcurrent protective devices, the incident energy and flash protection boundaries are extremely large for some lower fault currents. Workers also must consider examining the flash protection boundary and incident energy for circuits with low levels of arcing current. Some lower-level arcing faults are not able to sustain themselves; however, there is not much recent research in this area. In those cases where a low-level arcing fault is sustained, extended clearing times can produce extremely high incident energy levels.

Other considerations

Consideration should also be given for how long a worker could be exposed to an arc, based upon the location of the worker.

IEEE 1584 Annex B

If the time is longer than two seconds, consider how long a person is likely to remain in the location of the arc-flash. It is likely that a person exposed to an arc-flash will move away quickly if it is physically possible, and two seconds is a reasonable maximum time for calculations. A person in a bucket truck, or a person who has crawled into equipment will need more time to move away.

For example, is the worker standing in front of the switchboard with plenty of clearance, or is he/she kneeling or lying down in front of the gear? Is the worker on the ground or up in a bucket working on a bus duct? Can the worker easily escape the room or could he or she become trapped in the vault?

NFPA 70E and *IEEE 1584* have developed some good tools for assessing the arc-flash hazard and the efforts in this area continue. However, the industry does not presently have tools to assess the arc-blast hazard. Generally, as the risk of the arc-flash energy increases, the risk of the arc-blast energy increases too.

Even though electrical equipment may have a main overcurrent device and disconnecting means, if it is possible to create a fault on the line side of the main, the opening time and let-through characteristics of the overcurrent protective device which feeds the main device should be considered. For example an industrial machine that has a main fusible disconnect switch or circuit breaker fed by a bus plug. When the machine doors are open, it is possible to initiate a fault on the line terminals of the fused switch or circuit breaker, therefore the device in the bus plug must be considered for the flash hazard analysis.



In test labs, arcing fault current magnitudes can vary widely from test to test, even under the same test circumstances. The industry has learned a great deal in the past decade, but there is still a great deal more to be learned. The methods that have been developed from actual testing can be used with a degree of confidence. However, the actual arcing fault currents can vary based on many variables. This can affect the speed of response of the overcurrent protective device supplying the circuit. Some overcurrent protective devices may not operate as intended or specified if periodic maintenance has not been performed. The more one knows about arcing faults, the more one understands that the best strategy in electrical safety is avoidance. Strive to only work on or near exposed conductors that have been placed in an electrically safe work condition.

F. Personal protective equipment (PPE)

OSHA and *NFPA 70E* recognize that, on occasion, electrical work must be performed while the equipment or circuit is energized. Effective procedures, PPE, and personnel training are key elements for executing live work without injury. These issues must be considered when designing electrical systems.

NFPA 70E requires that any body part within the flash protection boundary area be protected, using appropriate PPE. The OSHA standards for various types of PPE are provided in Annex C, Table XIV(B). *NFPA 70E* identifies PPE that should be worn in 70E-130.7.

70E-Tables 130.7(C)(10) and 130.7(C)(11) are used together to properly select the PPE required for working on or near energized parts. 70E-Table 130.7(C)(10) lists the specific PPE items that are required for a given Hazard Risk Category. 70E-Table 130.7(C)(11) (that follows) identifies the required minimum arc rating of the PPE required in each Hazard Risk Category.

***NFPA 70E*, Table 130.7(C)(11) Protective Clothing Characteristics**

Typical Protective Clothing Systems		
Hazard Risk Category	Clothing Description (Typical number of clothing layers is given in parentheses)	Required Minimum Arc Rating of PPE Joules/cm ² (cal/cm ²)
0	Non-melting, flammable materials (i.e., untreated cotton, wool, rayon, or silk, or blends of these materials) with a fabric weight at least 4.5oz/yd ² (1)	N/A
1	FR shirt and FR pants or FR coverall (1)	16.74 (4)
2	Cotton underwear - conventional short sleeve and brief/shorts, plus FR shirt and FR pants (1 or 2)	33.47 (8)
3	Cotton underwear plus FR shirt and FR pants plus FR coverall, or cotton underwear plus two FR coveralls (2 or 3)	104.6 (25)
4	Cotton underwear plus FR shirt and FR pants plus multi-layer flash suit (3, or more)	167.36 (40)

Note: Arc Rating is defined in Article 100 and can be either ATPV or EBT. ATPV is defined in ASTM F 1959-99 as the incident energy on a fabric or material that results in sufficient heat transfer through the fabric or material to cause the onset of a second-degree burn based on the Stoll curve. EBT is defined in ASTM F 1959-99 as the average of the five highest incident energy exposure values below the Stoll curve where the specimens do not exhibit breakopen. EBT is reported when ATPV cannot be measured due to FR fabric breakopen.

The following table shows some typical articles of clothing and PPE required for each Hazard Risk Category. This is to illustrate the type of equipment that may be required to work on energized circuits. It is not intended to be used to select PPE. *NFPA 70E* should be consulted for specific information on selecting appropriate PPE. Layering of FR clothing and protective equipment may provide a higher level of arc-flash protection. *NFPA 70E* has more information on layering of protective clothing and substitutions permitted by layering. Although not required or mentioned in any standards, one might consider wearing a more protective arc rated face shield rather than just safety glasses even for all 0 and 1 hazard risk category tasks. Facial disfigurements are among those injuries that are extremely difficult to overcome from a social prospective.



Typical Protective Clothing and PPE

[Information compiled from Tables 70E-130.7(C)(10) and 70E-130.7(C)(11)]

Category	Minimum Arc Rating (cal/cm ²)	Non-melting or Untreated Natural Fiber Clothing	FR Clothing (Note 1)	FR Equipment (Note 1)
0	N/A	Long-sleeve shirt Long pants		Safety glasses
1	4	T-shirt Long pants	Long-sleeve shirt Long pants	Hard hat Safety glasses
2	8	T-shirt Long pants	Long-sleeve shirt Long pants	Hard hat Safety glasses or goggles Arc-rated face shield ^{††} Hearing protection Leather gloves Leather work shoes
3	25	T-shirt Long pants	Long-sleeve shirt Long pants	Hard hat Safety glasses or goggles Flash suit hood Hearing protection Leather gloves Leather work shoes
4	40	T-shirt Long pants	Long-sleeve shirt Long pants	Flash suit jacket (multi-layer) Flash suit pants Hard hat Safety glasses or goggles Flash suit hood Hearing protection Leather gloves Leather work shoes

^{††} - A category 2* requires a flash suit hood instead of an arc-rated face shield.

Note 1: Substitutions may be allowable per 70E-Table 130.7(C)(10). For more information consult *NFPA 70E*.

Any body part extended within the appropriate risk boundary must be protected from the hazard(s) existing within that boundary. If a hand is within the flash protection boundary, then the hand must be protected by PPE. If a person's head is within the flash protection boundary, the head must be protected. Unless the electrical equipment is placed into an electrically safe work condition, locked out, tagged, and tested for voltage according to proper procedures, the system must be considered energized, requiring that appropriate PPE be used.

NFPA 70E also makes it clear [70E-130.6(D) and 70E-130.6(E)] that conductive materials, tools and equipment that are in contact with any part of an employee's body be handled in a manner that prevents accidental contact with exposed energized conductors or circuit parts. This includes articles of jewelry such as rings, conductive watchbands and metal frame glasses. In most instances, wearing flame-resistant clothing continuously is an effective safety measure for personnel who are frequently exposed or potentially exposed to arc-flash.

OSHA 1910.335 (a)(1)(i)

Employees working in areas where there are potential electrical hazards shall be protected with, and shall use, electrical protective equipment that is appropriate for the specific parts of the body to be protected and for the work to be performed.

Proper care and use of PPE is an important part of any electrical safety program. PPE should be inspected before every usage. PPE should be maintained in accordance with manufacturer's recommendations and the requirements contained in the Tables XIV(C)(1) and XIV(C)(2) in Annex C. Improper care of PPE can cause the equipment to lose its protective properties. For example, rubber goods can lose some of their insulating properties if not properly stored and protected from corrosive materials. Rubber goods may require periodic dielectric testing to verify the insulating capabilities. FR clothing may require special care during laundering and may need to be replaced if torn or if fabric becomes worn after prolonged usage.



G. Lockout/Tagout

OSHA 1910.147-Procedure for applying the Lock/Tag

The Lockout/Tagout Standard has been in effect since 1989. It was created to help reduce the death and injury rate caused by the unexpected energization or start-up of machines or the release of stored energy. Normal production operations, cords and plugs under exclusive control, and hot tap operations are not covered. This standard applies to energy sources such as electrical, mechanical, hydraulic, chemical, nuclear, and thermal.

Lockout is the placement of a key or combination lock on an energy isolation device (disconnect switch, circuit breaker, etc.) to ensure that the energy-isolating device and equipment being controlled cannot be operated until the lockout device is removed. Lockout devices hold an energy-isolating device in a safe position and prevent the energization of a machine or equipment. The lockout device must be substantial enough to prevent removal without use of excessive force or unusual techniques.

If the lockout/tagout includes working on or near exposed de-energized electrical parts (not yet in an electrically safe work condition) then OSHA 1910.333(b)(2) Note 2 shall also apply:

OSHA 1910.333(b)(2) Note 2

Lockout and tagging procedures that comply with paragraphs (c) through (f) of 1910.147 will also be deemed to comply with paragraph (b)(2) of this section provided that:

- (1) The procedures address the electrical safety hazards covered by this Subpart; and*
- (2) The procedures also incorporate the requirements of paragraphs (b)(2)(iii)(D) and (b)(2)(iv)(B) of this section.*

1910.333(b)(2)(iii)(D) requires if a tag is used without a lock, then the tag shall be supplemented with at least one additional safety measure that provides a level of safety equivalent to a lock.

1910.333(b)(2)(iv)(B) requires the testing for the **absence of voltage** on any equipment in which electrical circuit parts may be exposed to workers.

Tagout is the placement of a tag or other prominent warning device and a means of attachment on an energy-isolating device to indicate that the energy-isolating device and the equipment being controlled may not be operated until the tagout device is removed. Tagout devices shall be non-reusable, attached by hand, self-locking, and non-releasing, with a minimum unlocking strength of no less than 50 pounds. They at least must be equivalent to an all-environment tolerant nylon cable tie.

Lockout devices must be used unless the employer can demonstrate that the use of a tagout system can provide full employee protection.

Applying the Lock/Tag

Step 1 — Understand the Hazards before the Shutdown:

Before an authorized or affected employee turns off machinery or equipment, he or she should have knowledge of the type and magnitude of energy, the hazards of the energy to be controlled, and the method or means to control the energy. It might be helpful to have floor drawings, single-line diagrams, and the assistance of the facility electrician and employees who work with the equipment.

Step 2 — Power Down: The machine or equipment shall be turned off or shut down in an orderly manner, using established procedures.

Step 3 — Isolate the Power Source: All energy-isolating devices that are needed to control the energy to the machine or equipment shall be physically located and operated in such a manner as to isolate the machine or equipment from the energy source(s). This might involve such tasks as flipping a power switch, breaking a circuit, and closing a valve. If the equipment has more than one shutdown point, the worker must be sure that all are isolated from power.

Step 4 — Apply the Lock and/or Tag: Lockout or tagout devices shall be affixed to each energy-isolating device by authorized personnel. Lockout devices, where used, shall be affixed in a manner that holds the energy-isolating devices in a “safe” or “off” position. Tagout devices, where used, shall be affixed in a way that clearly indicates that operation or movement of energy isolating devices from the “safe” or “off” position is prohibited.

Additional requirements for electrical lockout/tagout (OSHA 1910.333(b)(2) Note 2):

Step 4A- If there are exposed electrical parts and only tagout is used, then another additional measure shall be used that provides a level of safety equivalent to a lock.

Step 4B- If there are exposed electrical parts, then using the **appropriate PPE and other safety measures**, a worker must **verify the absence of voltage**.



Step 5 — Release Residual Energy: Following the application of lockout/tagout devices, all potentially hazardous stored or residual energy shall be relieved, disconnected, restrained, and otherwise rendered safe. If a possibility of reaccumulation of stored energy to a hazardous level exists, verification of isolation shall be continued until the servicing or maintenance is completed, or until the possibility of such accumulation no longer exists.

Step 6 — Try to Power Up: Before starting work on machines or equipment that have been locked out or tagged out, authorized personnel shall verify that isolation and de-energization of the machine or equipment has been accomplished. This requires personnel to turn all controls of the equipment or machinery in the “on” position to ensure that all energy sources have been isolated and that the equipment does not start up while work is being performed on it. Before trying to power up, the worker must be sure that no one is near the equipment or machinery in case the equipment continues to have power. Lastly, the employee should verify that the isolation point cannot be moved to the “on” position. The employee then can continue servicing or maintaining the equipment.

Removing the lock/tag

Step 1 — Inspect the Machine and/or Equipment: The work area shall be inspected to ensure that all nonessential items (e.g., tools, spare parts, debris) have been removed, and that machine or equipment components are operationally intact.

Step 2 — Notify Personnel: All personnel in the vicinity shall be notified before removal of the lockout and start up. The person in charge of the lockout/tagout shall ensure that no one is in the way of possible danger upon start up.

Step 3 — Remove the Lockout/Tagout Device: Each lockout/tagout device should be removed by the person who placed it. When more than one person has applied a lock, the last person to remove his or her lock should remove the hasp or other multiple lock device. When all locks have been removed and the machine/equipment is determined to be operating safely, other personnel may be notified that the equipment is now operational.

H. Stored energy systems

Simply because the electrical circuit has been opened might not mean the system is safe to work on. The following cautions should be understood:

- Capacitors can store hazardous energy even after the equipment has been de-energized and can build up a dangerous residual charge without an external source.

- Capacitors also can be used to store large amounts of energy. An internal failure of one capacitor in a bank frequently results in an explosion when all other capacitors in the bank discharge into the fault.
- High-voltage cables should be treated as capacitors because they have capacitance and thus can store energy.

I. IP2X (finger-safe) ratings

NFPA 70E requires that a guard be used to prevent access to voltages above 50V. Guarding and the installation of insulating barriers must be complete if work is to be performed while the equipment is energized.

Note: *The placement of barriers might effectively protect personnel from shock hazards but might not protect personnel from arc-flash hazards. Therefore, placement of barriers might reduce the chance for electrical shock but does not always eliminate the requirements of flash protection if the task involves work inside the flash hazard boundary.*

Guarding, however, also might prevent accidental contact by tools and other conductive materials that could cause an arc-flash. A practical approach to providing these guards would be to adopt standards that address this issue. IEC 60204-1 is entitled “Electrical Equipment Used in Industrial Machines.” Section 6 of the standard refers to the requirements for protecting people against electrical shock. In general, electrical equipment must provide protection against people coming into direct or indirect contact with energized electrical parts within an enclosure.

When a person is working in an enclosure with energized components, the standard requires the worker to be protected against contact to at least IP1X (the letter “X” here is used in place of the second number to indicate that tests for ingress of liquid is neither required nor applicable). The worker must be protected from direct contact with live parts that could be touched easily while resetting, adjusting, or replacing nearby components to at least an IP2X rating.



CODE LETTERS	1	2	3
International Protection			
FIRST NUMBER Protection against Solid objects (0 – 6)			
0 -- no protection			
1 -- 50mm (hand)			
2 -- 12mm (finger)			
3 -- 2.5mm (tools & wire)			
4 -- 1mm (small tools & small wires)			
5 -- dust (no harmful deposits)			
6 -- total protection against dust			
SECOND NUMBER Protection against Liquids (0 – 7)			
0 -- no protection			
1 -- vertically falling rain			
2 -- direct spray of water (up to 15° from vertical)			
3 -- spray to 60° from vertical			
4 -- water sprayed from all directions			
5 -- low pressure jets of water from all directions			
6 -- strong jets of water (ship decks)			
7 -- immersion between 15cm and 1m			
THIRD NUMBER (Optional) Protection against mechanical impact			
0 -- no protection			
1 -- impact 0.225 joule 150g falling from 15cm			
2 -- impact 0.375 joule 250g falling from 15cm			
3 -- impact 0.50 joule 250g falling from 20cm			
5 -- impact 2.00 joule 500g falling from 40cm			
7 -- impact 6.00 joule 1.5kg falling from 40cm			
9 -- impact 20.00 joule 5kg falling from 40cm			

Figure IX(I). IP Environmental Ratings for Enclosures (IEC 529)

Note: The terminology used for this program includes the term *finger-safe* for any product with an IP2X designation. IP20 rated products represent products with no protection against liquids.

IP2X is often referred to as “finger-safe,” meaning that a probe the approximate size of a finger must not be able to access or make contact with hazardous energized parts. The standard detailing the rating system used is IEC 529. Principally, this standard defines the degree of protection provided by an enclosure (barriers/guards) classified under the International Protection (IP) Code and the testing conditions required to meet these classifications.

J. Grounding and Ground Fault Circuit Interrupters (GFCI)

A key element of a safe installation is effective grounding. The term ground has many different meanings, but all are related to a connection with the earth. Ground is used to refer to a return path used for a fault to enable the proper operation of an overcurrent device.

Safety Grounding Equipment

Minimizing any voltage difference between adjacent or nearby conductive points is important. To avoid a voltage difference (shock), a low impedance path is required between the two (or more) conductive surfaces. Should a person be in contact with both surfaces when a fault occurs, no significant voltage is impressed across the person’s body, eliminating possible current flow.

Protecting Equipment Grounding Conductors (EGC)

The discussion of safety is not complete without an analysis of equipment grounding conductors (EGC). Table 250.122 of the 2002 NEC provides minimum sizing for EGCs. As noted below the table, EGCs should be sized larger, to “be capable of safely carrying the maximum fault likely to be imposed on it” [NEC 250.4(A)(5)].

For the fuse to open or the circuit breaker to operate properly, a low impedance EGC must be available for fault current to return to its source. Otherwise, any equipment experiencing a fault becomes energized at the system voltage, presenting a shock hazard for the employee. Providing protection for the equipment grounding conductor, therefore, is a safety issue. Using a current-limiting overcurrent device is the best way to reduce the energy that could be seen by the grounding conductor.

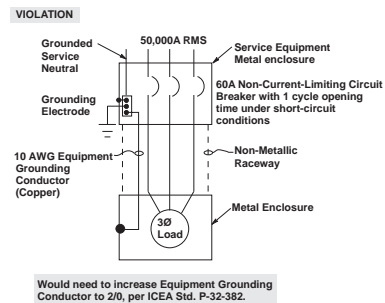

Violates NEC 110.10 and 250.4(A)(5) or 250.4(B)(4).

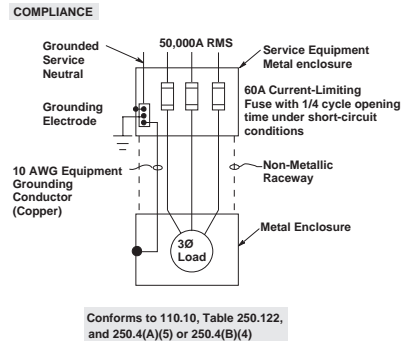

Complies with NEC and 250.4(A)(5) or 250.4(B)(4). 110.10 and 250.4(A)(5).

Must increase EGC to a 2 AWG copper to remain tight under the lug after the fault occurs.

The problem of protecting EGCs was first recognized more than 30 years ago when Eustace Soares wrote a popular grounding book *Grounding Electrical Distribution Systems for Safety*. In his book, Soares states that the “validity rating” corresponds to the amount of current and time required to cause a copper conductor to become loose under a lug after the conductor has had a chance to cool down after a fault. This validity rating is based upon raising the copper temperature to 250°C (the annealing point of copper) and then reducing the temperature back to normal running temperatures.



Good engineering practice, then, requires an investigation of the adequacy of the important ground-return path. Let-through currents for overcurrent protective devices must be compared with the short-circuit ratings of the equipment grounding conductors. Wherever let-through values exceed the minimum equipment grounding conductor withstand ratings, the equipment grounding conductor size must be increased until the withstand ratings are not exceeded.

Ground fault circuit interrupters (GFCIs)

GFCIs are designed to protect a person from electric shock when he or she simultaneously contacts a “live” (usually 120V) wire or part and a grounded object. The GFCI works by sensing a difference between the supply and return currents. When the difference exceeds 4 - 6 mA, indicating that current is flowing to ground (through the person), the device is designed to open the circuit.

GFCIs do not protect against a line-to-neutral or a line-to-line shock. Although the GFCI is an effective safety device, it is not a guarantee against shock in every situation. In addition, if GFCI-protected equipment contains transformers, a ground fault (shock) on the secondary side of the transformer might not trip the GFCI.

GFCIs normally are installed as either circuit breakers or receptacles. In either case, the GFCI might be wired to protect multiple receptacles. Individual GFCI plug-in adapters are also available.

K. Voltage testing 1,000V and less

Three basic safety issues are associated with the task of testing for voltage in instances where the maximum voltage level is 1,000V and less. The first issue involves selecting and using the right meter for the job at hand. The second issue is protecting the person from potential exposure to an energized source, and the third issue is the work process of executing the test.

On occasion, voltage-testing devices can be the source of an incident or injury, as in the following instances:

- Leads can fall out of their plugs and initiate a phase-to-phase short circuit.
- Internal components can fail, resulting in a phase-to-phase short circuit.
- Probes can slip while a reading is being observed.
- Leads can be inserted into the wrong plugs, resulting in failure.
- The device indication can be confusing, resulting in incorrect observations.
- Hands can slip off the probe.

The selected voltage-testing device must minimize all of these possibilities.

When a voltage test is performed, the person should perform the work practice as if the energy source is present (i.e., the source is energized). Even if the disconnecting means has been opened and locked-out/taggedout, until the absence of voltage has been satisfactorily verified, an electrically safe work condition does not exist. The person performing the test should be protected from any accidental release of energy until the absence of voltage has been satisfactorily verified.

Selecting a Voltage-Testing Device

Voltage testers should be selected based upon the intended use. Several types of voltage testers are manufactured for specific uses, and each device has limitations. When used to test for the absence or presence of voltage as a part of establishing an electrically safe work condition, voltage testers should have the following characteristics where direct contact can be made:

- Retractable, insulated-tip test probes
- Self-contained fault protection or limitation devices, such as internal current-limiting fuses or probe current-limiting resistors
- Voltage/current path from the probes that is not routed through the mode switch

In addition, voltage testers should conform to national consensus standards, such as UL 1244, MIL-T-28800C.

Along with the above requirements, voltage testers that are used only to test for the absence or presence of voltage should have the following characteristics:

- Single-function, voltage-only test devices or automatic mode devices that check for voltage before switching to other modes (e.g., resistance, continuity)
- Test leads that cannot be improperly connected (e.g., only two jacks are present or leads are permanently connected)

NOTE: *High-impedance voltage testers are subject to “phantom” readings from induced voltage. Verification of the absence of voltage should be required with a low-impedance voltage tester, such as a solenoid-type voltage tester. However, solenoid testers can have an adverse effect on digital control systems (DCS), programmable logic controllers (PLC), or similar equipment.*



NOTE: Solenoid-type voltage testers typically are assigned a “duty cycle” by the manufacturer. In most instances, this duty cycle is 15 seconds. The duty cycle rating must not be exceeded.

Personal Protective Equipment (PPE)

Before opening doors or removing covers for access to electrical conductors, a person should conduct a hazard analysis. The hazard analysis should be as formal and detailed as warranted by the task to be performed. Any PPE necessary to avoid injury should be in place and worn before any existing enclosure is abridged (i.e., any cover removed or any door opened). The hazard analysis must consider both shock and arc-flash.

NOTE: Many arc-flash incidents occur at the moment a door is opened or a cover removed. The person performing the test should be aware of this fact and exhibit an appropriate mind set. The mind set should consider that all electrical conductors and contact points within the enclosure are energized.

In determining appropriate PPE, the hazard analysis must consider the flash protection boundary as well as the shock approach boundaries, paying particular attention to the prohibited and restricted boundaries. Where the task involves measuring a voltage, the probes, of course, cross the prohibited boundary. Therefore, the person must be protected from unintended contact with conductive parts. Voltage-testing devices that meet the above criteria include a preventive method to minimize the possibility of a person’s hand or fingers slipping down the probes. Therefore, electrical insulation is not necessarily required. However, if hands (or other body parts) are inside the enclosure while the person is executing the task, some exposure to shock exists through unintentional contact with energized or potentially energized parts. Voltage-rated gloves should be worn. They do not hinder the task and can avoid unintentional contact with electrical conductors or contacts.

In every instance where an electrical circuit is present, a flash protection boundary exists. Depending upon the flash protection boundary, flash-protective equipment should be worn. Any body part that is within the flash protection boundary must be protected from arc-flash. If the flash protection boundary is 2 inches or less, leather gloves and ordinary safety glasses for the eyes provide sufficient protection. As the flash protection boundary extends beyond 2 inches, flame-resistant clothing and face protection should be worn. Leather gloves that are one component of voltage-rated gloves provide arc-flash protection for hands. Therefore, appropriate voltage-rated gloves should be worn. Voltage-rated gloves selected in accordance with ASTM D 120 provide protection from both shock and arc-flash, in most instances.

NOTE: Class 00 gloves have a voltage limit of 500V and are adequate in many instances for measuring voltage.

Executing the Task

The person testing for voltage should be trained to understand how the meter works and what each possible meter indication means. After the person selects the appropriate voltmeter, reacts to the hazard analysis, and understands how to interpret any meter indication, he or she should execute the following sequence of steps:

1. Open the disconnecting means.
2. Open the door or remove the cover(s)
3. Inspect the compartment interior for missing barriers, signs of arcing or burning, and any extraneous parts or components.
4. Inspect the voltmeter and probes for signs of mistreatment; verify that the probe covers move freely.
5. Insert one probe into the holder on the meter; place the meter in a stable position or ask a second person to hold the meter, if necessary, to see the indication. (Any second person must wear the same PPE as the first person.)
6. Verify that the voltmeter functions satisfactorily on a known energized voltage source.

NOTE: If the meter is auto ranging, a nearby 110V receptacle is satisfactory. If not auto ranging, the known source must be within the same voltage range.

7. Place the probe that is in the meter holder into good physical contact with a grounded point within the compartment.
8. Place the second probe into good physical contact with the opened side of the disconnecting means and before (ahead of) any fuses or any other circuit element.

NOTE: Normally, in the case of a disconnect switch, the movable side of the knife blades is available to contact with the probe. In case of a circuit breaker, the load conductor termination should be contacted.

9. Read and interpret the meter indication.
10. Repeat steps 7 and 8 for phases B and C.
11. Place the probe that is in the meter holder into good physical contact with phase A on the opened side of the disconnecting means and before (ahead of) any fuses or other circuit elements.



NOTE: Normally, in the case of a disconnect switch, the movable side of the knife blades is available to contact with the probe. In case of a circuit breaker, the load conductor termination should be contacted.

12. Place the probe in the meter holder into good physical contact with phase B in the same relative physical location.
13. Repeat steps 11 and 12, except contact phases B and C.
14. Repeat steps 11 and 12, except contact phases A and C.

NOTE: Tests for absence of voltage should be conducted at each point within the enclosure. If the compartment contains fuses, a voltage test should be conducted at both the line and load sides of each fuse, both between phases and between each phase conductor and ground. Each test should be taken at the fuse clip instead of at the fuse ferrule (endbell).

15. Measure voltage between each point within the enclosure where contact is expected.
16. Verify that the voltmeter functions satisfactorily on a known energized voltage source.

NOTE: If the meter is auto ranging, a nearby 110V receptacle is satisfactory. If the meter is not auto ranging, the known energized source must be within the same voltage range.

X. Suggestions for Limiting Arc-Flash and Shock Hazards

There are many considerations creating an electrically safe workplace for employees. Electrical safety starts with the **design** of the electrical system. The selection and layout of the system components/equipment can have considerable impact on the probability of an incident and on the severity of hazard if an incident does occur. For existing electrical systems, it may be possible to improve electrical safety conditions for workers by **upgrading** components and also by following proper equipment **maintenance procedures**. Also, there are safe **work practices** in which the workers must be trained and qualified to perform. This includes understanding the electrical hazards, the types of PPE and work procedures that are necessary.

The following start with some work practice and maintenance suggestions and then moves to electrical system design and upgrade suggestions.

A. Avoidance is the surest electrical safety measure.

If workers do not “work on or near” exposed energized components, worker safety is enhanced. Management and workers should insist on putting equipment into **an electrically safe work condition** prior to commencing electrical work. Per OSHA 1910.333(a)(1) and *NFPA 70E* 130.1, workers shall not work on or near exposed live parts except for two demonstrable reasons:

- A. De-energizing introduces additional or increased hazards (such as cutting ventilation to a hazardous location) or
- B. Infeasible due to equipment design or operational limitations (such as when performing diagnostics and testing for startup or troubleshooting and this work can only be done when circuits are energized).

B. Avoidance: implement energized electrical work permit procedures requiring signature by management.

NFPA 70E 110.8(B)(2) & 130.1(A)(1)

If live parts are not placed in an electrically safe work condition (i.e., for the reasons of increased or additional hazards or infeasibility per 130.1) work to be performed shall be considered energized electrical work and shall be performed by written permit only.

NFPA 70E 130.1(A)(3) Exemptions to Work Permit

Work performed on or near live parts by qualified persons related to tasks such as testing, troubleshooting, voltage measuring, etc., shall be permitted to be performed without an energized electrical work permit provided appropriate safe work practices and personal protective equipment in accordance with Chapter 1 are provided and used.

70E-130(A)(2) provides the elements of energized electrical work permits that include a work description, justification of why the work must be done energized, a shock hazard analysis, a flash hazard analysis, the PPE required and more. One of the most important aspects is signature approval by an authorized person, which typically should be an owner or an executive. Experience by companies that effectively use energized electrical work permits is that most work gets performed under electrically safe work conditions. That is, the energized electrical work permits rarely get approved. Usually in the process of getting the electrical work permit approved, management finds a means to do the work under electrically safe work conditions. *NFPA 70E* has an example energized work permit form in Annex J.

C. Voltage testing - requires appropriate work practices and PPE

If a worker is troubleshooting an energized electrical circuit, clearly the worker needs to use safe work practices appropriate for the circuit voltage and energy level. This includes the worker wearing the appropriate PPE for the arc-flash hazard. However, the same precautions shall be taken while checking voltage on deenergized circuits that are not yet considered to be in an electrically safe work condition. (See the Electrically Safe Work Condition Section for the required steps.) Even though a circuit may be deenergized (disconnect opened), it is:

NFPA 70E 120.3(A)

...not considered in an electrically safe work condition until all sources have been removed, the disconnecting means is under lockout/tagout, the absence of voltage is verified by an approved voltage testing device, and, where exposure to energized facilities exist, are temporarily grounded.

Essentially the same requirement is in OSHA 1910.333(b) which considers de-energized circuits as *energized* until all the appropriate steps have been completed successful.

Therefore, voltage testing of each conductor, which is a necessary step while putting the equipment in an electrically safe work condition (completing the lockout/tagout procedure), is essentially considered as working on energized parts per OSHA 1910.333(b) and considered de-energized but not in an electrically safe work condition per *NFPA 70E 120.3(A)*. *This means workers must utilize adequate personal protective equipment for the voltage level and arc-flash hazard level during the tests to verify the absence of voltage after the circuits are de-energized but not yet in an electrically safe work condition. Adequate PPE may also be required during load interruption and during visual inspection that verifies that all disconnecting devices are open.*

D. Do a flash hazard analysis for all equipment and affix NEC® 110.16 arc-flash warning label, including incident energy, flash protection boundary, and shock boundaries

NEC® 2002 - 110.16 Flash Protection

Switchboards, panelboards, industrial control panels, and motor control centers in other than dwelling occupancies, that are likely to require examination, adjustment, servicing, or maintenance while energized, shall be field marked to warn qualified persons of potential electric arc-flash hazards. The marking shall be located so as to be clearly visible to qualified persons before examination, adjustment, servicing, or maintenance of the equipment.

FPN No. 1: NFPA 70E-2000, Electrical Safety Requirements for Employee Workplaces, provides assistance in determining severity of potential exposure, planning safe work practices, and selecting personal protective equipment.

FPN No. 2: ANSI Z535.4-1998, Product Safety Signs and Labels, provides guidelines for the design of safety signs and labels for application to products.

This requirement, which is new per the NEC® 2002, is intended to reduce the occurrence of serious injury or death due to arcing faults to workers who work on or near energized electrical equipment. The warning label should remind a qualified worker who intends to open the equipment for analysis or work that a serious hazard exists and that the worker should follow appropriate work practices and wear appropriate personal protective equipment (PPE) for the specific hazard (a nonqualified worker must not open or be near open energized equipment).

NEC® 110.16 only requires that this label state the existence of an arc-flash hazard.

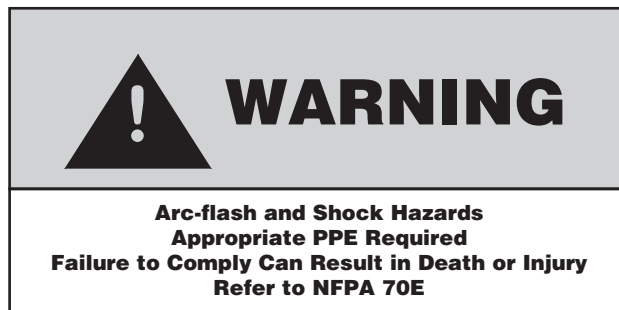

It is suggested that the party responsible for the label include more information on the specific parameters of the hazard. In this way the qualified worker and his/her management can more readily assess the risk and better insure proper work practices, PPE and tools. The example label that follows includes more of the vital information that fosters safer work practices. The specific additional information that should be added to the label includes:

- Flash Protection Boundary
- Incident energy at 18 inches expressed in cal/cm²
- PPE required



- Voltage shock hazard
- Limited shock approach boundary
- Restricted shock approach boundary
- Prohibited shock approach boundary

 <h1 style="margin: 0;">WARNING</h1>		
Arc-flash and Shock Hazards Appropriate PPE Required Failure to Comply Can Result in Death or Injury		
34 Inch 3 cal/cm ² 1	Flash Hazard Boundary Flash Hazard at 18 inches Hazard Risk Category 4cal/cm ² shirt & pants hard hat, safety glasses, FR rated faceshield	
480 VAC 42 inch 12 inch 1 inch	Shock Hazard Limited Approach Restricted Approach Prohibited Approach	500V Class 00 gloves, leather protectors
Equipment Name: XYZ Motor Starter		

Put yourself in the place of an electrician who is given the assignment to troubleshoot a circuit that is energized or to check for the absence of voltage while putting equipment in an electrically safe work condition. How does he/she know the level of arc-flash hazard for that specific equipment? The more informative label provides sufficient information for a qualified electrician to use the proper level of PPE and appropriate work practices for the level of hazard.

Note: *If the label includes the specific hazard level data, the label must be updated when there are any electrical system changes that result in different hazard levels.*

E. Worker must be qualified for the task

This is especially important for tasks that involve working on or near circuits that are not in an electrically safe work condition.

NFPA 70E 110.6(D)(1) provides the training requirements for a qualified person. This clause is extensive but some training requirements include:

- Construction and operation of equipment
- Specific work methods
- Recognition and avoidance of electrical hazards
- Special precautionary techniques
- Personal protective equipment

A person working inside the limited approach boundary of exposed live parts must in addition be trained on:

- Identifying exposed energized parts
 - Determining the voltage of exposed energized parts
 - Determining the approach boundaries

- Decision making process to determine the hazard (including shock and arc-flash), PPE, and job planning to perform task

It is important to note that a person can be qualified for some equipment and methods but not others.

Before a qualified person is asked to perform work on or near energized parts, the supervisor should be sure the person is physically and mentally ready for the task that day.

F. Do not reset a circuit breaker or replace fuses until the cause is known and rectified.

OSHA 1910.334(b)(2) & NFPA 70E 130.6(K)

Reclosing circuits after protective device operation.

After a circuit is deenergized by a circuit protective device, the circuit may not be manually reenergized until it has been determined that the equipment and circuit can be safely energized. The repetitive manual reclosing of circuit breakers or reenergizing circuits through replaced fuses is prohibited. NOTE: When it can be determined from the design of the circuit and the overcurrent devices involved that the automatic operation of a device was caused by an overload rather than a fault condition, no examination of the circuit or connected equipment is needed before the circuit is reenergized.

This is an important safety practice. If an overcurrent protective device opened under fault conditions, there is some damage at the point of the fault. If the fault is not located and rectified, reclosing on the fault again may result in an even more severe fault than the first fault. Also, if the protective device is a circuit breaker, it may have been damaged on the initial interruption. Reclosing a degraded circuit breaker on a fault may cause the circuit breaker to fail in an unsafe manner. See the next section, follow procedures for fuses and circuit breakers after interrupting a fault.

G. Follow procedures for fuses and circuit breakers after interrupting a fault

Fuses: Fuses that interrupt a circuit should be replaced with the proper fuse type and amps rating. When using modern current-limiting fuses, new factory calibrated fuses are installed in the circuit and the original level of overcurrent protection is maintained for the life of the circuit. Modern current-limiting fuses are always recommended. In most newer systems, the fuse mountings only accept modern current-limiting fuses that have a high interrupting rating. For older systems, where the fuse clips may accept older style fuses, it is recommended to only store and use modern current-limiting style fuses that also can be used in those clips. For example, if a facility has Class H fuse clips, only store and use LOW-PEAK® LPN-RK_SP and LPS-RK_SP fuses (Class RK1).

NFPA 70E 225.1

Fuses shall be maintained free of breaks or cracks in fuse cases, ferrules, and insulators. Fuse clips shall be maintained to provide adequate contact with fuses.

Fuses are typically used in conjunction with disconnects. Disconnects in most cases have no role in overcurrent protection. Disconnects should be periodically inspected and maintained. In applications where disconnects are used for interruption, such as when equipped with a ground fault protection relay or a feature that opens the disconnect when one fuse opens, the disconnect should be inspected and, if necessary, maintained after such an interruption.

Circuit Breakers: Circuit breakers need to be evaluated for suitability before being placed back into service by a person qualified for circuit breaker evaluations. This should involve visual inspection and electrical testing to specifications per manufacturer's procedures. It is advisable to electrically test a circuit breaker prior to putting it back in service. Low voltage power circuit breakers are designed so that a qualified person can examine and replace the internal parts of the circuit breaker. However, molded case circuit breakers and insulated case circuit breakers are not designed so that the internal parts can be examined and replaced in the field. Therefore, for these circuit breakers, visual inspection of the exterior and electrical testing are the only means to assess the suitability to be placed back in service.

NFPA 70E

225.2 Molded-Case Circuit Breakers. Molded-case circuit breakers shall be maintained free of cracks in cases and cracked or broken operating handles.

225.3 Circuit Breaker Testing. Circuit breakers that interrupt faults approaching their ratings shall be inspected and tested in accordance with the manufacturer's instructions.

After a circuit breaker interrupts a fault, it may not be suitable for further service. UL 489, the product standard for molded case circuit breakers, only requires a circuit breaker to interrupt two short-circuit currents at its interrupting rating. Circuit breakers that are rated 100A or less do not have to operate after only one short-circuit operation under "bus bar" short-circuit conditions. It is possible for a fault to erode the circuit breaker's contacts, erode the arc chutes, or weaken the circuit breaker's case. If the fault current is high, circuit breaker manufacturers recommend that a circuit breaker should receive a thorough inspection with replacement, if necessary. Some difficulties in the evaluation process are not knowing a circuit breaker's service history, what level of fault current a circuit breaker interrupted, or what degradation occurred on

the inside of the circuit breaker. That is why proper testing is recommended.

Another insightful quote is by Vince A. Baclawski, Technical Director, Power Distribution Products, NEMA; published in *EC&M Magazine*, pp. 10, January 1995:

After a high level fault has occurred in equipment that is properly rated and installed, it is not always clear to investigating electricians what damage has occurred inside encased equipment. The circuit breaker may well appear virtually clean while its internal condition is unknown. For such situations, the NEMA AB4 "Guidelines for Inspection and Preventive Maintenance of MCCBs Used in Commercial and Industrial Applications" may be of help. Circuit breakers unsuitable for continued service may be identified by simple inspection under these guidelines. Testing outlined in the document is another and more definite step that will help to identify circuit breakers that are not suitable for continued service.

After the occurrence of a short circuit, it is important that the cause be investigated and repaired and that the condition of the installed equipment be investigated. A circuit breaker may require replacement just as any other switching device, wiring or electrical equipment in the circuit that has been exposed to a short circuit. Questionable circuit breakers must be replaced for continued, dependable circuit protection.

H. Testing fuses

When a person suspects that a fuse has opened, he or she should remove both indicating and non-indicating fuses from the circuit and check them for continuity.

To minimize exposure to electrical hazards, troubleshooting should be performed on de-energized equipment, where possible. Resistance measurements are as reliable as voltage measurements.

I. Properly test knife-blade fuses

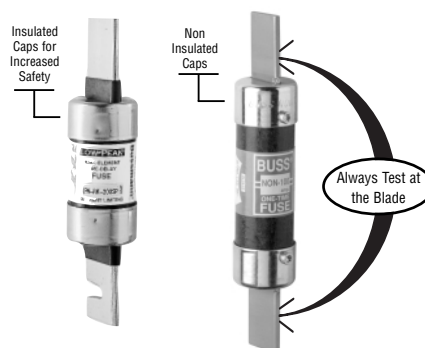

A continuity test across any knife-blade fuse should be taken only along the fuse blades. Do not test a knife-blade fuse with meter probes to the fuse caps.



A common mistake when electricians are testing *knife-blade* fuses (have blades on ends as shown in illustration) is to touch the end caps of the fuse with their probes. Contrary to popular belief, fuse manufacturers do not generally design their *knife-blade* fuses to have electrically energized fuse caps during normal fuse operation. Electrical inclusion of the caps into the circuit occurs as a result of the coincidental mechanical contact between the fuse cap and terminal extending through it. In most brands of *knife-blade* fuses, this mechanical contact is not guaranteed; therefore, electrical contact is not guaranteed. Thus, a resistance reading taken across the fuse caps is not indicative of whether or not the fuse is open.

In a continuing effort to promote safer work environments, Bussmann® has introduced newly designed versions of *knife-blade* FUSETRON® Fuses (Class RK5) and *knife-blade* LOW-PEAK® Fuses (Class RK1) for some of the amps ratings. The improvement is that the end caps are insulated to reduce the possibility of accidental contact with a live part. With these improved fuses, the informed electrician knows that the end caps are isolated. With older style non-insulated end caps, the electrician doesn't really know if the fuse is "hot" or not by simply taking readings at the end caps. A portion of all testing-related injuries could be avoided by proper testing procedures. Bussmann® hopes to reduce such injuries by informing electricians of proper procedures.

J. Good housekeeping upon completion of electrical work

When electrical workers have completed work on equipment, it is important that prior to reenergization, all tools, scrap wire, and other debris be removed. This may avoid an incident when the doors are opened in the future. There are incidents where a worker opens an enclosure door on equipment and a tool, skinned conductor, or knockout becomes dislodged and falls across exposed energized parts creating an arcing fault.

K. Under normal operation, keep electrical equipment doors closed

When equipment is thermally affected by the ambient temperature or electrical loading, the remedy is not leaving the electrical equipment doors open. This is a serious safety hazard for personnel and property.

L. Move people outside the flash protection boundary

Numerous injuries and deaths occur when workers rack circuit breakers or switch medium voltage switches and circuit breakers. Systems should be designed with a remote open/close operating fea-

ture for medium voltage switches and circuit breakers. Let the worker remotely control a motorized unit so he/she does not have to be directly in harms way. Also, provide extended length racking tools as in the illustration.

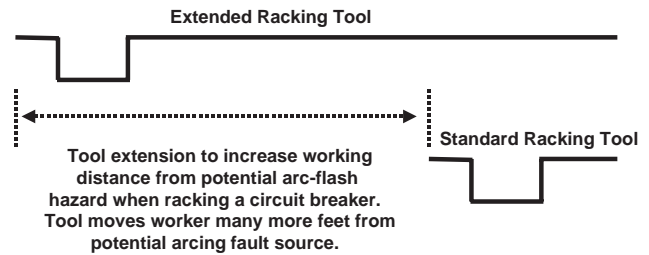

M. Overcurrent protection reliability, maintenance requirements, and the effect maintenance has on arc-flash hazard

NFPA 70E 210.5 Protective Devices

Protective devices shall be maintained to adequately withstand and interrupt available fault current.

The reliability of overcurrent protective devices can directly impact arc-flash hazards. The opening time of overcurrent protective devices is critical in the resultant arc-flash energy released when an arcing fault occurs. The longer an overcurrent protective device takes to clear a given arcing fault current, the greater the arc-flash hazard. When an arcing fault occurs, or for that matter, when any fault current occurs, the overcurrent protective device must be able to operate as intended. Therefore, the reliability of overcurrent protective devices is critical — they need to open as originally specified, otherwise the flash hazard can escalate to higher levels than expected.

Two different types of overcurrent protection technologies provide different choices in reliability and maintenance requirements. This choice can impact the flash hazard. Either:

- (1) Use overcurrent protective devices that are reliable and do not require maintenance, or
- (2) If the overcurrent protective devices require periodic maintenance, then maintenance must be performed as required per the manufacturer's instructions and industry standards.

Current-limiting fuses

Modern fuses are reliable and retain their ability to open as originally designed under overcurrent conditions. When a fuse is replaced, a new factory calibrated fuse is put into service — the circuit has reliable protection with performance equal to the original specification. Modern current-limiting fuses do not require



maintenance other than visual examination and insuring that there is no damage from external thermal conditions or liquids. Under overcurrent conditions, fuse short-circuit element operation is reliable.

Circuit breakers

Circuit breakers are mechanical overcurrent protective devices, which require periodic exercise, maintenance, testing, and possible replacement. A circuit breaker's reliability and operating speed are dependent upon its original specification and its condition. A specific circuit breaker's condition is dependent on many variables, some of which are not typically recorded and saved; length of service, number of manual operations under load, number of operations due to overloads, number of fault interruptions, humidity, condensation, corrosive substances in the air, vibrations, invasion by foreign materials or liquids, damage due to thermal conditions such as loose connections, erosion of contacts, and erosion of arc chutes. To help keep a circuit breaker within original specification, a circuit breaker manufacturer's instructions for maintenance must be followed.

Failure to do periodic maintenance on a circuit breaker or maintenance after interrupting a fault may result in longer interruption times or the inability to interrupt overcurrents; this can drastically affect the potential arc-flash energy that can be released.

Protective Devices Maintenance as It Applies to the Arc-Flash Hazard, is a technical paper by Dennis Neitzel, AVO Training Institute that is available on www.bussmann.com under Electrical Safety. This paper is a good resource on this topic. Excerpts from this paper:

Where proper maintenance and testing (on circuit breakers) are not performed, extended clearing times could occur creating an unintentional time delay that will effect the results of flash hazard analysis...

Fuses, although they are protective devices, do not have operating mechanisms that would require periodic maintenance; therefore, this article will not address them. ...

Circuit breakers installed in a system are often forgotten. Even though the breakers have been sitting in place supplying power to a circuit for years, there are several things that can go wrong. The circuit breaker can fail to open due to a burned out trip coil or because the mechanism is frozen due to dirt, dried lubricant, or corrosion. The overcurrent device can fail due to inactivity or a burned out electronic component. Many problems can occur when proper maintenance is not performed and the breaker fails to open under fault conditions. This combination of events can result in fires, damage to equipment or injuries to personnel.

N. Designing systems: overcurrent protective device selection

Use the most current-limiting overcurrent protective devices possible. There are a variety of choices in the market for overcurrent protective devices. A fuse or circuit breaker that is not marked "current-limiting" has not been tested and listed as a current-limiting overcurrent protective device. For those that are marked "current-limiting," there are different degrees of current-limitation to consider — some are considerably more current-limiting than others.

One of the most important decisions for impacting the flash hazard can be the type, amps rating, and current-limiting ability of the overcurrent protective devices. It has been demonstrated that the magnitude of fault current and the length of time the current flows is directly related to the energy released by an arcing fault. Overcurrent protective devices that limit the magnitude of the fault current that flows and reduce the time duration of the fault current, can reduce the energy that is released by an arcing fault. In the discussion that follows, the types of devices are divided between (1) non current-limiting and (2) current-limiting. The typical six general choices are shown in the figure below and are discussed in the paragraph after the figure.

Figure X(N)(1)

Choice of Overcurrent Protective Devices Can Make A Difference

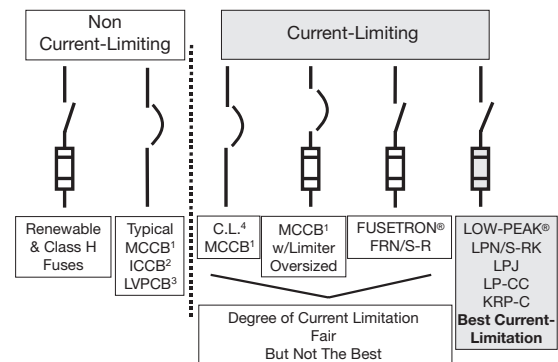

- 1 MCCB - Molded Case Circuit Breaker
- 2 ICCB - Insulated Case Circuit Breaker
- 3 LVPCB - LV Power Circuit Breaker
- 4 C.L. - Current-Limiting

1. Non current-limiting overcurrent protective devices

Renewable & Class H fuses are outdated type fuses that are not considered current-limiting that also have a low interrupting rating. These fuses are not recommended to assist in reducing arc-flash hazards because they let-through too much fault current for too long a time, and their interrupting rating is too low.



Non Current-limiting Circuit Breakers: The typical **molded case circuit breaker, insulated case circuit breaker** and **low voltage power circuit breaker** are not listed as current-limiting and are much like the renewable and Class H fuses. Therefore these devices do not significantly reduce the level of fault currents and they take longer to open. These devices can permit large amounts of energy to be released during an arcing fault. For instance, even if the fault current is in the instantaneous setting range of a circuit breaker, the higher the fault current the more the energy that is released. Circuit breakers require periodic maintenance and/or replacement to better insure they will operate as intended. If not maintained properly, circuit breaker clearing times can extend beyond their specifications and the arc-fault energy can be significantly greater than expected.

2. Current-limiting overcurrent protective devices

The four types of devices depicted on the right in Figure X(N)(1) are all current limiting. Current limiting devices provide the benefit of reducing the arc-fault energy released for higher fault currents by reducing both the current magnitude and time duration (when the fault current is within their current-limiting range). However, there are different degrees of current-limitation. And different devices become current-limiting at different levels of fault current. If the fault current is in the current-limiting range of current-limiting fuses, the energy released during an arc-fault typically does not increase as the fault current increases. This is a very important criterion.

Current-limiting molded case circuit breakers are a better choice than standard molded case circuit breakers. The cost is three to four times as much as standard molded case circuit breakers. The degree of current-limitation is typically fair, but can vary significantly. UL 489, the Molded Case Circuit Breaker Standard, does not establish different short-circuit let-through I_p and I^2t values for various amps rated circuit breakers like UL 248, the Fuse Standards. Periodic maintenance and testing is necessary for all circuit breakers to help ensure that they will operate as intended. If not maintained properly, their clearing times can extend beyond their specifications and the arc-fault energy can be significantly greater than expected.

Standard circuit breakers that incorporate fuses as limiters are another current-limiting alternative. The cost is higher than that of standard circuit breakers. The limiter is intended only to provide current-limiting short circuit protection. However, the fuse limiters are oversized; so

that the circuit breaker operates for lower level short-circuit currents. Therefore, these fuse limiters provide far less protection than current-limiting fuses sized to the load such as when the circuit is a fusible switch system.

The result with the circuit breaker/limiter alternative is typically higher arcing fault energy releases. For instance, the circuit breaker limiter may be sized at two to ten times the equivalent current-limiting fuses that would be used instead of a circuit breaker. As an example, a 600A circuit breaker with fuse limiters may have limiters that are equivalent to 1600A or greater fuses. 600A LOW-PEAK® Fuses would typically provide much lower arc-flash incident energy than a limiter that is equivalent to a 1600A fuse. Properly sized LOW-PEAK® Fuses enter the current-limiting range sooner and let-through less fault energy than a 1600A limiter.

FUSETRON® dual-element, time delay fuses FRS-R and FRN-R (Class RK5) provide current-limiting protection. The level of current limiting ability is good. A better choice for applications using Class R fuse clips is the LOW-PEAK® LPS-RK_SP & LPN-RK_SP (Class RK1) because these fuses are more current-limiting and enter their current-limiting range at lower fault levels.

LOW-PEAK® fuses, LPJ_SP (Class J), **LPS-RK_SP & LPN-RK_SP** (Class RK1), **LP-CC** (Class CC) and **KRP-C_SP** (Class L) and **TRON JJN/JJS fuses** (Class T), offer the best practical current-limiting protection. They have a significantly better degree of current limitation than the other alternatives discussed. In addition, they typically enter their current-limiting range at lower currents than the other fuses or limiter alternatives. The LOW-PEAK® family of fuses is the most current-limiting type fuse family for general protection and motor circuit protection.

The table below illustrates the potential benefits of using fuses that have greater current-limiting ability. In evaluating arc-flash protection, the overcurrent protective device's I^2t let-through is a direct indicator of the arc-flash energy that would be released. This table compares the UL 248 Fuse Standards and UL 489 Molded Case Circuit Breaker Standard maximum permitted I^2t let-through limits. These values shown are the maximum limits. Commercially available products will have values less than shown.

UL Standard Maximum I^2t (amp²seconds) Let-Through Limits for 50,000A Short-Circuit Test

Device Amps Rating	Fuse Class J 600V	Fuse Class RK1 600V	Fuse Class RK5 600V	Current Limiting Molded Case Circuit Breaker	Molded Case Circuit Breaker
600A	2,500,000	3,000,000	10,000,000	20,750,000	No Limit
400A	1,000,000	1,200,000	5,200,000	20,750,000	No Limit
200A	200,000	400,000	1,600,000	20,750,000	No Limit

Note: I^2t is proportional to thermal energy. I^2t is a measurable value that is used to evaluate fault protection performance of overcurrent protective devices. The lower the I^2t that an overcurrent protective device lets-through, the lower the thermal energy released.



The UL 248 Fuse Standards set short-circuit I^2t let-through limits for current-limiting fuse types such as Classes J, RK1, and RK5. Different limits are set for each fuse major amps rating case size such as 30, 60, 100, 200, 400, and 600A. Fuses that are tested and listed as current-limiting are marked "current-limiting".

UL 489 Standard for Molded Case Circuit Breakers does not have I^2t let-through limits for circuit breakers that are not tested and listed as current limiting; these circuit breakers will not have a marking stating "current-limiting". Circuit breakers that are marked "current-limiting" have I^2t let-through limits, which is the lower of either what the manufacturer claims or the symmetrical short-circuit calibration wave for a $\frac{1}{2}$ cycle without the circuit breaker in the circuit. UL 489 does not require current-limiting circuit breaker I^2t let-through limits to apply when the circuit breakers are tested under "bus bar" test conditions. UL 489 does not require different I^2t let-through limits for different circuit breaker amps ratings or frame sizes.

Figure X(N)(2)
Illustrates Different Levels of Protection
UL I_p Limits For 400A Rating

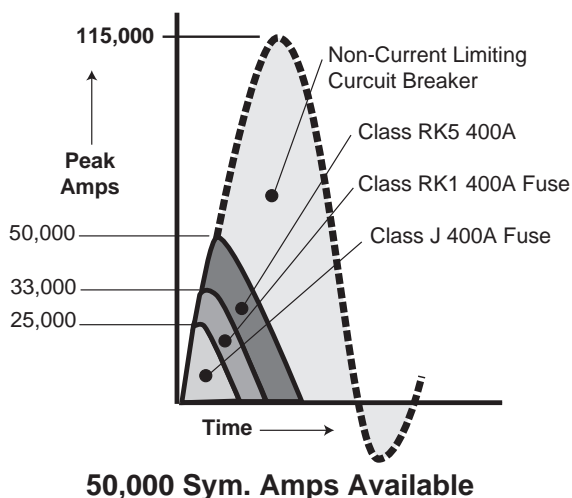
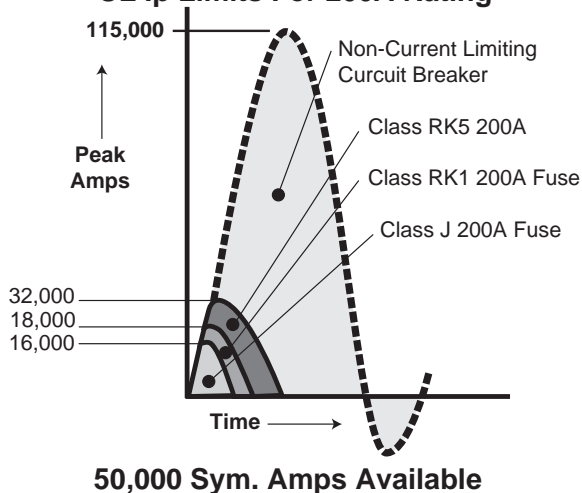

Figure X(N)(3)
Illustrates Different Levels of Protection
UL I_p Limits For 200A Rating



Figures X(N)(2) and X(N)(3) illustrate another way to gain an understanding of the importance of using overcurrent protective devices that have better current-limiting ability. The dotted line represents the asymmetrical fault current that could flow with 50,000 symmetrical amps available — the peak current could reach 115,000A. Figure X(N)(2) shows the UL I_p limit for a 400A Class RK5 fuse is 50,000A, for a 400A RK1 fuse the I_p limit is 33,000A and for a 400 Class J fuse it is 25,000A. The limits for 200A UL fuses are less and illustrated in Figure X(N)(3).

Recommendation: Design new systems with LOW-PEAK® Fuses and TRON Fuses. LPJ_SP Fuses are Class J which provide an advantage in that Class J fuses are physically size rejecting. No other class fuse can be inserted in a Class J mounting. LPS-RK_SP and LPN-RK_SP Fuses are Class RK1 and should be installed in Class R clips that only accept Class R fuses. Class RK5 fuses can also be inserted in Class R clips. KRP-C_SP Fuses are Class L which are physically size rejecting. TRON JJN or JJS Fuses are Class T and are also physically size rejecting.

O. For circuits above 600A, specify switches with shunt-trip that will open the switch when a fuse opens

There are options for some fused switches that open the switch when one of the fuses opens. This option can be included on new switches or can be retrofitted on some existing switches. Tests have shown on larger amps rated circuits that this option may reduce the arc-flash hazard level. This is an electro-mechanical option, which may require maintenance after an operation.

P. Improving existing fusible systems that have class H, R, J, CC, or L fuse clips, upgrade to LOW-PEAK® fuses

If the electrical system is an existing fusible system, consider replacing the existing fuses with the LOW-PEAK® family of fuses. If the existing fuses in the clips are not the most current-limiting type fuses, upgrading to the LOW-PEAK® family of fuses can reduce the hazards associated with arc-flash. To assist the process visit www.bussmann.com for the LOW-PEAK® upgrade service. Submit the electronic listing of 600V and less fuse part numbers for all manufacturers at your facility and receive a listing of the LOW-PEAK® fuse part numbers for the upgrade.

Owners of existing fusible systems should consider upgrading to LOW-PEAK® fuses, Classes RK1, L, J and CC. An assessment of many facilities will uncover that the installed fuse types are not as current-limiting as desired or that fuses were installed decades ago and new, better current-limiting fuses are now available.



LOW-PEAK® Fuses LPS_RK_SP/LPN-RK_SP (Class RK1), LPJ_SP (Class J), LP-CC (Class CC) and KRP-C_SP (Class L) offer the best practical current-limiting protection. The LOW-PEAK® family of fuses are the most current-limiting type fuse family for general protection and motor circuit protection.

Upgrade to LOW-PEAK® Fuses

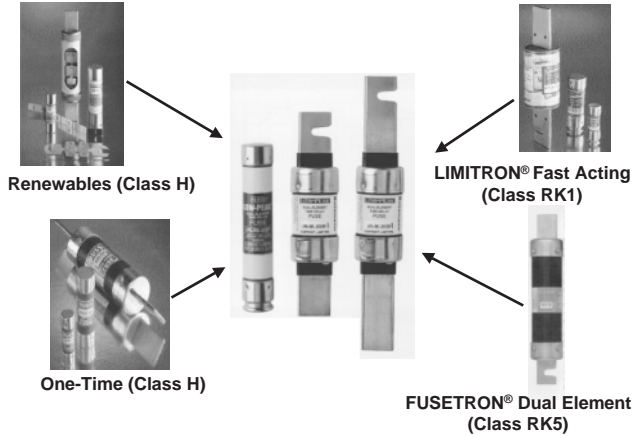

LOW-PEAK® Upgrade Example For 600V Classes H & R Fuse Clips

A6D	KTS-R	
A6K-R	LES	
A6K-R	LES-R	
A6X type 1	LES-RK	
ATS-DE	LKS	
CHR	LLS-RK	
CTS-R	LOS-RK	
DES	NLS	
DES-R	NOS	
DLS	NRS	
DLS-R	OTS	
ECS-R	RES	
ERS	RFS	
FLS	RHS	
FLS-R	RLS	
FRS	SCLR	
FRS-R	TRS	
FTS-R	TRS-R	
GDS	656	
HA	10KOTS	
KLS-R	50KOTS	
KOS		

This is an upgrade example for 600V rated Class H and Class R fuse clips. All of these part numbers in the two left columns that are 600V rated Class H and Class R fuses from Bussmann® and other manufacturers can be replaced with the LOW-PEAK® LPS-RK (amp)SP fuses. There are several benefits in upgrading in this manner. One benefit is better arc-flash protection.

Q. Specify Type 2 (“no damage”) protection for motor controllers

Motor starters are very susceptible to damage due to short-circuit currents. If a worker needs to work within a motor starter enclosure while energized, it can be a serious safety hazard. Specifying Type 2 motor starter protection can reduce the risk.

The engineer or person with the responsibility to specify or choose the type of equipment can choose the level of motor starter protection desired: Type 1 or Type 2.

A choice of motor starter protection is available: both UL 508E (outline of investigation) and IEC 60947-4-1 differentiate between two types of protection for motor circuits. The overcurrent protective device makes the difference.

Type 1 – “Requires that, under short-circuit conditions, the contactor or starter shall cause no danger to persons (with enclosure door closed) or installation and might not be suitable for further service without repair and replacement of parts.” Damage is allowed, requiring partial or complete component replacement. It is possible for the overload devices to vaporize and the contacts to weld. Short-circuit protective devices interrupt the fault current, but are not required to provide component protection. The requirements for Type 1 protection are similar to the requirements for listing to UL 508. See photos below. If a worker has any unprotected body parts near such an event, he/she may be injured.



Photos of Type 1 Protection: Test photos of before, during and after of: MCP intended to provide motor branch circuit protection for 10HP, IEC Starter with 22,000A available at 480V. The heater elements vaporized and the contacts were severely welded. This could be a hazard if the door is open and a worker is near.

Type 2 – “Requires that, under short-circuit conditions, the contactor or starter shall cause no danger to persons (with enclosure door closed) or installation and shall be suitable for further use.” No damage is allowed to either the contactor or overload relay. Light contact welding is permitted, but contacts must be easily separable. “No damage” protection for NEMA and IEC motor starters can only be provided by a current-limiting device. See photos below.

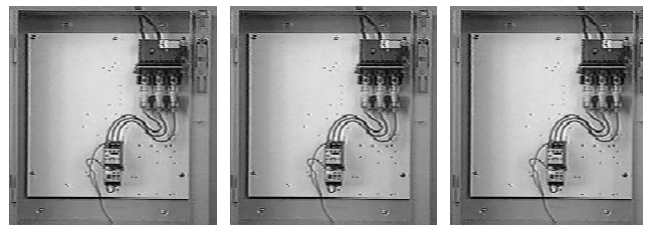

Photos of Type 2 Protection: Test photos of before, during and after of same test circuit and same type starter during short-circuit interruption as in Photo 1, 2 and 3. The difference is LOW-PEAK® LPJ_SP current-limiting fuses provide the motor branch circuit protection. This level of protection reduces the risk for workers.



The fuses that typically meet the requirements for Type 2 “no damage” protection that are the result of the controller manufacturers testing are LOW-PEAK® LPJ_SP fuses (Class J), LP-CC fuses (Class CC) and LPS-RK_SP/LPN-RK_SP fuses (Class RK1). As discussed in the two previous section, these are very current-limiting fuses which can protect the sensitive controller components.

For more discussion on this subject and some Type 2 Tables by motor starter manufacturers, see Cooper Bussmann’s publication SPD, section *Type 2 “No Damage” Motor Starter Protection* which can be found on www.bussmann.com.

R. Finger-safe products and terminal covers

Although most electrical workers and others are aware of the hazard due to electrical shock, it still is a prevalent cause of injury and death. One of the best ways to help minimize the electrical shock hazard is to utilize finger-safe products and non-conductive covers or barriers. Finger-safe products and covers reduce the chance that a shock or arcing fault can occur. If all the electrical components are finger-safe or covered, a worker has a much lower chance of coming in contact with a live conductor (shock hazard). Also, the risk that a conductive part falling across bare, live conductive parts and creating an arcing fault is greatly reduced (arc-flash hazard).

Shown below are several items to help minimize shock hazard and minimize the initiation of an arcing fault: the new Bussmann® CUBEFuse™ (1 to 100A) that are IP20 finger-safe and very current-limiting protective devices. SAMI™ fuse covers for covering fuses, Safety J fuse holders for LPJ fuses, CH fuse holders available for a variety of Bussmann® fuses and Bussmann® disconnect switches, with fuse and terminal shrouds. All these devices can reduce the chance that a worker, tool or other conductive item will come in contact with a live part.



S. Isolate the circuit: install in-sight fusible disconnect for each motor

Electrical systems must be designed to support preventive maintenance, with easy access to the equipment. Designers must isolate equipment for repair with a disconnecting means that provides for adequate implementation of lockout/tagout procedures. A sound design provides disconnecting means at all motor loads in addition to the disconnecting means required at the controller that can be locked in the open position. Disconnecting means at the motor provide improved isolation and safety for maintenance and for use in case of an emergency.

Install HP-rated fusible disconnects (with permanently installed lockout provision) within sight and within 50 feet of every motor or driven machine. This measure fosters safer work practices and can be used for an emergency disconnect if there is an incident. An in sight motor disconnect is more likely to be used by a worker for the lockout procedure to put equipment in an electrically safe work condition prior to doing work on the equipment.

The 1999 NEC® required a disconnect in sight of a motor or machine. However, there was an exception that if the disconnect at the controller could be locked out, then the in-sight disconnect could be omitted. 430.102 changed in the 2002 NEC®, resulting in a tighter requirement that provides for better worker safety. An in-sight motor disconnect is required even if the disconnect ahead of the controller can be locked out. There are exceptions for some specific industrial applications.

In-Sight Motor Disconnect

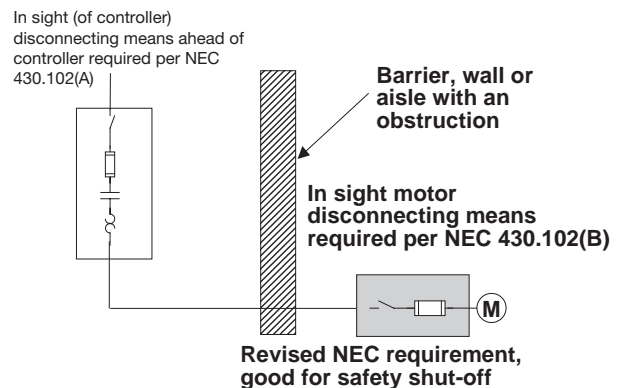

T. Isolate the circuit-selective coordination

Today, more than ever, one of the most important parts of any installation is the electrical distribution system. Nothing can stop all activity, paralyze production, inconvenience and disconcert people, and possibly cause a panic more effectively than a major power failure.

Isolation of a faulted circuit from the remainder of the installation is **mandatory** in today's modern electrical systems. Power blackouts cannot be tolerated.

Isolating the faulted circuit can also be a serious safety issue. According to the *NEC*[®], Article 240.12, where an orderly shutdown is required to minimize hazards to personnel and equipment, a system of coordinated short-circuit protection shall be permitted.

Therefore, selecting protective devices based solely on their ability to carry the system load current and interrupt the maximum fault current at their respective levels is not enough. A properly engineered system allows **only** the protective device nearest the fault to open, leaving the remainder of the system undisturbed and preserving continuity of service.

Selective coordination is considered the act of isolating a faulted circuit from the remainder of the electrical system, thereby eliminating unnecessary power outages. The faulted circuit is isolated by the selective operation of only that overcurrent protective device closest to the overcurrent condition. For more information pick Selective Coordination under Application Info at www.bussmann.com.

U. High impedance-grounded wye systems

Some users are designing their 480V electrical systems with high impedance grounded wye systems. This type of system can reduce the probability that arcing faults will occur. With high-impedance-grounded wye systems, if a worker's screwdriver slips, simultaneously touching an energized bare phase termination and the enclosure, a high energy arc-fault would not be initiated. However, this type of system does not totally eliminate the hazard. If the worker's screwdriver simultaneously touches the energized bare terminations of two phases, an arcing fault may occur. If high impedance grounded wye systems are being designed or an existing solidly grounded wye system is being retrofitted to this type system, it is imperative to consider the single-pole interrupting capabilities of any circuit breakers and self-protected starters that may be considered or already installed. In addition, any slash voltage-rated circuit breakers or other

mechanical devices may not be suitable. For an in-depth discussion on this subject, see Bussmann's publication SPD, sections *Single-Pole Interrupting Capability* and *Slash Voltage Rating* which can be found on www.bussmann.com.

V. Do not use short-time delay settings on circuit breakers

Some circuit breakers are equipped with a short-time delay mechanism, which is intended to delay operation of the circuit breaker with an intentional delay under fault conditions. Short time delay breakers are used on feeders and mains so that downstream molded case breakers may clear a fault without tripping the larger upstream circuit breaker. In many cases a circuit breaker with a short-time delay setting will not have an instantaneous setting. So a fault is permitted to flow for an extended time. Under fault conditions, a short-time delay sensor intentionally delays signaling the circuit breaker to open for the time duration setting of the short-time delay. For instance, a low voltage power circuit breaker with a short-time delay and without instantaneous trip permits a fault to flow for the length of time of the short-time delay setting, which might be 6, 12, 18, 24, or 30 cycles.

There is an adverse consequence associated with using circuit breakers with short-time delay settings. If an arcing fault occurs on the circuit protected by a short-time delay setting, a tremendous amount of damaging fault energy can be released while the system waits for the circuit breaker short-time delay to time out. The longer an overcurrent protective device takes to open, the greater the flash hazard due to arcing faults. Research has shown that the arc-flash hazard increases with the time duration the current is permitted to flow.

System designers and users should understand that using circuit breakers with short-time delay settings can greatly increase the arc-flash energy. If an incident occurs when a worker is at or near the arc-flash, the worker may be subjected to considerably more arc-flash energy than if an instantaneous trip circuit breaker or, better yet, a current-limiting circuit breaker or current-limiting fuses were protecting the circuit.

Note: *Designers typically use short-time delays to achieve fault coordination with downstream circuit breakers. If selective coordination and fast fault opening time are design objectives, there are other, better alternatives. For instance, systems designed with current-limiting fuses can usually achieve both objectives.*



Z. If using circuit breakers, specify zone-selective interlocking

If using circuit breakers, in order to achieve coordination, circuit breakers with short-time delay are typically specified. However, short-time delay settings can permit extremely hazardous incident energy levels. Another option with circuit breakers is to use zone-selective interlocking. In this scheme, the circuit breakers with this option have communication wiring between the circuit breakers and the circuit breakers' sensing elements communicate. For instance, the main and feeder circuit breakers might be equipped with zone-selective interlocking. For faults on the load side of the feeder circuit breaker, the main circuit breaker, if signaled by the feeder circuit breaker, might be set to have a short-time delay of 24 cycles. This allows for the main circuit breaker to wait for the feeder to open for faults on the feeder circuit. However, if the fault is on the main circuit, then the main circuit breaker will not receive a signal from a feeder circuit breaker and the main circuit breaker will open without an intentional delay.

AA. "Smart" equipment

By using digital technologies, remotely perform voltage testing and check current readings and other parameters. Utilizing this design method shifts some troubleshooting from "working on or near" exposed energized components to the remote computer screen with the equipment doors closed and latched. These schemes can reduce the associated electrical hazards and reduce the required PPE.

BB. Utilize arc resistant (arc diverting) medium voltage switchgear

Some medium voltage switchgear is designed to better withstand internal arcing faults than standard equipment. This equipment is typically designed with stronger door hinges and latches, better door gaskets and hinged enclosure top panels. The concept is to divert the resultant explosive hot gases and pressures from an internal arcing fault via the hinged enclosure top panels. If the switchgear is installed indoors then ductwork or a similar means of exhausting the hot gases to the outside of the building is required.

Note: This equipment is rated to withstand specific levels of internal arc-faults with all the doors closed and latched. The rating does not apply with any door opened. So it is not applicable when a worker is working on the equipment with an open door or panel. Also, the term "arc resistant" is a bit misleading. The internal switchgear must withstand an internal arcing fault and, therefore, the sheet metal, etc., must resist or withstand a specified arc-fault. However, a major feature of this equipment is diverting the arc-fault

byproducts (hot ionized gases and blast) via the hinged enclosure top panels. This feature helps to prevent the arc-fault from blowing open the doors or side panels and venting the arc-fault byproducts where a worker may be standing.

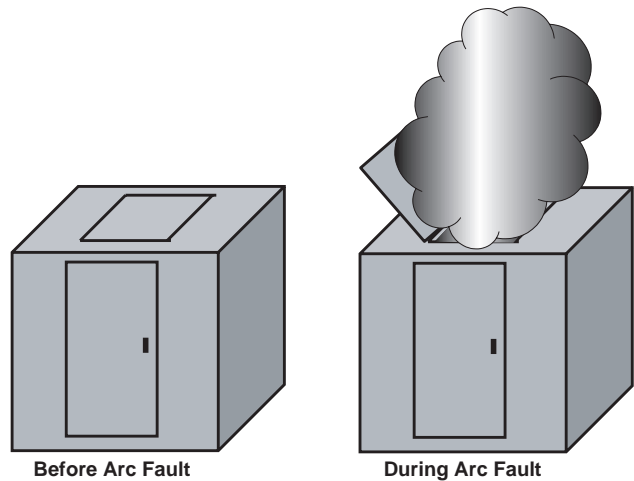

CC. Retrofit existing non-current-limiting feeders that have high fault potential with LOW-PEAK® fuses by cutting in fusible switches

There is a large legacy of installed circuit breakers that may be slow in operating, have not been maintained properly or may not even operate on overcurrents. It may be expensive to remove the existing gear and install new fusible or circuit breaker gear. A solution might be to use the circuit breaker as a disconnect and retrofit LOW-PEAK® fuses properly sized for the load.

Retrofit Potential: Feeders to MCCs, Busways, and Panels

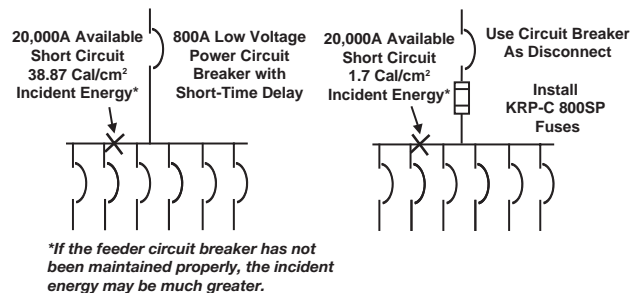

DD. Retrofit under-utilized circuits with lower-amps rated LOW-PEAK® fuses

Sometimes circuits are under-utilized. In this case, it is recommended to meter for the actual current under the maximum load condition, then install LOW-PEAK® fuses sized for this load (see typical fuse sizing calculation method on page 176 of the SPD publication). For instance, if an 800A feeder to a motor control center draws only 320A, install 400A LOW-PEAK® fuses.

Size Fuses for Actual Loads

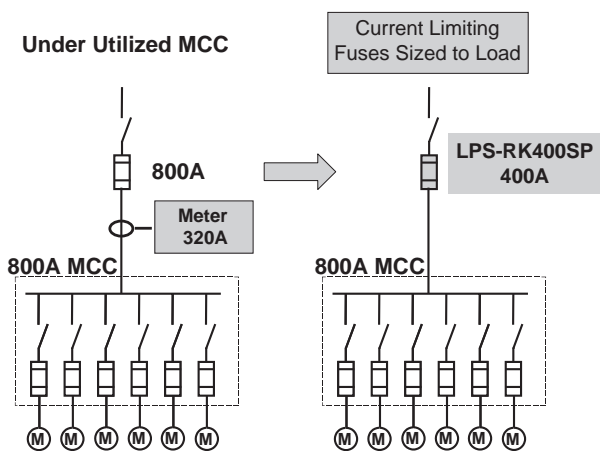

EE. Proper interrupting rating

Interrupting rating is the maximum current that a fuse or circuit breaker can safely interrupt under standard test conditions. “Safely interrupts” pertains to the condition of the fuse or circuit breaker during and after the interruption.

Many people in the electrical industry still do not understand what interrupting rating means, they do not appreciate the consequences of improper interrupting rating, or they have yet to figure out or care that available short-circuit currents in electrical systems can increase beyond a device’s interrupting rating over time due to system changes. An overcurrent protective device that attempts to interrupt a fault current beyond its interrupting rating can violently rupture. An overcurrent protective device applied with inadequate interrupting rating is a serious safety hazard. This in itself can be an arc-flash and arc-blast hazard, plus the violent rupturing can cause an arcing fault in other parts of the equipment.

Be absolutely sure to use overcurrent protective devices that have adequate interrupting ratings at their point of application for the maximum available short-circuit current. Consideration for interrupting rating should be for the life of the system. All too often, transformers are replaced or systems are upgraded and the available short-circuit currents increase.

Modern current-limiting fuses have interrupting ratings of 200,000 and 300,000A, which virtually eliminates this hazard contributor. However, renewable and Class H fuses only have a 10,000A interrupting rating.

Circuit breakers have varying interrupting ratings, so they need to be assessed accordingly. If systems changes occur, it is important to reassess whether the installed circuit breakers still have sufficient interrupting ratings. Plus, circuit breakers must be periodically maintained and, possibly, tested to verify their ability to interrupt as intended.

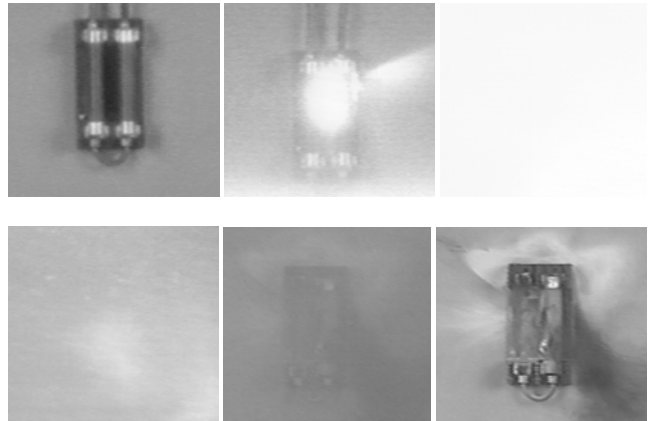

The photos above show what happens when Class H fuses, which have an interrupting rating of only 10,000A, are subjected to a 50,000A fault. Obviously, this is a misapplication, but this emphasizes how important proper interrupting rating is for arc-flash protection and proper application of overcurrent protective devices. In a fraction of a second the fuses can violently rupture. This could be a very serious safety hazard for a worker. This is a violation of NEC 110.9.

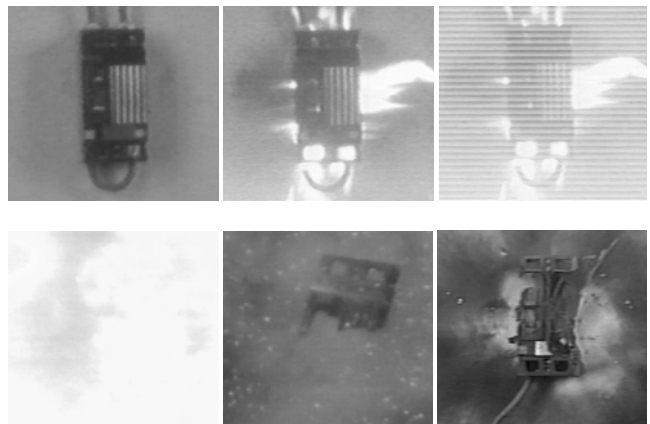

The photos above show what happens when a circuit breaker with an interrupting rating of 14,000A is subjected to the same 50,000A fault. This also is a misapplication, but illustrates the sudden violence that occurs. In a fraction of a second, the circuit breaker violently ruptured, which could be a very serious safety hazard for a worker. This violates NEC 110.9.

The photos below show a proper application that meets NEC 110.9. Note there is no violence or emitted byproducts. In this case, LOW-PEAK® LPJ fuses safely interrupt this the 50,000A available short-circuit current. The LPJ fuses have an interrupting rating of 300,000A.

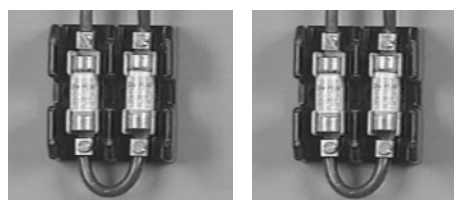

Before test. During and after test.



XI. Costs Associated with Safety

What are the costs associated with accidents, incidents, injuries, and implementing a good safety program?

In most cases, employer safety efforts are intended for two purposes:

- As an inherent benefit to employees
- To build a legal defense, just in case an injury occurs

Gathering and compiling information related to costs of incidents and injuries is very difficult. Employers and owners tend to avoid public access to that type of information. However, the National Safety Council has established some data associated with these costs in an attempt to identify a cost/benefit ratio. Some injury costs are in the public realm.

The most recent figures from the National Safety Council estimate that the total occupational death and injury cost in 1996 was \$121 billion. This figure includes wage and productivity losses of \$60.2 billion, medical costs of \$19.0 billion, and administrative expenses of \$25.6 billion. While this dollar figure is not specific to the electrical industry, it is staggering.

A paper presented at the IEEE Petroleum and Chemical Industry Conference in 1990 entitled *"Maintaining Safe Work Practices in a Competitive Environment"* contains information on costs. This paper, published in the IEEE Transactions in 1991, is available from the IEEE.

When an incident involving injury occurs, associated costs might be viewed as either direct costs or indirect costs. Direct costs include repair or replacement of the failed equipment and production loss due to the failure. Indirect costs include costs that are difficult to calculate.

Direct costs associated with an incident or injury might include:

- Equipment repair or replacement
- Lost production and employee down time

Indirect costs might include the following:

- Citation costs
- Incident investigation
- Creation and maintenance of documentation for legal purposes
- Insurance

- Ineffective work as employees talk about the incident and poor general morale
- Management reviews and reports

- Identification of procedural shortcomings and enacting "fixes"
- Litigation expenses
- Medical costs

Estimates of the ratio of direct to indirect costs are reported to vary from 1 to 4 on the low end to 1 to 8 on the upper end. Of course, legal expenses might be extreme should litigation result from the injury.

Employers are subject to inspection by field representatives from OSHA. Frequently, OSHA inspectors identify violations and assess fines. Most OSHA citations are small, in the hundreds of dollars. However, some are cited as serious violations. The Act (OSHA) does contain considerable "teeth". Section 666 provides that an employer can be issued a civil penalty of \$7,000 for a serious violation and up to \$70,000 for each willful or repeated violation of the Act. In addition, an employer can be liable under the Act for criminal sanctions, including monetary fines and imprisonment.

Lockout/tagout citations have declined in recent years, but every year the standard ranks as one of OSHA's most violated rules. Between October 1994 and June 1997, 10,272 violations of the standard were recorded. The total cost of these penalties: \$15 million.

To this point, this document has discussed only costs. Spending money now to avoid safety incidents and injuries avoids future expenditures. An effective safety program is the best possible legal defense. It is also the best way to document the employer's efforts, should the employer experience an OSHA inspection.

Dollars expended in an effective safety program are reported to be an excellent investment. In fact, money invested in a safety program reportedly results in a 400 percent return on investment (ROI).

In one instance, an electrical contractor was near bankruptcy. After a review of where the money was going, the contractor established an effective safety program. Although criticized for that "soft" expenditure, the result was a significant improvement in profitability. As the contractor's safety experience improved, the contractor's business increased dramatically, and overhead costs were significantly lowered. Safety is good business. Another large electrical contractor found that each serious electrical incident typically costs \$4 million.



XII. References

- Canadian Electrical Code, CSA C22.1-02.* Mississauga, Ontario, Canadian Standards Association, 2002.
- Doughty, R.L., T.E. Neal and H.L. Floyd II, "Predicting Incident Energy to Better Manage The Electrical Arc Hazard on 600 V Power Distribution Systems." Paper presented at the 45th Annual IAS/ IEEE Petroleum and Chemical Industry Conference, September 28-30, 1998.
- Doughty, R.L., T.E. Neal, Macalady, T.L., Saporita, V., and Borgwald, K., "The Use of Low-Voltage Current-Limiting Fuses to Reduce Arc-Flash Energy", IEEE Transactions on Industry Applications, Vol. 36, No. 6, November/December 2000
- Halliburton, Dan, "Flash Hazard Analysis and Methodology of Calculations." From the IEEE/PCIC Electrical Safety Workshop, February 6-8, 1996, San Antonio, TX.
- Jones, Ray A. and Jane G. Jones, *Electrical Safety in the Workplace.* Quincy, MA: National Fire Protection Association, 2000.
- Jones, R. A., Liggett, D., Capelli-Schellpfeffer, M., Macalady, T.L., Saunders, L.F., Downey, R. E., McClung, B., Smith, A., Jamil, S., and Saporita, V., "Staged Tests Increase Awareness of Arc-Flash Hazards in Electrical Equipment", IEEE Transactions on Industry Applications, Vol. 36, No. 2, March/April 2000
- Lee, R. H. "The Other Electrical Hazard: Electric Arc-blast Burns." IEEE Transactions, Vol. IA-18, No. 3, May/June 1982.
- Mastrullo, Kenneth G., Ray A. Jones, and Jane G. Jones, *The Electrical Safety Program Book.* Quincy, MA: National Fire Protection Association, 2003.
- National Electrical Code® (ANSI/NFPA 70).* Quincy, MA: National Fire Protection Association, 2002.
- Neitzel, Dennis, "Protective Devices Maintenance as It Applies to the Arc-flash Hazard", From the IEEE/PCIC Electrical Safety Workshop, February 5-7, 2003, Houston, TX,
- NFPA 70E, Standard for Electrical Safety in the Workplace.* Quincy, MA: National Fire Protection Association, 2004 (Available by calling 1-800-344-3555)
- OSHA Regulations 29 CFR 1910.300-399, Subpart S, "Electrical." Washington, DC: Occupational Safety and Health Administration, U. S. Department of Labor.
- OSHA Regulations 29 CFR 1926, Subpart K, "Electrical." Washington, DC: Occupational Safety and Health Administration, U. S. Department of Labor.
- "Protecting Yourself When Working On High-Power Circuits," *EC&M Magazine*, June 1997

XIII. Glossary of Terms

- Accessible.** Capable of being removed or exposed without damaging the building structure or finish, or not permanently closed in by the structure or finish of the building.
- Arc-blast.** The release of concentrated energy associated with extreme pressure and rapid pressure buildup resulting from an arcing fault.
- Arc-flash.** The release of concentrated (thermal) energy that is the result of an arcing fault.
- Arc-rating.** The maximum incident energy resistance demonstrated by a material (or a layered system of materials) prior to breakdown or at the onset of a second-degree skin burn. Arc rating is normally expressed in cal/cm².
- Branch Circuit.** The circuit conductor between the final overcurrent protection device protecting the circuit and the outlet(s).
- Controller.** A device or group of devices that serves to govern, in some predetermined manner, the electric power delivered to the apparatus to which it is connected.
- Dead Front.** Without live parts exposed to a person on the operating side of the equipment.
- De-energized.** Free from any electrical connection to a source of potential difference and from electrical charge; not having a potential different from that of the earth.
- Disconnecting Means.** A device, or group of devices, or other means by which the conductors of a circuit can be disconnected from their source of supply.
- Electrically Safe Work Condition.** A state in which the conductor or circuit part to be worked on or near has been disconnected from energized parts, locked/tagged in accordance with established standards, tested to ensure the absence of voltage, and grounded if determined necessary.
- Enclosure.** The case or housing of apparatus, or the fence or walls surrounding an installation to prevent personnel from accidentally contacting energized parts, or to protect the equipment from physical damage.
- Energized.** Electrically connected to or having a source of voltage.
- Equipment Grounding Conductor.** The conductor used to connect the non-current-carrying metal parts of equipment, raceways, and other enclosures to the system grounded conductor and/or the grounding electrode conductor of the circuit at the service equipment or at the source of a separately derived system.



Exposed (live parts). Capable of being inadvertently touched or approached nearer than a safe distance by a person. It is applied to parts that are not suitably guarded, isolated, or insulated.

Feeder. All circuit conductors between the service equipment, the source of a separately derived system, or other power supply source and the final branch-circuit overcurrent device.

Flash Hazard. A dangerous condition associated with the release of energy caused by an electric arc.

Flash Hazard Analysis. A study investigating a worker's potential exposure to arc-flash energy, conducted for the purpose of injury prevention and the determination of safe work practices and the appropriate levels of PPE.

Flash Protection Boundary. An approach limit at a distance from exposed live parts within which a person could receive a second-degree burn if an electrical arc-flash were to occur.

Grounded Conductor. A system or circuit conductor that is intentionally grounded. Note that all neutrals are grounded conductors but not all grounded conductors are neutrals.

Grounding Conductor. A conductor used to connect equipment or the grounded circuit of a wiring system to a grounding electrode or electrodes.

Guarded. Covered, shielded, fenced, enclosed, or otherwise protected by means of suitable covers, casings, barriers, rails, screens, mats, or platforms to remove the likelihood of approach or contact by persons or objects to a point of danger.

Isolated. Not readily accessible to persons unless special means for access are used.

Limited Approach Boundary (for shock). An approach limit at a distance from an exposed live part within which a shock hazard exists.

Overcurrent. Any current in excess of the rated current of equipment or the ampacity of a conductor. It might result from overload, short circuit, or ground fault.

Overload. Operation of equipment in excess of normal, full-load rating, or of a conductor in excess of rated ampacity that, when it persists for a sufficient length of time, would cause damage or dangerous overheating. A fault, such as a short circuit or ground fault, is not an overload.

Prohibited Approach Boundary (for shock). An approach limit at a distance from an exposed live part within which work is considered the same as making contact with the live part.

Qualified Person. A person who has sufficient training and experience on a particular type of electrical equipment to demonstrate to supervision that he or she is competent to complete the work to be done and is fully aware of the hazards involved.

Readily Accessible. Capable of being reached quickly for operation, renewal, or inspection, without requiring those to whom ready access is required to climb over or remove obstacles or to resort to portable ladders, chairs, etc.

Restricted Approach Boundary (for shock). An approach limit at a distance from an exposed live part within which there is an increased risk of shock, due to electrical arc-over combined with inadvertent movement, for personnel working in close proximity to the live part.

Switches.

- **General-Use Switch.** A switch intended for use in general distribution and branch circuits. It is rated in amps, and it is capable of interrupting its rated current at its rated voltage.
- **Isolation Switch.** A switch intended for isolating an electric circuit from the source of power. It has no interrupting rating, and it is intended to be operated only after the circuit has been opened by some other means.
- **Motor-Circuit Switch.** A switch, rated in horsepower, capable of interrupting the maximum locked-rotor current of a motor of the same horsepower rating as the switch at the rated voltage.

Switching Device. A device designed to close and/or open one or more electric circuits. Switching devices include the following:

- **Circuit Breakers.** A switching device capable of making, carrying, and breaking currents under normal circuit conditions, and also making, carrying for a specified time, and breaking currents under specified abnormal circuit conditions, such as those of short circuit.
- **Disconnecting (or isolating) Switch (disconnect, isolator).** A mechanical switching device used for isolating a circuit or equipment from a source of power.
- **Disconnecting Means.** A device, group of devices, or other means whereby the conductors of a circuit can be disconnected from their source of supply.
- **Interrupter Switch.** A switch capable of making, carrying, and interrupting specified currents.

Unqualified Person. A person who is not qualified to perform a certain work task.



Notes



Notes



XIV. Annexes

Annex A: Checklist for victims of electrical incidents*

This list should be a part of a site's emergency response plan for electrical injuries. A completed copy should accompany the victim to the hospital or treatment center if at all possible. The information will ensure the best possible evaluation and treatment by initial medical caregivers.

Name of injured person _____

1. When and where did the accident occur? _____

2. What was the victim doing at the time of the accident? _____

YES

NO

3. Did the victim come in direct contact with electricity?

Was an arc the source of electrical current exposure?

Explain. _____

4. Could the victim have inhaled metal vapors or extremely hot air caused by arc-flash?

5. What was the duration of exposure to electricity?

6. Please identify the following as related to the incident:

Voltage _____

Available short circuit current _____

Source of electrical hazard _____

7. Did the victim fall? If "yes," explain. _____

8. Was the victim wearing protective or insulated clothing, safety boots, or gloves?

If "yes," what protective equipment? _____

9. Were others involved in the accident?

If "yes," explain. _____

10. Before the accident, had the hazard been identified?

11. Did the victim seem dazed, confused, or lose consciousness at any point following the accident? If "yes," please elaborate.

12. Did the victim require CPR?

13. Was the victim treated as if bones might be broken, especially in the neck?

14. Did the accident involve an explosion?

15. Did the accident occur in a closed space? If "yes," please elaborate.

16. Did other hazards exist at the time of the accident, such as combustibles, heavy loads, moving or fixed machines, vehicles and equipment, or extreme ambient temperatures?

If "yes," explain. _____

17. Name and telephone number of person who can provide further information about the accident events.

* This checklist has been adapted from one originally developed by the Electrical Trauma Research Program, University of Chicago, Section of Plastic and Reconstructive Surgery.



Annex B: Sources of information

Where to Obtain Standards Information

Name of SDO	Address	Telephone No.	Internet URL
National Fire Protection Association (NFPA)	1 Batterymarch Park Quincy MA 02269-9101	1-800-344-3555	www.nfpa.org
Institute of Electrical and Electronics Engineers (IEEE)	445 Hoes Lane PO Box 1331 Piscataway, NJ 08855-1331	1-800-678-IEEE	www.ieee.org
Occupational Safety and Health Administration (OSHA) ¹			www.osha.gov
International Electro-technical Commission ²	11 W. 42nd Street New York, NY 10036	1-212-642-4900	www.iec.ch
National Electrical Manufacturers Association	Global 15 Inverness Way East Englewood, CO 80112-5776	1-800-854-7179	www.nema.org
American National Standards Institute	11 W. 42nd Street New York, NY 10036	1-212-642-8908	www.ansi.org
National Standards System Network ³			www.nssn.org
Underwriters Laboratory	333 Pfingsten Rd Northbrook, IL 60062	1-847-272-8400	www.ul.com

- ¹ OSHA maintains many offices throughout the United States. OSHA standards are available from many organizations and commercial outlets. All OSHA standards and OSHA-related information are available on the Worldwide Web. The OSHA Web site contains interpretive information in addition to all regulations.
- ² IEC standards are available from several outlets in the United States. A visit to the IEC Worldwide Web home page will provide information on all available outlets.
- ³ The National Standards System Network is a service provided by ANSI that supplies information on all ANSI-related standards developing organizations. All American National Standards are available for purchase through this network.

Annex C: OSHA and other standards for protective equipment

Table XIV(C)(1). List of OSHA Standards for Protective Equipment

OSHA 1910.38	Employee Emergency Plans and Fire Prevention Plans
OSHA 1910.95	Hearing Protection
OSHA 1910.132	Personal Protective Equipment-General Requirements
OSHA 1910.133	Eye and Face Protection
OSHA 1910.134	Respiratory Protection
OSHA 1910.135	Head Protection
OSHA 1910.136	Foot Protection
OSHA 1910.138	Hand Protection
OSHA 1910.146	Permit-Required Confined Spaces
OSHA 1910.147	Lockout/Tagout
OSHA 1910.151	Medical Services and First Aid
OSHA 1910.212	Machine Guarding
OSHA 1910.331-335	Electrical Protection
• 1910.331	• Scope
• 1910.332	• Training
• 1910.333	• Selection and Use of Work Practices
• 1910.334	• Use of Equipment
• 1910.335	• Safeguards for Personnel Protection

Table XIV(C)(2). Standards on Protective Equipment (Table 130.7(C)(8) in NFPA 70E)

Subject Number and Title	
Head Protection	ANSI Z89.1, Requirements for Protective Headwear for Industrial Workers, 1997
Eye and Face Protection	ANSI Z87.1, Practice for Occupational and Educational Eye and Face Protection, 1998
Gloves	ASTM D120, Standard Specification for Rubber Insulating Gloves, 2002
Sleeves	ASTM D1051, Standard Specification for Rubber Insulating Sleeves, 2002
Gloves and Sleeves	ASTM F496, Standard Specification for In-Service Care of Insulating Gloves and Sleeves, 2002
Leather Protectors	ASTM F696, Standard Specification for Leather Protectors for Rubber Insulating Gloves and Mittens, 2002
Footwear	ASTM F1117, Standard Specification for Dielectric Overshoe Footwear, 1998
	ASTM Z41, Standard for Personnel Protection, Protective Footwear, 1991
Visual Inspection	ASTM F1236, Standard Guide for Visual Inspection of Electrical Protective Rubber Products, 1996
Apparel	ASTM F1506, Standard Specification for Protective Wearing Apparel for Use by Electrical Workers When Exposed to Momentary Electric Arc and Related Thermal Hazards, 2002
Face Protective Products	ASTM F2178, Standard Test Method for Determining the Arc-Flash Rating of Face Protective Products, 2002

ANSI—American National Standards Institute

ASTM—American Society for Testing and Materials



Table XIV(C)(3). Standards on Other Protective Equipment (Table 130.7(F) in NFPA 70E)

Subject Number and Title	
Safety Signs and Tags	ANSI Z535, Series of Standards for Safety Signs and Tags, 2002
Blankets	ASTM D1048 Standard Specification for Rubber Insulation Blankets, 1998
Covers	ASTM D1049, Standard Specification for Rubber Covers, 1998
Line Hoses	ASTM D1050, Standard Specification for Rubber-Insulating Line Hoses, 1990
Line Hoses and Covers	ASTM F478, Standard Specification for In-Service Care of Insulating Line Hoses and Covers, 1999
Blankets	ASTM F479, Standard Specification for In-Service Care of Insulating Blankets, 1995
Fiberglass Tools/Ladders	ASTM F711, Standard Specification for Fiberglass-Reinforced Plastic (FRP) Rod and Tube Used in Live Line Tools, 1997
Plastic Guards	ASTM F712, Test Methods for Electrically Insulating Plastic Guard Equipment for Protection of Workers, 1995
Temporary Grounding	ASTM F855, Standard Specification for Temporary Grounding Systems to Be Used on Deenergized Electric Power Lines and Equipment, 1997
Insulated Hand Tools	ASTM F1505, Specification for Insulated Hand Tools, 1994

ANSI—American National Standards Institute ASTM—American Society for Testing and Materials

Note: *The standards contained in Table XIV(C)(3) are the base standard used by OSHA to generate 29 CFR 1910.137- Personal Protective Equipment. The same information served as the basis for 29 CFR 1910.269 (generation, transmission, and distribution).*

Annex D: Listing of IEEE standards: color books

The Color Book Series by the Institute of Electrical and Electronic Engineers (IEEE) provides recommended practices and guidelines that go beyond the minimum requirements of the NEC®, NEMA, and UL standards. When designing electrical power systems for industrial and commercial facilities, consideration should be given to the design and safety requirements of the following IEEE color books:

Red Book	<i>IEEE Recommended Practice for Electrical Power Distribution for Industrial Plants</i>
Green Book	<i>IEEE Recommended Practice for Grounding of Industrial and Commercial Power Systems</i>
Gray Book	<i>IEEE Recommended Practice for Electrical Power Systems in Commercial Buildings</i>
Brown Book	<i>IEEE Recommended Practice for Power System Analysis</i>
Buff Book	<i>IEEE Recommended Practice Protection and Coordination of Industrial and Commercial Power Systems</i>
Orange Book	<i>IEEE Recommended Practice for Emergency and Standby Power Systems for Industrial and Commercial Applications</i>
Gold Book	<i>IEEE Recommended Practice for the Design of Reliable Industrial and Commercial Power</i>
White Book	<i>IEEE Recommended Practice for Electrical Systems in Health Care Facilities</i>
Bronze Book	<i>IEEE Recommended Practice for Electrical Conservation and Cost-Effective Planning in Industrial Plants</i>
Emerald Book	<i>IEEE Recommended Practice for Powering and Grounding Sensitive Electronic Equipment</i>
Yellow Book	<i>IEEE Guide to Operation, Maintenance and Safety of Industrial and Commercial Power Systems</i>
Blue Book	<i>IEEE Recommended Practice for Applying Low-Voltage Circuit Breakers Used in Industrial and Commercial Power Systems</i>



Annex E: The Safety BASICS™ Safety Awareness Quiz

Date: _____

Name: _____

Title: _____

Company: _____

- The American National Standards Institute writes its own standards.
A. True B. False
- The actions of people account for what percentage of incidents that result in injury?
A. 25% B. 50% C. 75% D. 100%
- Which of the following is the *National Electrical Code*®?
A. *NFPA 70* B. *NFPA 70B* C. *NFPA 70E*
D. *NFPA 73*
- Compliance with the NEC® is all that is required to assure a safe and dependable system.
A. True B. False
- OSHA violations can result in jail time for employers.
A. True B. False
- NFPA 70E* suggests the following:
A. Electrical hazards include shock, arc-flash, and blast.
B. The best way to avoid injury or incident is to establish an electrically safe work condition.
C. Procedures and training are extremely important if injury is to be avoided.
D. All of the above.
- Which standard covers “electrical equipment maintenance”?
A. NFPA 79 B. IEC 947-4-1
C. NESC D. NFPA 70B
- Training records should be kept for legal reasons.
A. True B. False
- Every employee working with electricity must be able to provide CPR.
A. True B. False
- Of those people who were electrocuted on low-voltage systems (600V and below), approximately what percentage were working on energized equipment?
A. 25% B. 50% C. 75% D. 100%
- In an electrical incident, what happens when the skin is broken?
A. The body’s resistance goes down, exposing the body to greater current.
B. The body’s resistance goes down, exposing the body to less current.
C. The body’s resistance goes up, exposing the body to greater current.
D. The body’s resistance goes up, exposing the body to less current.
- The “let-go” threshold refers to which of the following?
A. The amount of current that causes the hand to let-go of an energized part
B. The amount of voltage that causes the hand to let-go of an energized part
C. The amount of current that causes the hand to be unable to let-go of an energized part
D. The amount of voltage that causes the hand to be unable to let-go of an energized part
- Tissue and organs can burn at currents of 1.5 amps.
A. True B. False
- The temperature at the terminal of an arc can reach which of the following?
A. One-half the temperature of the surface of the sun
B. The temperature of the surface of the sun
C. Almost twice the temperature of the surface of the sun
D. Almost four times the temperature of the surface of the sun
- Skin exposed to a temperature of 200°F for one second will be unhurt.
A. True B. False
- When it vaporizes, copper expands by a factor of which of the following?
A. 1,670 times C. 167,000 times
B. 67,000 times D. None of the above
- Facilities should know, before an electrical incident ever occurs, which medical facilities specialize in electrical trauma.
A. True B. False
- When coming to the aid of an electrical incident victim, which of the following is the first action of the rescuer should perform?
A. Call OSHA.
B. Apply first aid.
C. Treat for shock.
D. Make sure the power is off.
- If the victim’s pulse or breathing has stopped, in length of time can brain damage occur?
A. One minute
B. Two to three minutes
C. Four to six minutes
D. Eight to ten minutes
- Who must provide a safe workplace?
A. Employers
B. Employees
C. Both employers and employees
- Who is responsible for implementing the safety program and procedures?
A. Employers
B. Employees
- In which of the following was the concept of an electrically safe work condition introduced?
A. NFPA 70 B. NFPA 70B C. *NFPA 70E* D. OSHA
- After determining that the circuit is de-energized, it is never necessary to use grounding straps.
A. True B. False
- Any person within the prohibited approach boundary must be qualified.
A. True
B. False
- What is the maximum allowable product of overcurrent protective device clearing time and available fault current to use the flash protection boundary of 4 feet from 70E-130.3(A)?
A. 50kA B. 50kA cycles
C. 300kA cycles D. 5000kA cycles



26. What is the maximum short-circuit current and overcurrent protective device clearing time that will allow the use of 70E-Table 130.7(C)(9)(a) to determine the hazard risk category for an MCC?
- 25kA short circuit current available, 0.03 second (2 cycle) fault clearing time
 - 25kA short circuit current available, 0.33 second (20 cycle) fault clearing time
 - 65kA short circuit current available, 0.03 second (2 cycle) fault clearing time
 - 65kA short circuit current available, 0.33 second (20 cycle) fault clearing time
27. For arcing faults within their current-limiting range, current-limiting protective devices can:
- Limit the magnitude and duration of arcing faults
 - Reduce the flash protection boundary
 - Reduce the incident energy
 - All of the above
28. If an arc could be initiated on the line side of a 30A switch with 10A fuses, the Flash Hazard Analysis should be based upon the device (and opening time) of the overcurrent device that feeds the disconnect.
- True
 - False
29. For the circuit described in the previous question, the Flash Hazard Analysis could be based upon the 10A fuse if work were planned for a downstream controller ten feet away.
- True
 - False
30. Flash protection boundary and incident energy needs only to be considered at the maximum available fault current.
- True
 - False
31. Any part of a person's body within a flash protection boundary must be protected with appropriate personal protective equipment, such as flame resistant clothing.
- True
 - False
32. Tagout must be used unless the employer can demonstrate that the use of a lockout system can provide full employee protection.
- True
 - False
33. A circuit can shock you even if all external sources of power have been removed.
- True
 - False
34. Which rating provides the greater protection against electrical shock?
- IP1X
 - IP2X
 - IP0X
 - IP3X
35. Sizing an equipment grounding conductor according to Table 250.122 of the 2002 NEC® ensures an adequate, safe ground return path.
- True
 - False
36. The use of a disconnecting means at every motor, even where not required,
- Is a waste of money
 - Creates confusion during an electrical incident
 - Provides a quick means of de-energizing
 - Creates confusion and provides a quick means of de-energizing
37. An Energized Electrical Work Permit shall include the following:
- The available fault current
 - The results of the Flash Hazard Analysis
 - Signed approval from an authorized person
 - A and B
 - B and C
38. Which NEC® Section covers requirements for arc-flash warning labels?
- 110.9
 - 110.16
 - 240.85
 - 430.52
39. For overcurrent protective devices that require maintenance, failure to perform maintenance can lead to the following:
- Longer clearing times
 - Increased flash protection boundaries
 - Higher incident energies
 - All of the above
40. All current-limiting overcurrent protective devices provide the same level of protection
- True
 - False
41. Class RK1 fuses can replace Class H and Class RK5 fuses as a possible means to improve electrical safety.
- True
 - False
42. Short-time delay settings on circuit breakers should be used to reduce the arc-flash hazard.
- True
 - False
43. Arc resistant switchgear can be used to prevent arcing faults.
- True
 - False
44. What kind of costs are litigation expenses?
- Direct costs
 - Indirect costs
45. It is a violation of OSHA 1910.334(b)(2) for a machine operator to reset a circuit breaker without knowing if it was a short circuit or an overload that caused the breaker to trip.
- True
 - False

Annex F: 3Ø Short-Circuit Calculation Method

General Comments on Short-Circuit Calculations

Normally, short-circuit studies involve calculating a bolted 3-phase fault condition. This can be characterized as all 3-phases "bolted" together to create a zero impedance connection. This establishes a "worst case" (highest current) condition that results in maximum three phase thermal and mechanical stress in the system. This "worst case" condition should be used for interrupting rating, component protection and selective coordination. However, in doing an arc-flash hazard analysis it is recommended to do the arc-flash hazard analysis at the highest bolted 3 phase short-circuit condition and at the "minimum" bolted three-phase short-circuit condition. There are several variables in a distribution system that affect calculated bolted 3-phase short-circuit currents. It is important to select the variable values applicable for the specific application analysis. The variables are utility source short-circuit capabilities, motor contribution, transformer percent impedance tolerance, and voltage variance; see notes and footnotes.

Procedures and Methods

The impedance tables include three-phase transformers, cable, and busway. These tables can be used if information from the manufacturers is not readily available.

It must be understood that short-circuit calculations are performed without current-limiting devices in the system. Calculations are done as though these devices are replaced with copper bars, to determine the maximum "available" short-circuit current.

Also, multiple current-limiting devices do not operate in series to produce a "compounding" current-limiting effect. The downstream or load side fuse will operate alone under a short-circuit condition if properly coordinated.

This method can assume unlimited primary short-circuit current (infinite bus) or it can be used with limited primary available current.

Basic Point-to-Point Calculation Procedure

Step 1. Determine the transformer full load amperes (F.L.A.) from either the nameplate, the following formula or Table 3:

$$3\text{Ø Transformer } I_{F.L.A.} = \frac{\text{KVA} \times 1000}{E_{L-L} \times 1.732}$$

Step 2. Find the transformer multiplier. See Notes 1 and 2

$$\text{Multiplier} = \frac{100}{\%Z_{\text{transformer}}}$$

Note 1. Get %Z from nameplate or Table 3. Transformer impedance (Z) helps to determine what the short circuit current will be at the transformer secondary.

Note 2. In addition, UL (Std. 1561) listed transformers 25KVA and larger have a ± 10% impedance tolerance. Short circuit amperes can be affected by this tolerance. Therefore, for high end worst case, multiply %Z by 0.9. For low end of worst case, multiply %Z by 1.1. Transformers constructed to ANSI standards have a ±7.5% impedance tolerance (two-winding construction).

Step 3. Determine by formula below or Table 3 the transformer let-through short-circuit current. See Notes 3 and 4.

$$I_{S.C.} = \text{Transformer } I_{F.L.A.} \times \text{Multiplier}$$

Note 3. Utility voltages may vary ±10% for power, therefore, for highest short-circuit conditions, multiply values as calculated in step 3 by 1.1. To find the lower end worst case, multiply results in step 3 by 0.9.

Note 4. Motor short-circuit contribution, if significant, may be added at all fault locations throughout the system. A practical estimate of motor short-circuit contribution is to multiply the total motor current in amperes by 4. Values of 4 to 6 are commonly accepted.

Step 4. Calculate the "f" factor for 3Ø Faults.

$$f = \frac{1.732 \times L \times I_{3\text{Ø}}}{C \times n \times E_{L-L}}$$

Where:

- L = length (feet) of conductor to the fault.
- C = constant from Table 2 of "C" values for conductors and Table 1 of "C" values for busway.
- n = number of conductors per phase (adjusts C value for parallel runs)

I = available short-circuit current in amperes at beginning of circuit.

Step 5. Calculate "M" (multiplier). $M = \frac{1}{1+f}$

Step 6. Calculate the available short-circuit symmetrical RMS current at the point of fault. Add motor contribution, if applicable.

$$I_{S.C. \text{ sym RMS}} = I_{S.C.} \times M$$

Step 6A. Motor short-circuit contribution, if significant, may be added at all fault locations throughout the system. A practical estimate of motor short-circuit contribution is to multiply the total motor current in amperes by 4. Values of 4 to 6 are commonly accepted.

Calculation of Short-Circuit Currents at Second Transformer in System

Use the following procedure to calculate the level of fault current at the secondary of a second, downstream transformer in a system when the level of fault current at the transformer primary is known.

Procedure for Second Transformer in System

Step A. Calculate the "f" factor ($I_{S.C. \text{ primary}}$ known)

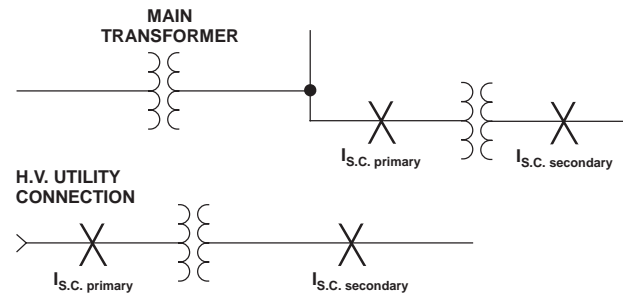

3Ø Transformer
($I_{S.C. \text{ primary}}$ and
 $I_{S.C. \text{ secondary}}$ are
3Ø fault values)

$$f = \frac{I_{S.C. \text{ primary}} \times V_{\text{primary}} \times 1.73 (\%Z)}{100,000 \times \text{KVA}_{\text{transformer}}}$$

Step B. Calculate "M" (multiplier). $M = \frac{1}{1+f}$

Step C. Calculate the short-circuit current at the secondary of the transformer. (See Note under Step 3.)

$$I_{S.C. \text{ secondary}} = \frac{V_{\text{primary}}}{V_{\text{secondary}}} \times M \times I_{S.C. \text{ primary}}$$

Table 1. "C" Values for Busway

Ampacity	Busway				
	Plug-In		Feeder		High Impedance
	Copper	Aluminum	Copper	Aluminum	Copper
225	28700	23000	18700	12000	—
400	38900	34700	23900	21300	—
600	41000	38300	36500	31300	—
800	46100	57500	49300	44100	—
1000	69400	89300	62900	56200	15600
1200	94300	97100	76900	69900	16100
1350	119000	104200	90100	84000	17500
1600	129900	120500	101000	90900	19200
2000	142900	135100	134200	125000	20400
2500	143800	156300	180500	166700	21700
3000	144900	175400	204100	188700	23800
4000	—	—	277800	256400	—

Note: These values are equal to one over the impedance per foot for impedance in a survey of industry.



Table 2. "C" Values for Conductors

Copper							Aluminum						
AWG or kcmil	Three Single Conductors or Conduit Steel						AWG or kcmil	Three Single Conductors or Conduit Steel					
	Nonmagnetic			Nonmagnetic				Nonmagnetic			Nonmagnetic		
	600V	5kV	15kV	600V	5kV	15kV		600V	5kV	15kV	600V	5kV	15kV
14	389	-	-	389	-	-	14	237	-	-	237	-	-
12	617	-	-	617	-	-	12	376	-	-	376	-	-
10	981	-	-	982	-	-	10	599	-	-	599	-	-
8	1557	1551	-	1559	1555	-	8	951	950	-	952	951	-
6	2425	2406	2389	2430	2418	2407	6	1481	1476	1472	1482	1479	1476
4	3806	3751	3696	3826	3789	3753	4	2346	2333	2319	2350	2342	2333
3	4774	4674	4577	4811	4745	4679	3	2952	2928	2904	2961	2945	2929
2	5907	5736	5574	6044	5926	5809	2	3713	3670	3626	3730	3702	3673
1	7293	7029	6759	7493	7307	7109	1	4645	4575	4498	4678	4632	4580
1/0	8925	8544	7973	9317	9034	8590	1/0	5777	5670	5493	5838	5766	5646
2/0	10755	10062	9390	11424	10878	10319	2/0	7187	6968	6733	7301	7153	6986
3/0	12844	11804	11022	13923	13048	12360	3/0	8826	8467	8163	9110	8851	8627
4/0	15082	13606	12543	16673	15351	14347	4/0	10741	10167	9700	11174	10749	10387
250	16483	14925	13644	18594	17121	15866	250	12122	11460	10849	12862	12343	11847
300	18177	16293	14769	20868	18975	17409	300	13910	13009	12193	14923	14183	13492
350	19704	17385	15678	22737	20526	18672	350	15484	14280	13288	16813	15858	14955
400	20566	18235	16366	24297	21786	19731	400	16671	15355	14188	18506	17321	16234
500	22185	19172	17492	26706	23277	21330	500	18756	16828	15657	21391	19503	18315
600	22965	20567	17962	28033	25204	22097	600	20093	18428	16484	23451	21718	19635
750	24137	21387	18889	29735	26453	23408	750	21766	19685	17686	25976	23702	21437
1,000	25278	22539	19923	31491	28083	24887	1,000	23478	21235	19006	28779	26109	23482

Note: These values are equal to one over the impedance per foot and based upon resistance and reactance values found in IEEE Std 241-1990 (Gray Book), IEEE Recommended Practice for Electric Power Systems in Commercial Buildings & IEEE Std 242-1986 (Buff Book), IEEE Recommended Practice for Protection and Coordination of Industrial and Commercial Power Systems. Where resistance and reactance values differ or are not available, the Buff Book values have been used. The values for reactance in determining the C Value at 5 kV & 15 kV are from the Gray Book only (Values for 14-10 AWG at 5 kV and 14-8 AWG at 15 kV are not available and values for 3 AWG have been approximated).

TRANSFORMERS

Table 3. Short-Circuit Currents Available from Various Size Transformers

(Based upon actual field nameplate data or from utility transformer worst case impedance)

Voltage and Phase	KVA	Full Load Amps	% Impedance† (Nameplate)	Short Circuit Amps*	Voltage and Phase	KVA	Full Load Amps	% Impedance† (Nameplate)	Short Circuit Amps*
120/208 3 ph.**	45	125	1.0	13879	277/480 3 ph.**	75	90	1.00	10035
	75	208	1.0	23132		112.5	135	1.00	15053
	112.5	312	1.11	31259		150	181	1.20	16726
	150	416	1.07	43237		225	271	1.20	25088
	225	625	1.12	61960		300	361	1.20	33451
	300	833	1.11	83357		500	602	1.30	51463
	500	1388	1.24	124364		750	903	3.50	28672
	750	2082	3.50	66091		1000	1204	3.50	38230
	1000	2776	3.50	88121		1500	1806	3.50	57345
	1500	4164	3.50	132181		2000	2408	4.00	66902
2000	5552	4.00	154211	2500	3011	4.00	83628		
2500	6940	4.00	192764						

**Three-phase short-circuit currents based on "infinite" primary.

††UL listed transformers 25 KVA or greater have a ±10% impedance tolerance. Short-circuit amps shown in Table 1 reflect -10% condition. Transformers constructed to ANSI standards have a ±7.5% impedance tolerance (two-winding construction).

†Fluctuations in system voltage will affect the available short-circuit current. For example, a 10% increase in system voltage will result in a 10% greater available short-circuit currents than as shown in Table 1.

Example

Available Utility Infinite Assumption
1500 KVA Transformer,
480V, 3Ø, 3.5%Z,
3.45%X, .56%R
I_{rL} = 1804A
25' - 500kcmil
6 Per Phase
Service Entrance
Conductors in Steel Conduit

2000A Switch
KRP-C-2000SP Fuse

Fault X₁

400A Switch

LPS-RK-400SP Fuse

50' - 500 kcmil
Feeder Cable
in Steel Conduit

Fault X₂
Motor Contribution

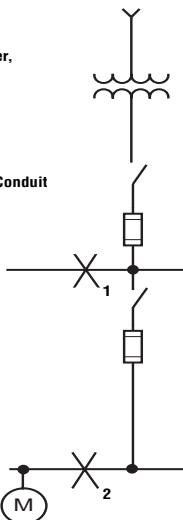

Fault X₁

Step 1. $I_{rL} = \frac{1500 \times 1000}{480 \times 1.732} = 1804A$

Step 2. **Multiplier = $\frac{100}{3.5} = 28.57$**

Step 3. $I_{s.c.} = 1804 \times 28.57 = 51,540A$

$I_{s.c. \text{ motor contrib}} = 4 \times 1,804^* = 7,216A$

$I_{\text{total s.c. sym RMS}} = 51,504 + 7,216 = 58,720A$

Step 4. $f = \frac{1.732 \times 25 \times 51,540}{22,185 \times 6 \times 480} = 0.0349$

Step 5. $M = \frac{1}{1 + .0349} = .9663$

Step 6. $I_{s.c. \text{ sym RMS}} = 51,540 \times .9663 = 49,803A$

$I_{s.c. \text{ motor contrib}} = 4 \times 1,804^* = 7,216A$

$I_{\text{total s.c. sym RMS}} = 49,803 + 7,216 = 57,019A$
 (fault X₁)

Fault X₂

Step 4. Use $I_{s.c. \text{ sym RMS}}$ @ Fault X₁ to calculate "f"

$f = \frac{1.732 \times 50 \times 49,803}{22,185 \times 480} = .4050$

Step 5. $M = \frac{1}{1 + .4050} = .7117$

Step 6. $I_{s.c. \text{ sym RMS}} = 49,803 \times .7117 = 35,445A$

$I_{\text{sym motor contrib}} = 4 \times 1,804^* = 7,216A$

$I_{\text{total s.c. sym RMS}} = 35,445 + 7,216 = 42,661A$
 (fault X₂)

*Assumes 100% motor load. If 50% of this load was from motors, $I_{s.c. \text{ motor contrib}} = 4 \times 1,804 \times .5 = 3608A$



Annex G Arc-Flash Calculator

Steps necessary to conduct a Flash Hazard Analysis.

1. Determine the available bolted fault current on the line side terminals of the equipment that will be worked upon.
2. Identify the amperage of the upstream LOW-PEAK® fuse or circuit breaker that is protecting the equipment where work is to be performed.
3. Consult the table to determine the incident energy exposure and the flash protection boundary.
4. Identify the minimum requirements for PPE when work is to be performed inside of the FPB by consulting the requirements found in *NFPA 70E*.

Notes for Arc-Flash Calculation Tables:

Note 1: First and foremost, this information is not to be used as a recommendation to work on energized equipment. This information is to help assist in determining the proper PPE to help safeguard a worker from the burns that can be sustained from an arc-flash incident. This information does not take into account the effects of pressure, shrapnel, molten metal spray, or the toxic copper vapor resulting from an arc-fault.

Note 2: This data is based upon IEEE Guide for Arc-flash Hazard Analysis, 1584. These methods were created so that the PPE selected from the calculated incident energy would be adequate for 98% of arc-flash incidents. In up to 2% of incidents, incurable burns to the body and torso could result. This was based upon PPE with standard arc ratings of 1.2, 8, 25, 40 and 100cal/cm². PPE with intermediate ATPV values can be utilized, but at the next lower standard ATPV rating.

Note 3: PPE must be utilized any time that work is to be performed on or near energized electrical equipment or equipment that could become energized. Voltage testing, while completing the lockout/tagout procedure (putting the equipment in an electrically safe work condition), is considered as working on energized parts per OSHA 1910.333(b).

Note 4: The data is based on 32mm (1¼") electrode spacing, 600V 3Ø ungrounded system, and 20" by 20" by 20" box. The incident energy is based on a working distance of 18 inches, and the flash protection boundary is based on 1.2cal/cm².

Note 5: The LOW-PEAK® fuse information is based upon tests that were conducted at various fault currents for each Bussmann® KRP-C_SP and LPS-RK_SP fuse indicated in the charts. Actual results from incidents could be different for a number of reasons, including different (1) system voltage, (2) short-

circuit power factor, (3) distance from the arc, (4) arc gap, (5) enclosure size, (6) fuse manufacturer, (7) fuse class, (8) orientation of the worker and (9) grounding scheme. 100A LPS-RK_SP fuses were the smallest fuses tested. Data for the fuses smaller than that is based upon the 100A data. Arc-flash values for actual 30 and 60A fuses would be considerably less than 100A fuses, however, it does not matter since the values for the 100A fuses are already so low.

Note 6: The fuse incident energy values were chosen not to go below 0.25cal/cm² even though many actual values were below 0.25cal/cm². This was chosen to keep from encouraging work on energized equipment without PPE because of a low FPB.

Note 7: This slide rule can also be used for LPJ_SP, JJS, and LP-CC fuses to determine the incident energy available and flash protection boundary.

Note 8: These values from fuse tests and calculations for circuit breakers take into account the translation from available 3-phase bolted fault current to the arcing fault current.

Note 9: To determine the flash protection boundary and incident energy for applications with other fuses, use the equations in IEEE 1584 or *NFPA 70E*.

Note 10: The circuit breaker information comes from equations in IEEE 1584 that are based upon how circuit breakers operate.

Note 11: Where the arcing current is less than the instantaneous trip setting (IEEE 1584 calculation methods), the value for incident energy is given as >100cal/cm².

Note 12: The data for circuit breakers up to 400A is based on Molded Case Circuit Breakers (MCCB) with instantaneous trip, for 401-600A it is based on MCCBs with electronic trip units, and the data for circuit breakers from 601 up to 2000A is based on Low Voltage Power Circuit Breakers (LVPCB) with a short time delay. Per IEEE 1584 the short time delay is assumed to be set at maximum.

Note 13: The data for circuit breakers is based upon devices being properly maintained in accordance with manufacturer's instructions and industry standards. Devices that are not properly maintained and tested may have longer clearing times resulting in higher incident energies.

For further explanation please consult the SPD Electrical Protection Handbook available at www.bussmann.com.



Arc-Flash Incident Energy Calculator

Fuses: Bussmann® LOW-PEAK® LPS-RK_SP (0-600A), Circuit Breakers: Molded Case Circuit Breakers

Incident Energy (I.E.) values are expressed in cal/cm². Flash Protection Boundary (FPB) values are expressed in inches.

Bolted Fault Current (kA)	1-100A				101-200A				201-400A				401-600A			
	Fuse		MCCB		Fuse		MCCB		Fuse		MCCB		Fuse		MCCB	
	I.E.	FPB	I.E.	FPB	I.E.	FPB	I.E.	FPB	I.E.	FPB	I.E.	FPB	I.E.	FPB	I.E.	FPB
1	2.39	29	>100	>120	>100	>120	>100	>120	>100	>120	>100	>120	>100	>120	>100	>120
2	0.25	6	0.25	6	5.20	49	>100	>120	>100	>120	>100	>120	>100	>120	>100	>120
3	0.25	6	0.27	7	0.93	15	>100	>120	>100	>120	>100	>120	>100	>120	>100	>120
4	0.25	6	0.35	8	0.25	6	0.35	8	20.60	124	>100	>120	>100	>120	>100	>120
5	0.25	6	0.43	9	0.25	6	0.43	9	1.54	21	>100	>120	>100	>120	>100	>120
6	0.25	6	0.50	10	0.25	6	0.50	10	0.75	13	>100	>120	>100	>120	>100	>120
8	0.25	6	0.65	12	0.25	6	0.65	12	0.69	12	0.65	12	36.85	184	>100	>120
10	0.25	6	0.81	14	0.25	6	0.81	14	0.63	12	0.81	14	12.82	90	>100	>120
12	0.25	6	0.96	15	0.25	6	0.96	15	0.57	11	0.96	15	6.71	58	1.70	23
14	0.25	6	1.11	17	0.25	6	1.11	17	0.51	10	1.11	17	0.60	11	1.96	25
16	0.25	6	1.26	19	0.25	6	1.26	19	0.45	9	1.26	19	0.59	11	2.22	27
18	0.25	6	1.41	20	0.25	6	1.41	20	0.39	8	1.41	20	0.48	10	2.48	29
20	0.25	6	1.56	22	0.25	6	1.56	22	0.33	7	1.56	22	0.38	8	2.74	32
22	0.25	6	1.72	23	0.25	6	1.72	23	0.27	7	1.72	23	0.28	7	3.00	34
24	0.25	6	1.87	24	0.25	6	1.87	24	0.25	6	1.87	24	0.25	6	3.26	36
26	0.25	6	2.02	26	0.25	6	2.02	26	0.25	6	2.02	26	0.25	6	3.53	37
28	0.25	6	2.17	27	0.25	6	2.17	27	0.25	6	2.17	27	0.25	6	3.79	39
30	0.25	6	2.32	28	0.25	6	2.32	28	0.25	6	2.32	28	0.25	6	4.05	41
32	0.25	6	2.47	29	0.25	6	2.47	29	0.25	6	2.47	29	0.25	6	4.31	43
34	0.25	6	2.63	31	0.25	6	2.63	31	0.25	6	2.63	31	0.25	6	4.57	45
36	0.25	6	2.78	32	0.25	6	2.78	32	0.25	6	2.78	32	0.25	6	4.83	46
38	0.25	6	2.93	33	0.25	6	2.93	33	0.25	6	2.93	33	0.25	6	5.09	48
40	0.25	6	3.08	34	0.25	6	3.08	34	0.25	6	3.08	34	0.25	6	5.36	50
42	0.25	6	3.23	35	0.25	6	3.23	35	0.25	6	3.23	35	0.25	6	5.62	51
44	0.25	6	3.38	36	0.25	6	3.38	36	0.25	6	3.38	36	0.25	6	5.88	53
46	0.25	6	3.54	37	0.25	6	3.54	37	0.25	6	3.54	37	0.25	6	6.14	55
48	0.25	6	3.69	39	0.25	6	3.69	39	0.25	6	3.69	39	0.25	6	6.40	56
50	0.25	6	3.84	40	0.25	6	3.84	40	0.25	6	3.84	40	0.25	6	6.66	58
52	0.25	6	3.99	41	0.25	6	3.99	41	0.25	6	3.99	41	0.25	6	6.92	59
54	0.25	6	4.14	42	0.25	6	4.14	42	0.25	6	4.14	42	0.25	6	7.18	61
56	0.25	6	4.29	43	0.25	6	4.29	43	0.25	6	4.29	43	0.25	6	7.45	62
58	0.25	6	4.45	44	0.25	6	4.45	44	0.25	6	4.45	44	0.25	6	7.71	64
60	0.25	6	4.60	45	0.25	6	4.60	45	0.25	6	4.60	45	0.25	6	7.97	65
62	0.25	6	4.75	46	0.25	6	4.75	46	0.25	6	4.75	46	0.25	6	8.23	67
64	0.25	6	4.90	47	0.25	6	4.90	47	0.25	6	4.90	47	0.25	6	8.49	68
66	0.25	6	5.05	48	0.25	6	5.05	48	0.25	6	5.05	48	0.25	6	8.75	69
68	0.25	6	5.20	49	0.25	6	5.20	49	0.25	6	5.20	49	0.25	6	9.01	71
70	0.25	6	5.36	50	0.25	6	5.36	50	0.25	6	5.36	50	0.25	6	9.28	72
72	0.25	6	5.51	51	0.25	6	5.51	51	0.25	6	5.51	51	0.25	6	9.54	74
74	0.25	6	5.66	52	0.25	6	5.66	52	0.25	6	5.66	52	0.25	6	9.80	75
76	0.25	6	5.81	53	0.25	6	5.81	53	0.25	6	5.81	53	0.25	6	10.06	76
78	0.25	6	5.96	53	0.25	6	5.96	53	0.25	6	5.96	53	0.25	6	10.32	78
80	0.25	6	6.11	54	0.25	6	6.11	54	0.25	6	6.11	54	0.25	6	10.58	79
82	0.25	6	6.27	55	0.25	6	6.27	55	0.25	6	6.27	55	0.25	6	10.84	80
84	0.25	6	6.42	56	0.25	6	6.42	56	0.25	6	6.42	56	0.25	6	11.10	82
86	0.25	6	6.57	57	0.25	6	6.57	57	0.25	6	6.57	57	0.25	6	11.37	83
88	0.25	6	6.72	58	0.25	6	6.72	58	0.25	6	6.72	58	0.25	6	11.63	84
90	0.25	6	6.87	59	0.25	6	6.87	59	0.25	6	6.87	59	0.25	6	11.89	85
92	0.25	6	7.02	60	0.25	6	7.02	60	0.25	6	7.02	60	0.25	6	12.15	87
94	0.25	6	7.18	61	0.25	6	7.18	61	0.25	6	7.18	61	0.25	6	12.41	88
96	0.25	6	7.33	61	0.25	6	7.33	61	0.25	6	7.33	61	0.25	6	12.67	89
98	0.25	6	7.48	62	0.25	6	7.48	62	0.25	6	7.48	62	0.25	6	12.93	90
100	0.25	6	7.63	63	0.25	6	7.63	63	0.25	6	7.63	63	0.25	6	13.20	92
102	0.25	6	7.78	64	0.25	6	7.78	64	0.25	6	7.78	64	0.25	6	13.46	93
104	0.25	6	7.93	65	0.25	6	7.93	65	0.25	6	7.93	65	0.25	6	13.72	94
106	0.25	6	8.09	66	0.25	6	8.09	66	0.25	6	8.09	66	0.25	6	13.98	95

Read attached notes. Fuse results are based on actual test data.

Circuit breaker results are based upon IEEE 1584 calculations; if circuit breakers are not properly maintained values can be considerably greater.



www.bussmann.com
For more on Electrical Safety.

Arc-Flash Incident Energy Calculator

Fuses: Bussmann® LOW-PEAK® KRP-C_SP (601-2000A), Circuit Breakers: Low Voltage Power Circuit Breakers (w/STD)

Incident Energy (I.E.) values are expressed in cal/cm². Flash Protection Boundary (FPB) values are expressed in inches.

Bolted Fault Current (kA)	601-800A				801-1200A				1201-1600A				1601-2000A			
	Fuse		LVPCB		Fuse		LVPCB		Fuse		LVPCB		Fuse		LVPCB	
	I.E.	FPB	I.E.	FPB	I.E.	FPB	I.E.	FPB	I.E.	FPB	I.E.	FPB	I.E.	FPB	I.E.	FPB
1	>100	>120	>100	>120	>100	>120	>100	>120	>100	>120	>100	>120	>100	>120	>100	>120
2	>100	>120	>100	>120	>100	>120	>100	>120	>100	>120	>100	>120	>100	>120	>100	>120
3	>100	>120	>100	>120	>100	>120	>100	>120	>100	>120	>100	>120	>100	>120	>100	>120
4	>100	>120	>100	>120	>100	>120	>100	>120	>100	>120	>100	>120	>100	>120	>100	>120
5	>100	>120	>100	>120	>100	>120	>100	>120	>100	>120	>100	>120	>100	>120	>100	>120
6	>100	>120	>100	>120	>100	>120	>100	>120	>100	>120	>100	>120	>100	>120	>100	>120
8	>100	>120	>100	>120	>100	>120	>100	>120	>100	>120	>100	>120	>100	>120	>100	>120
10	75.44	>120	>100	>120	>100	>120	>100	>120	>100	>120	>100	>120	>100	>120	>100	>120
12	49.66	>120	>100	>120	73.59	>120	>100	>120	>100	>120	>100	>120	>100	>120	>100	>120
14	23.87	>120	>100	>120	39.87	>120	>100	>120	>100	>120	>100	>120	>100	>120	>100	>120
16	1.94	25	31.22	>120	11.14	82	>100	>120	24.95	>120	>100	>120	>100	>120	>100	>120
18	1.82	24	35.05	>120	10.76	80	>100	>120	24.57	>120	>100	>120	>100	>120	>100	>120
20	1.70	23	38.87	>120	10.37	78	>100	>120	24.20	>120	>100	>120	>100	>120	>100	>120
22	1.58	22	42.70	>120	9.98	76	>100	>120	23.83	>120	>100	>120	>100	>120	>100	>120
24	1.46	21	46.53	>120	8.88	70	46.53	>120	23.45	>120	>100	>120	29.18	>120	>100	>120
26	1.34	19	50.35	>120	7.52	63	50.35	>120	23.08	>120	>100	>120	28.92	>120	>100	>120
28	1.22	18	54.18	>120	6.28	55	54.18	>120	22.71	>120	>100	>120	28.67	>120	>100	>120
30	1.10	17	58.01	>120	5.16	48	58.01	>120	22.34	>120	>100	>120	28.41	>120	>100	>120
32	0.98	16	61.83	>120	4.15	42	61.83	>120	21.69	>120	61.83	>120	28.15	>120	>100	>120
34	0.86	14	65.66	>120	3.25	35	65.66	>120	18.59	116	65.66	>120	27.90	>120	>100	>120
36	0.74	13	69.49	>120	2.47	29	69.49	>120	15.49	102	69.49	>120	27.64	>120	>100	>120
38	0.62	11	73.31	>120	1.80	24	73.31	>120	12.39	88	73.31	>120	27.38	>120	>100	>120
40	0.50	10	77.14	>120	1.25	18	77.14	>120	9.29	72	77.14	>120	27.13	>120	77.14	>120
42	0.38	8	80.97	>120	0.81	14	80.97	>120	6.19	55	80.97	>120	26.87	>120	80.97	>120
44	0.25	6	84.79	>120	0.49	10	84.79	>120	3.09	34	84.79	>120	26.61	>120	84.79	>120
46	0.25	6	88.62	>120	0.39	8	88.62	>120	2.93	33	88.62	>120	26.36	>120	88.62	>120
48	0.25	6	92.45	>120	0.39	8	92.45	>120	2.93	33	92.45	>120	26.10	>120	92.45	>120
50	0.25	6	96.27	>120	0.39	8	96.27	>120	2.93	33	96.27	>120	25.84	>120	96.27	>120
52	0.25	6	>100	>120	0.39	8	>100	>120	2.93	33	>100	>120	25.59	>120	>100	>120
54	0.25	6	>100	>120	0.39	8	>100	>120	2.93	33	>100	>120	25.33	>120	>100	>120
56	0.25	6	>100	>120	0.39	8	>100	>120	2.93	33	>100	>120	25.07	>120	>100	>120
58	0.25	6	>100	>120	0.39	8	>100	>120	2.93	33	>100	>120	24.81	>120	>100	>120
60	0.25	6	>100	>120	0.39	8	>100	>120	2.93	33	>100	>120	24.56	>120	>100	>120
62	0.25	6	>100	>120	0.39	8	>100	>120	2.93	33	>100	>120	24.30	>120	>100	>120
64	0.25	6	>100	>120	0.39	8	>100	>120	2.93	33	>100	>120	24.04	>120	>100	>120
66	0.25	6	>100	>120	0.39	8	>100	>120	2.92	33	>100	>120	23.75	>120	>100	>120
68	0.25	6	>100	>120	0.39	8	>100	>120	2.80	32	>100	>120	22.71	>120	>100	>120
70	0.25	6	>100	>120	0.39	8	>100	>120	2.67	31	>100	>120	21.68	>120	>100	>120
72	0.25	6	>100	>120	0.39	8	>100	>120	2.54	30	>100	>120	20.64	>120	>100	>120
74	0.25	6	>100	>120	0.39	8	>100	>120	2.42	29	>100	>120	19.61	120	>100	>120
76	0.25	6	>100	>120	0.39	8	>100	>120	2.29	28	>100	>120	18.57	116	>100	>120
78	0.25	6	>100	>120	0.39	8	>100	>120	2.17	27	>100	>120	17.54	111	>100	>120
80	0.25	6	>100	>120	0.39	8	>100	>120	2.04	26	>100	>120	16.50	107	>100	>120
82	0.25	6	>100	>120	0.39	8	>100	>120	1.91	25	>100	>120	15.47	102	>100	>120
84	0.25	6	>100	>120	0.39	8	>100	>120	1.79	24	>100	>120	14.43	97	>100	>120
86	0.25	6	>100	>120	0.39	8	>100	>120	1.66	22	>100	>120	13.39	93	>100	>120
88	0.25	6	>100	>120	0.39	8	>100	>120	1.54	21	>100	>120	12.36	88	>100	>120
90	0.25	6	>100	>120	0.39	8	>100	>120	1.41	20	>100	>120	11.32	83	>100	>120
92	0.25	6	>100	>120	0.39	8	>100	>120	1.28	19	>100	>120	10.29	77	>100	>120
94	0.25	6	>100	>120	0.39	8	>100	>120	1.16	18	>100	>120	9.25	72	>100	>120
96	0.25	6	>100	>120	0.39	8	>100	>120	1.03	16	>100	>120	8.22	66	>100	>120
98	0.25	6	>100	>120	0.39	8	>100	>120	0.90	15	>100	>120	7.18	61	>100	>120
100	0.25	6	>100	>120	0.39	8	>100	>120	0.78	13	>100	>120	6.15	55	>100	>120
102	0.25	6	>100	>120	0.39	8	>100	>120	0.65	12	>100	>120	5.11	48	>100	>120
104	0.25	6	>100	>120	0.39	8	>100	>120	0.53	10	>100	>120	4.08	41	>100	>120
106	0.25	6	>100	>120	0.39	8	>100	>120	0.40	9	>100	>120	3.04	34	>100	>120

Read attached notes. Fuse results are based on actual test data.

Circuit breaker results are based upon IEEE 1584 calculations; if circuit breakers are not properly maintained values can be considerably greater.

www.bussmann.com

For more on Electrical Safety.



Bussmann® LOW-PEAK® Upgrade

The left column represents Bussmann® and competitors' part numbers. The right column represents the Bussmann® LOW-PEAK® upgrades.

CLASS CC and MIDGET	
Existing Fuse	LOW-PEAK® UPGRADE
A6Y type 2B	LP-CC
ABU	
AGU	
ATDR	
ATM	
ATMR	
ATQ	
BAF	
BAN	
BLF	
BLN	
CCMR	
CM	
CMF	
CNM	
CNQ	
CTK	
CTK-R	
FLM	
FLM	
FLQ	
FNM	
FNQ	
FNW	
GGU	
HCLR	
KLK	
KLK-R	
KTK	
KTK-R	
MCL	
MEN	
MEQ	
MOF	
MOL	
OTM	
TRM	
6JX	LP-CC



ATQR	FNQ-R
FNQ-R	FNQ-R
KLDR	FNQ-R

FNQ-R suggested on primary of control transformers

CLASS J	
Existing Fuse	LOW-PEAK® UPGRADE
A4J	LPJ_SP
AJT	
CJ	
CJS	
GF8B	
HRCXXJ	
J	
JA	
JCL	
JDL	
JFL	
JHC	
JKS	
JLS	
JTD	LPJ_SP



The Bussmann® LOW-PEAK® Upgrade offers superior performance while reducing the number of SKU's that need to be in stock. LOW-PEAK® fuses feature a high degree of current limitation, which will provide the best component protection and may reduce the arc-flash hazard. Listings are numerical-alpha by fuse class and fuse catalog symbol. Do you have a part that does not appear in the list? This list is only a consolidated cross-reference to some of our most common products. For a much more extensive database please consult the competitor cross-reference on www.bussmann.com or contact Customer Satisfaction at (636) 527-3877

CLASS R 250V	
Existing Fuse	LOW-PEAK® UPGRADE
A2D	LPN-RK_SP
A2D-R	
A2K	
A2K-R	
A2Y type 1	
AT-DE	
CHG	
CRN-R type 3	
CTN-R	
DEN	
DLN	
DLN-R	
ECN	
ECN-R	
ERN	
FLN	
FLN-R	
FRN	
FRN-R	
FTN-R	
GDN	
HAC-R	
HB	
KLN-R	
KON	
KTN-R	
LENRK	
LKN	
LLN-RK	
LON-RK	
NCLR	
NLN	
NON	
NRN	
OTN	
OTN	
REN	
RFN	
RFN	
RHN	
RLN	
TR	
655	
660	
10KOTN	
50KOTN	LPN-RK_SP



CLASS R 600V	
Existing Fuse	LOW-PEAK® UPGRADE
A6D	LPS-RK_SP
A6K-R	
A6K-R	
A6X type 1	
ATS-DE	
CHR	
CTS-R	
DES	
DES-R	
DLS	
DLS-R	
ECS-R	
ERS	
FLS	
FLS-R	
FRS	
FRS-R	
FTS-R	
GDS	
HA	
KLS-R	
KOS	
KTS-R	
LES	
LES-R	
LES-RK	
LKS	
LLS-RK	
LOS-RK	
NLS	
NOS	
NRS	
OTS	
RES	
RFS	
RHS	
RLS	
SCLR	
TRS	
TRS-R	
656	
10KOTS	
50KOTS	LPS-RK_SP



CLASS L	
Existing Fuses	LOW-PEAK® UPGRADE
A4BQ	KRP-C_SP
A4BT	
A4BY	
A4BY type 55	
CLASS L	
CLF	
CLL	
CLU	
HRC-L	
KLLU	
KLPC	
KLU	
KTU	
L	
LCL	
LCU	KRP-C_SP



The comparative catalog numbers shown were derived from the latest available published information from various manufacturers. Because competitors' products may differ from Bussmann® products, it is recommended that each application be checked for required electrical and mechanical characteristics before substitutions are made. Bussmann® is not responsible for misapplications of our products.

Overcurrent protection is application dependent. Consult latest catalogs and application literature, or contact our Application Engineering Department at (636) 527-1270.

