

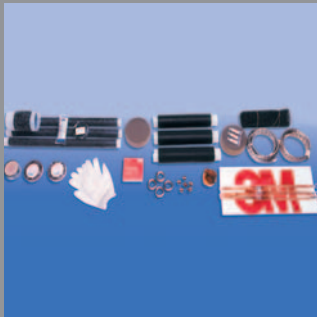

WWW.CABLEJOINTS.CO.UK
THORNE & DERRICK UK
TEL 0044 191 490 1547 FAX 0044 477 5371
TEL 0044 117 977 4647 FAX 0044 977 5582
WWW.THORNEANDDERRICK.CO.UK

**Medium Voltage
Joints &
Terminations**

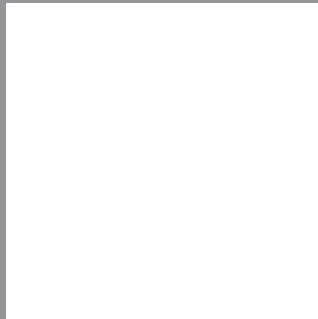

Medium Voltage - Cold Shrink Joints

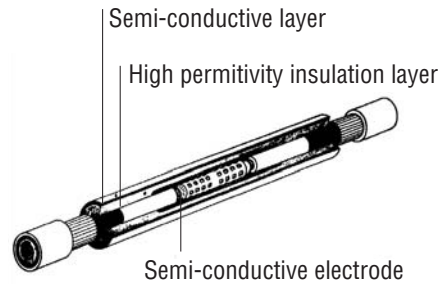
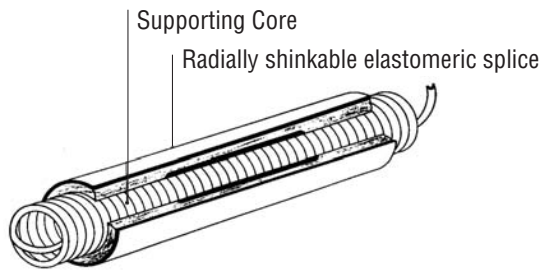

6.6/11/(12) kV

3M QS1000 is a one-piece cold shrink joint body manufactured from a specially formulated silicone material, which provides flexibility, easy installation at low temperatures and superior electrical performance over a wide range of operating temperatures. The finished body is expanded and loaded onto a removable supporting core, which allows the joint to be installed without the need for tools or heat.

3M QS1000 is injection moulded and consists of three layers. A semi-conductive electrode, which forms a Faraday Cage around the connector, a high permittivity insulation layer, which both insulates and stress controls, and an outer semi-conductive layer which ensures all screens are at earth potential.

All finished bodies are tested after manufacture and undergo AC Withstand and Partial Discharge testing.

All joint types have been tested in accordance with VDE 0278, HD 629 and/or BS7888. Details of type tests are available upon request.

Features

- One part joint body
- 100% tested after manufacture
- No heat required
- Tool free installation
- Permanent radial pressure
- Suitable for paper and polymeric cables
- Compatible with compression and mechanical connectors
- Low temperature installation
- Provides consistent installation quality



Medium Voltage - Cold Shrink Joints

3M™ QS1000 Single Core Polymeric Copper Wire Screened

Kit Ref	Application Range CSA (mm ²)	Diameter over Primary Insulation (mm)
92-AG 611-1	70-150	17.7 – 26.0
92-AG 621-1	185-240	22.3 – 33.2
92-AG 631-1	300-400	28.4 – 42.0

3M™ QS1000 TRIF/Transition 3 Core Belted PILC/ PICAS to Three Single Core Polymeric

Kit Ref	Application Range CSA (mm ²)	Diameter over Primary Insulation (mm)
92-FV 611-3	50-95	17.7 – 26.0
92-FV 621-3	120-240	22.3 – 33.2
92-FV 631-3	300-400	28.4 – 42.0

3M™ QS1000 Single Core Polymeric Copper Tape Screened

Kit Ref	Application Range CSA (mm ²)	Diameter over Primary Insulation (mm)
92-AG 612-1	70-150	17.7 – 26.0
92-AG 622-1	185-240	22.3 – 33.2
92-AG 632-1	300-400	28.4 – 42.0

3M™ QS1000 Three Core Polymeric/Paper/Transition, Lead sheath and/or armoured

Application Range CSA (mm ²)	Diameter over Primary Insulation (mm)	Supplementary Kit for Transition Joint	Supplementary Kit for Paper Joint
50-120	17.7 – 26.0	PILCL1	PILCL1 Qty 2
150-185	22.3 – 33.2	PILCL2	PILCL2 Qty 2
300-400	28.4 – 42.0	PILCL3	PILCL3 Qty 2

Medium Voltage - Cold Shrink Joints

Outer Protection Selection for 92-AV series 3 core joints. Choose Cold Shrink EPDM Kit for Polymeric Joints, or a mould and resin combination if required

Joint	Coldshrink Kit	Mould Volume	Resin Standard	#1471 Resin	#1400U Resin Hazardous Area
92-AV 610-3	CS 610-3	1451	14 Litres	10 x 1600g packs	2 x 9060g packs
92-AV 620-3	CS 620-3	1451	14 Litres	10 x 1600g packs	2 x 9060g packs
92-AV-630-3	CS 630-3	1451	21 Litres	14 x 1600g packs	3 x 9060g packs

3M™ Coldshrink Single Core Polymeric Cable Build Up Supplementary Kit

Select in conjunction with any QS1000 Joint kit for polymeric cable, when one or both cables to be joined fall below the minimum range of the joint.

Build Up Kit (Polymeric only)	Range CSA (mm ²)	Insulation Diameter (mm)
92-PG610-1	25 - 50	13.7 - 20.4
92-PG620-1	70 - 150	17.7 - 24.2
92-PG630-1	150 - 240	22.3 - 31.0

Note: These are single phase kits, one is required for each phase to be joined that falls below the minimum range of the joint.

12/20/(24) kV and 19/33/(36) kV

The 3M QS2000 is a one-piece Cold Shrink splice of a multi-layered Silicone rubber body provided in an expanded state. The finished body is loaded onto a removable supporting core, which allows the joint to be installed without the need for tools or heat.

The splice body provides the essential stress relief, re-insulation and semi-conductive screen of power distribution cable systems

- Two inner stress control elements provide the proper electric field distribution.
- The inner semi-conductive electrode electrically surrounds the high voltage connector eliminating the use of tape or additional moulded or metallic electrodes.
- The splice insulation effectively replaces and continues the performance characteristics of the cable insulation across the entire splice.
- The outer semi-conductive layer of the splice adapts to the geometry of the insulation and re-establishes the electromagnetic screen.
- Versatile design of prefabricated one-piece splice body allows installation on a wide range of cable sizes and types.
- Designed to fit all standard cable connectors.
- High contact pressure ensures absolute water tightness.
- Wide temperature range

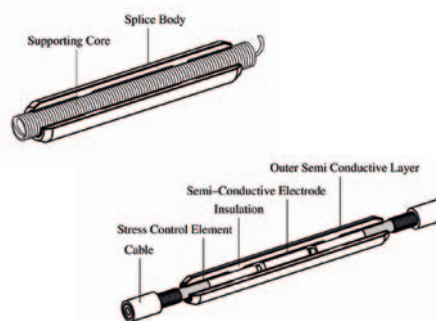

- "Solderless" earth continuity connection.
- Extreme compact size allows installation in narrow areas.
- 100% production tested.
- Cold Shrink technology ensures quick, easy and tool-free installation.

3M™ QS2000 Joint – 3 Core for Polymeric Copper Wire Screened Cable 19/33(36)kV

Kit Ref	Application Range CSA (mm ²)	Diameter over Primary Insulation (mm)
94-AP 230-3	120-300	28.4-42.0 (standard)

3M™ QS2000 Joint – Single Core for Polymeric Copper Wire Screened Cable 12/20(24)kV

Kit Ref	Application Range CSA (mm ²)	Diameter over Primary Insulation (mm)
93-AP 611-1	50-95	17.7-26.0
93-AP 621-1	95-300	22.3-33.2
93-AP 631-1	240-400	28.4-43.0

3M™ QS2000 Joint – Single Core for Polymeric Copper Wire Screened Cable 19/33(36)kV

Kit Ref	Application Range CSA (mm ²)	Diameter over Primary Insulation (mm)
94-AP 631-1	50-400	28.4-42.0 (standard)

Note: Can accommodate smaller cables, with primary insulation from 20.0 - 28.4mm with the use of supplementary build up kit, reference 94-PG620-1. This is a single core kit, 2 must be purchased if both cables to be joined are smaller than 28.4mm over primary insulation diameter.

Medium Voltage - Cold Shrink Joints

6.6/11/(12) kV and 12/20/(24) kV

3M QS2000B Branch Splice Body – developed from the QS2000 Inline Splice

- One-part splice body for a wide application range
- Tool-free installation
- Symmetrical cutback dimensions including the branch cable
- Supplied complete with mechanical branch connectors
- 100% tested at point of manufacture
- Compact design for installations in narrow areas

- Excellent performance and reliability developed from the QS2000 inline splice
- Constructed from high-performance LSR - silicone
- Excellent shrinkage at low temperatures
- Permanent radial pressure on the cable
- Outstanding dielectric properties
- Very high thermal stability and long-term elasticity
- Excellent mechanical properties

3M™ QS2000B Single Core Branch –XLPE/Copper Wire Screened, Connectors included For 6.6/11 (12)kV and 12/20(24)kV Applications

Kit Ref	Application Range CSA (mm ²)	Diameter over Primary Insulation (mm)
93-BP 620-1	95-240	22.3 – 33.2

19/33/(36)kV

The 3M QSIII Splice Body revolutionised power cable jointing. The QS-III silicone rubber joint meets the customer demands for easy, consistent installations by eliminating the pushing, pulling or heating required by traditional splices. The Cold Shrink QS-III joint features a silicone rubber body, which provides excellent electrical properties and superior low temperature handling. Plus the QS-III meets the requirements of most world-wide standards including IEEE 404 and European VDE 278.

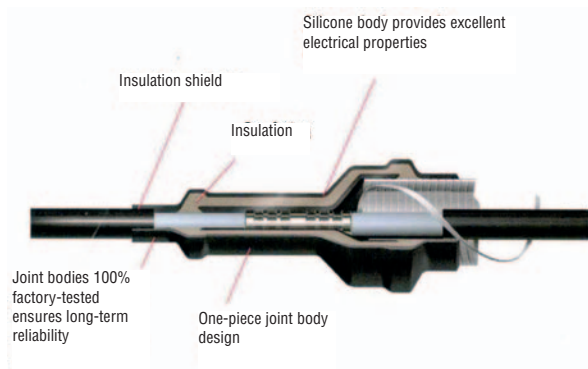

- No heat, flames or special installation tools required.
- Minimal training required.
- Easy, fast installation.
- Symmetrical cable cutback dimensions.
- Allows transitioning of different size cables.
- Silicone body provides excellent electrical performance and superior low temperature handling.
- Joint bodies are 100% factory tested.
- One-piece joint body design.
- Field proven technology.
- Meets IEEE 404 and European VDE and CENELEC/IEC standards.
- Wide Cable range for individual joint bodies.

3M™ QSIII Joint – Single Core for Polymeric Copper Wire Screened Cable

Kit Ref	Application Range CSA (mm ²)	Diameter over Primary Insulation (mm)
94-AC640-1	300-630	36.4-53.3

3M™ QSIII Joint – Single Core for Polymeric Lead Sheath Armoured Cable

Kit Ref	Application Range CSA (mm ²)	Diameter over Primary Insulation (mm)
94-AC642-1	300-630	31.5-52.6

25/46(52)kV

3M™ QSIII Joint - Single Core for Polymeric Copper Wire Screened Cable

Kit Ref	Application Range CSA (mm ²)	Diameter over Primary Insulation (mm)
95-AC643-1	120-630	33.5-53.8

Medium Voltage - Cold Shrink Terminations

QTIII terminations offer easy installation and reliable performance when terminating indoor and outdoor medium voltage cables. QTIII is a one-piece silicone rubber termination, which is expanded and loaded onto a removable supporting core, which allows the termination to be installed without the need for tools or heat. The core is stepped to allow a greater application range for armoured cables. QTIII consists of a tubular silicone insulator, with a built in refractive stress control tube and compound, and a built in top seal. Due to this unique design the QTIII termination is installed in one operation without the need for any additional components.

QTIII terminations are suitable for use on polymeric cables medium voltage up to 52kV.

Both indoor and outdoor terminations are available for single core and three core cables. QTIII terminations have been tested in accordance with IEEE Std 48-1990, VDE 0278 Part 4 and IEC/CENELEC. Details of type tests are available upon request.

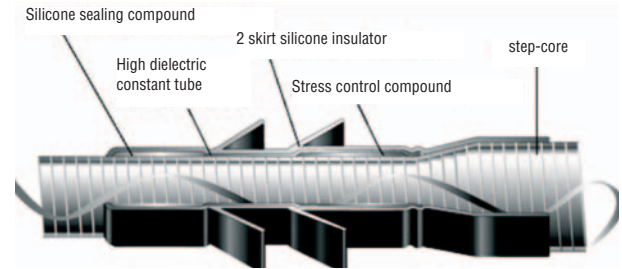

Outdoor Termination



Indoor Termination

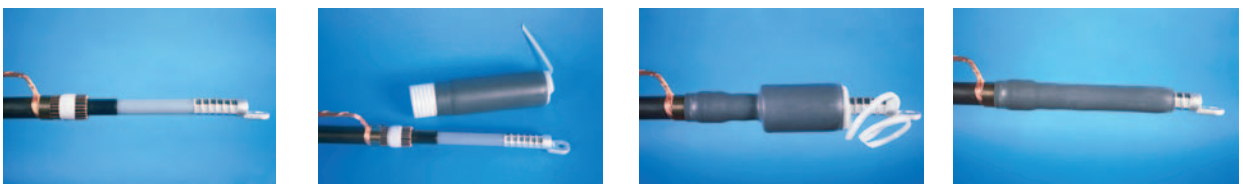

Medium Voltage - Cold Shrink Terminations

QTIII terminations are manufactured from silicone rubber, which has been specially formulated to enhance the properties required for MV terminations.

Advantages of 3M Silicone as an insulator are:

- Excellent insulating properties.
- Hydrophobic properties
- Hydrophobic recovery
- UV stable
- Non-flammable
- Fungus resistant
- Excellent high and low temperature properties
- Superior track and erosion resistance

QTIII Features

- One-piece termination
- Built in stress control compound
- Built in top seal
- Moulded rain sheds on outdoor terminations
- Optimum High-K stress control
- Compact design
- High reliability, over 20 years of proven field experience
- Continuous operating temperature of 90°C, overload rating 130°C



6.6/11/(12) kV

3M™ QTIII Indoor Single Core Polymeric Copper Tape Screened, Lead Sheath and/or Aluminium wire Armoured.

Kit Ref	Application Range CSA (mm ²)	Diameter over Primary Insulation (mm)
92-EP623-1	50-95	16.3-27.4
92-EP633-1	120-150	20.5-38.9
92-EP643-1	185-400	20.5-38.9
92-EP653-1	500-630	26.7-45.7

3M™ QTIII Outdoor Single Core Polymeric Copper Tape Screened, Lead Sheath and/or Aluminium wire Armoured.

Kit Ref	Application Range CSA (mm ²)	Diameter over Primary Insulation (mm)
92-EP623-2	50-95	16.3-27.4
92-EP633-2	120-150	20.5-38.9
92-EP643-2	185-400	20.5-38.9
92-EP653-2	500-630	26.7-45.7

3M™ QTIII Three Core Polymeric Copper Tape Screened / Armoured

Kit Ref	Application Range CSA (mm ²)	Diameter over Primary Insulation (mm)
7621-T95-3W	16-50	12.7-17.8
7623-T95-3W	70-120	17.8-23.4
7624-T95-3W	150-300	23.4-30.0

Outdoor

Kit Ref	Application Range CSA (mm ²)	Diameter over Primary Insulation (mm)
7691-S4-3W	16-50	12.7-17.8
7692-S4-3W	70-120	17.8-23.4
7693-S4-3W	150-300	23.4-30.0

Medium Voltage - Cold Shrink Terminations

6.6/11/(12) kV

3M™ QTIII Indoor 11kV Single Core Polymeric Copper Wire Screened

Kit Ref	Application Range CSA (mm2)	Diameter over Primary Insulation (mm)
92-EP621-1	50-95	16.3-27.4
92-EP631-1	120-400	20.5-38.9
92-EP641-1	500-630	26.7-45.7
92-EP656-1	630-1000	35.9-55.9

3M™ QTIII Outdoor 11kV Single Core Polymeric Copper Wire Screened

Kit Ref	Application Range CSA (mm2)	Diameter over Primary Insulation (mm)
92-EP621-2	50-95	16.3-27.4
92-EP631-2	120-400	20.5-38.9
92-EP641-2	500-630	26.7-45.7

3M™ 11kV Three Core Termination for Belted PILC / PICAS Cables (Paper Insulated Lead Covered/Paper Insulation Corrugated Aluminium Sheath)

- Inorganic cold shrink silicone insulation
- Coldshrink EPDM moisture sealing tubes
- Track resistant surface
- Moulded rain sheds for outdoor version
- No tools, easy install, ultra lightweight assembly
- Cold pour 2130 resin to fill and insulate crotch area

Kit Ref	Application Range CSA (mm2)	Diameter over Primary Insulation (mm)
MT16	70-300	Indoor
MO16	70-300	Outdoor

12/20/(24) kV

3M™ QTIII Indoor Single Core Terminations - Polymeric / Copper Wire Screened / Non Armoured

Kit Ref	Application Range CSA (mm2)	Diameter over Primary Insulation (mm)
93-EP610-1	25-120	16.3-27.4
93-EP620-1	95-240	21.1-38.9

3M™ QTIII Outdoor Single Core Terminations - Polymeric / Copper Wire Screened / Non Armoured

Kit Ref	Application Range CSA (mm2)	Diameter over Primary Insulation (mm)
92-EP621-2	50-95	16.3-27.4
92-EP631-2	120-400	20.5-38.9
92-EP641-2	500-630	26.7-45.7

19/33/(36) kV

3M™ QTIII Indoor / Outdoor 33kV Single Core Polymeric / Copper Wire Screened

Kit Ref	Application Range CSA (mm2)	Diameter over Primary Insulation (mm)
94-EP610-2	35-120	18.3-32.8
94-EP620-2	50-150	21.1-38.9
94-EP630-2	120-300	26.7-45.7
94-EP640-2	240-630	38.9-58.9

3M™ QTIII Indoor / Outdoor 33kV Single Core Polymeric / Copper Tape Screened / Aluminium Wire Armoured

Kit Ref	Application Range CSA (mm2)	Diameter over Primary Insulation (mm)
94-EP612-2	50-120	18.3-32.8
94-EP622-2	70-240	21.1-38.9
94-EP632-2	185-400	26.7-45.7
94-EP642-2	400-630	38.9-58.9

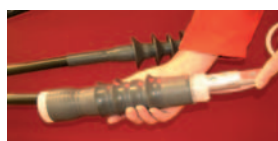

25/46/(52) kV

3M™ QTIII Indoor/Outdoor Single Core Polymeric/Copper Wire Screened

Kit Ref	Application Range CSA (mm2)	Diameter over Primary Insulation (mm)
95-EP 631-2	240-500	38.6-51.0

3M™ QTII Indoor/Outdoor Termination Single Core Polymeric Copper Wire Screened

Kit Ref	Application Range CSA (mm2)	Diameter over Primary Insulation (mm)
95-EB 62-2	70-400	33-53
95-EB 63-2	400-1000	46-66