

HEATSHRINKABLE CABLE ACCESSORIES FOR
MAINTENANCE AND NEW WORKS INSTALLATIONS OF

RAILWAY

SIGNAL • TELECOM • ELECTRIFICATION

CABLE NETWORKS



THORNE & DERRICK UK



Contents

Page 1	Gas Torch Kits for use with Heatshrink materials
Page 2	Track Circuit Rail Connection Components
Page 3	Track Circuit Rail Connection Kits
Page 4	Track Circuit Cable Joint Kits
Page 5	Duplicated Track Circuit Cable Joint Kits
Page 6	Yellow Bonding Kits and T.P.W.S Joint and Termination Kits
Page 7	Flexible Tail Cable and Data Link Cable Joint Kits
Page 8	Lineside Multicore Signalling Cable Joint Kits
Page 9	Power Cable Joint Kits 0.6/1kV
Page 10	Heatshrink Wrap Sleeves, Moisture Barrier Kits and End Caps
Page 11	Telecom Joint Kits
Page 12	CCTV Coaxial and Sundry Telecom Cable Joint Kits
Page 13	Heatshrink Thin and Thick Wall Tube
Page 14	Heatshrinkable Cable Glands - Introduction
Page 15	Heatshrinkable Cable Glands - Dimensional Detail
Page 16	Heatshrinkable Cable Glands - Applications Table
Page 17	Heatshrink Joint Kits for Low Smoke Fume (ZHLS) Cables
Page 18	Additional Products
Page 19	P.A.D.S Cat. No. / Part No. / Page No. Cross Reference List



Thorne & Derrick UK

Bristol Head Office

Tel: 0117 977 4647

Fax: 0117 977 5582

Northern Office

Tel: 0191 490 1547

Fax: 0191 477 5371

GAS TORCH KITS

Two Gas Torch kits SPS 201 and SPS 202 have been specially developed for use in the Railway environment. They are designed to provide the most efficient Hot air or Flame type heat sources for use with Heatshrink kits indoors or outdoors.

SPS 201 : PADS CAT NO: 54/37088

This gas Torch is featured in the Tool Handbook for Signalling Technicians and is also part of the Track Bonding Tool Kit No: 3 P.A.D.S CAT NO: 86/3023.

It delivers a powerful stream of hot air and its easy to carry design makes it ideal for use by maintenance teams using Primus 2000 Gas Cylinders.

SPS 201 features fail safe automatic ignition and the special Brass Adaptor supplied with the kit allows the Torch to be converted for use on standard LPG Propane Cylinder outlet valves.



AUTO IGNITE
HANDLE



HOSE AND
FITTINGS



PRIMUS 2000
CYLINDER



SPS 863: PADS CAT. NO: 54/31016

This is a replacement Hose for kit reference number SPS 201: P.A.D.S CAT. NO: 54/37088

SPS 202: PADS CAT. NO: 40/17801

This gas Torch delivers an ideal soft flame suitable for use with Heatshrinkable material. It is designed for use with standard LPG Propane Cylinder Outlet Valves.

Note: The Torch Head is manually lit and does not feature the Auto Ignite Handle.





Thorne & Derrick UK

Bristol Head Office

Tel: 0117 977 4647

Fax: 0117 977 5582

Northern Office

Tel: 0191 490 1547

Fax: 0191 477 5371

TRACK CIRCUIT RAIL CONNECTION COMPONENTS

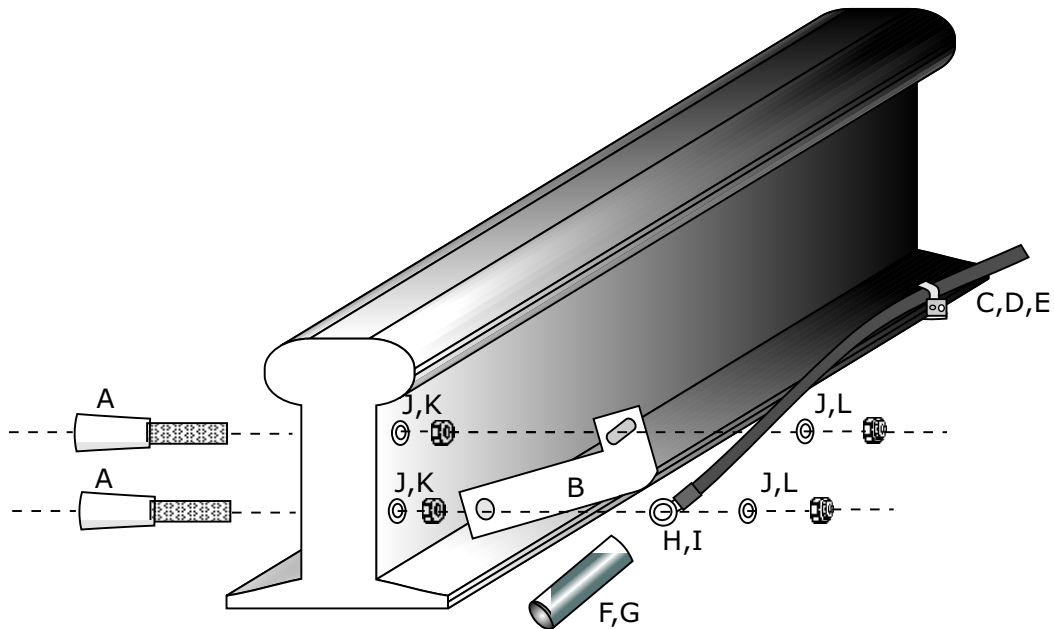

GUIDE TO TRACK CIRCUIT RAIL CONNECTION KIT COMPONENTS

LETTER CODE	PART NUMBER	P.A.D.S CAT. NO	COMPONENTS
A	SPS 696	86/44013	STAINLESS STEEL TAPER PIN
B	SPS 697	86/43488	STAINLESS STEEL "L" BRACKET
C	SPS 115	86/43489	FLANGE CLIP WITH 12mm CABLE CLEAT
D	SPS 116	86/43498	FLANGE CLIP WITH 15mm CABLE CLEAT
E	SPS 117	86/43499	FLANGE CLIP WITH 25mm CABLE CLEAT
F	TMI 22/6/55	55/120989	HEATSHRINK SUPPORT SLEEVE 2.5mm ² CABLE
G	TMI 30/8/55	54/158116	HEATSHRINK SUPPORT SLEEVE 35mm ² CABLE
H	AMP 324063	54/119568	2.5mm ² CRIMP RING TERMINAL (BLACK)
I	T35-6	54/119492	35mm ² CRIMP TERMINAL
J	A2 SS M6 FMA WASHER	3/190825	STAINLESS STEEL A2 M6 FMA WASHER
K	A2 SS M6 FULL NUT	3/175013	STAINLESS STEEL A2 M6 FULL NUT
L	A2 SS SELF LOCK NUT	3/179995	STAINLESS STEEL A2 SELF LOCK NUT

Table 1



Thorne & Derrick UK

Bristol Head Office

Tel: 0117 977 4647

Fax: 0117 977 5582

Northern Office

Tel: 0191 490 1547

Fax: 0191 477 5371

STAINLESS STEEL TRACK CIRCUIT RAIL CONNECTION KITS

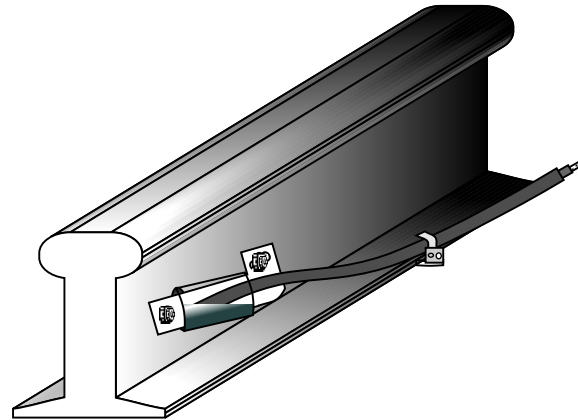

SINGLE CORE 2.5mm² TC
CABLE 6/120130

PART NUMBER	P.A.D.S CAT. NO	KIT CONTENTS (SEE TABLE 1)	APPLICATION
SPS 695	86/44019	2A, 1B, 1C, 1F, 1H, 4J, 2K, 2L	COMPLETE TRACK CIRCUIT RAIL CONNECTION KIT FOR 1 CORE 2.5mm ² (6/120130)
SPS 699	86/44021	2A, 1B, 1D, 1G, 1I, 4J, 2K, 2L	TRACK CIRCUIT RAIL CONNECTION KIT FOR JOINTLESS ASTER OR T1 21 1 CORE 35mm ²

MOULDED LEAD TRACK CIRCUIT RAIL FIXINGS

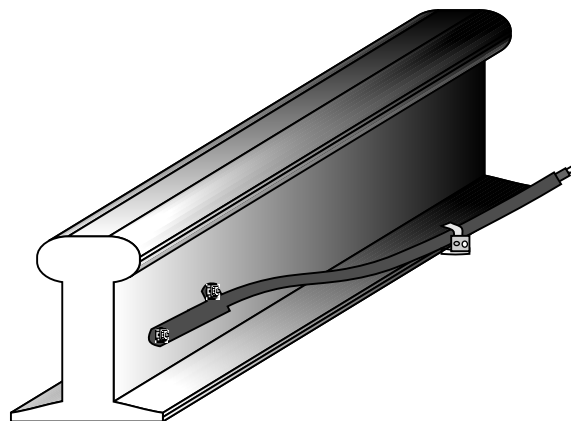

PART NUMBER	P.A.D.S CAT. NO	KIT CONTENTS (SEE TABLE 1)	APPLICATION
SPS 698	86/10037	10A, 10K, 20J, 10L	TRACK CIRCUIT MAINTENANCE KIT (5 FIXINGS PER KIT)
SPS 700	86/44017	2A, 1C, 2K, 4J, 2L	STAINLESS STEEL FIXING KIT FOR ALL TYPES OF MOULDED TRACK CIRCUIT RAIL CONNECTION KITS



Thorne & Derrick UK

Bristol Head Office

Tel: 0117 977 4647

Fax: 0117 977 5582





Northern Office

Tel: 0191 490 1547

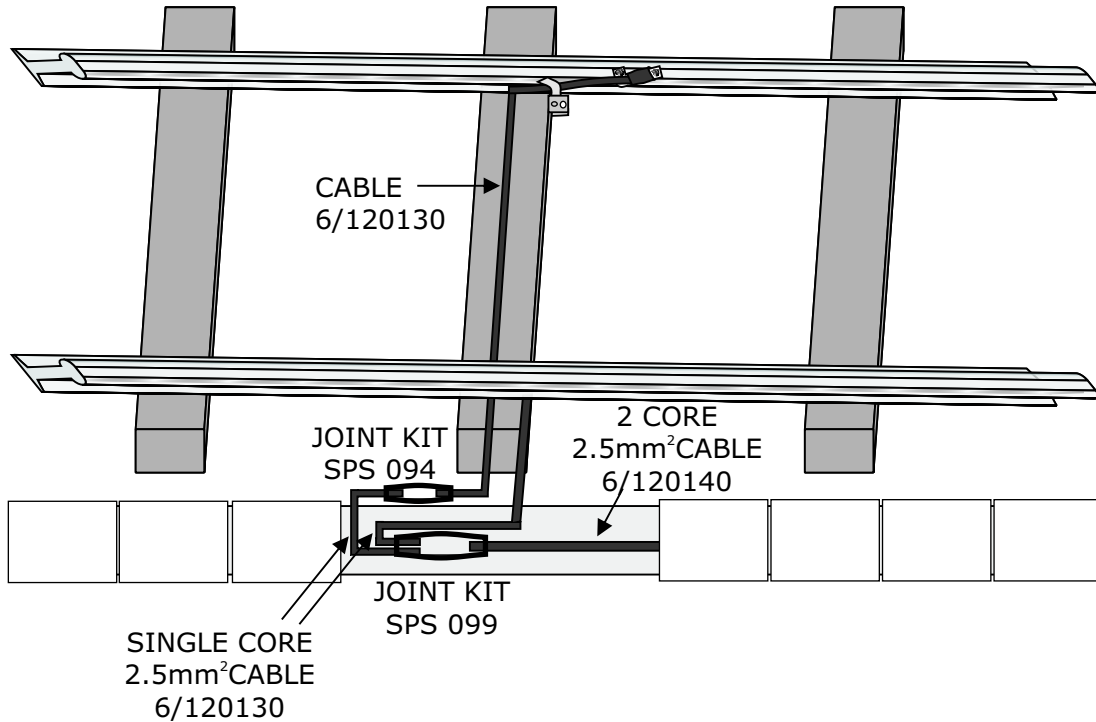
Fax: 0191 477 5371

**TRACK CIRCUIT CABLE JOINT KITS
ALL KITS COMPLETE WITH CRIMP CONNECTORS**



PART NUMBER	P.A.D.S CAT. NO	JOINT DESCRIPTION	JOINT STYLE
SPS 094	54/15875	JOINT KIT FOR SINGLE CORE 2.5mm ² TC CABLE (10 JOINTS PER KIT)	1 x 6/120130 1 x 6/120130 
SPS 095	54/37005	JOINT KIT FOR SINGLE CORE 10mm ² TC CABLE (10 JOINTS PER KIT)	1 x 6/120062 1 x 6/120062 
SPS 099	54/15289	JOINT KIT FOR 2 x SINGLE CORE 2.5mm ² TC CABLE TO 1 x 2 CORE 2.5mm ²	2 x 6/120130 1 x 6/120140 
SPS 100	54/15873	JOINT KIT FOR 2 x SINGLE CORE 10mm ² TC CABLE TO 1 x 2 CORE 2.5mm ²	2 x 6/120062 1 x 6/120140 



Thorne & Derrick UK

Bristol Head Office

Tel: 0117 977 4647

Fax: 0117 977 5582

Northern Office

Tel: 0191 490 1547



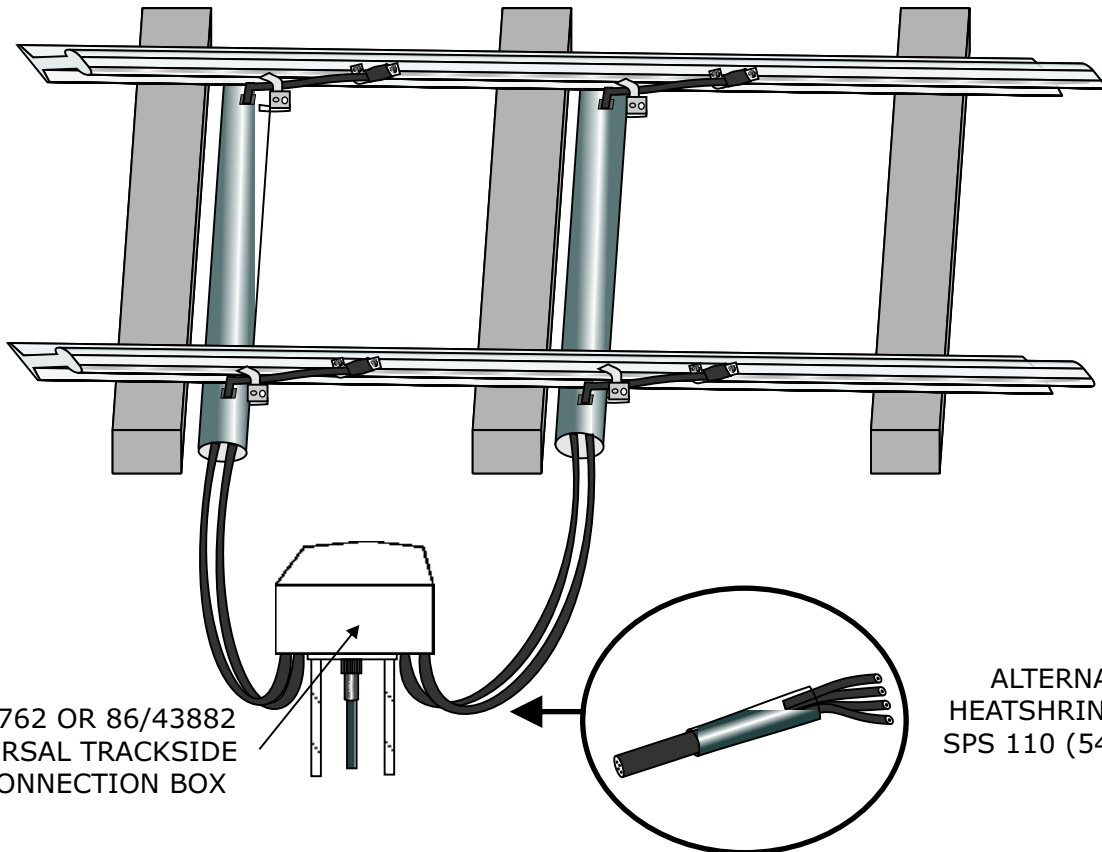

Fax: 0191 477 5371

DUPLICATED TRACK CIRCUIT CABLE JOINT KITS
ALL KITS COMPLETE WITH CRIMP CONNECTORS

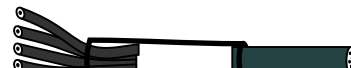

86/10762 OR 86/43882
 UNIVERSAL TRACKSIDE
 DISCONNECTION BOX

ALTERNATIVE
 HEATSHRINK JOINT
 SPS 110 (54/36102)

PART NUMBER	P.A.D.S CAT. NO	JOINT DESCRIPTION	JOINT STYLE
SPS 109	54/36101	JOINT KIT FOR SINGLE CORE 2.5mm ² TC CABLE TO 1 x SINGLE CORE 2.5mm ² CABLE	2 x 6/120130 1 x 6/120130 
SPS 110	54/36102	JOINT KIT FOR 4 x SINGLE CORE 2.5mm ² TC CABLE TO 1 x 2 CORE 2.5mm ²	4 x 6/120130 1 x 6/120140 
SPS 111	54/36103	JOINT KIT FOR 4 x SINGLE CORE 2.5mm ² TC CABLE TO 1 x 4 CORE 2.5mm ²	4 x 6/120130 1 x 6/120141 
SPS 114	54/36106	JOINT KIT FOR 2 x 2 CORE 2.5mm ² TC CABLE TO 1 x 4 CORE 2.5mm ²	2 x 6/120140 1 x 6/120141 



Thorne & Derrick UK

Bristol Head Office

Tel: 0117 977 4647

Fax: 0117 977 5582

Northern Office

Tel: 0191 490 1547

Fax: 0191 477 5371

YELLOW BONDING KITS

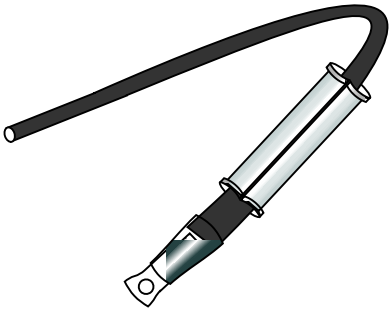
PART NUMBER	P.A.D.S CAT. NO	JOINT DESCRIPTION	JOINT STYLE
SPS 702	54/37092	JOINT KIT FOR SINGLE CORE 35mm ² TYPE B1 YELLOW BONDING CABLE	6/120063 
SPS 983	54/64087	15mm I/D EASY FIT YELLOW BONDING CABLE IDENTIFICATION SLEEVE (5 PER PACK)	
SPS 984	54/64088	25mm I/D EASY FIT YELLOW BONDING CABLE IDENTIFICATION SLEEVE (5 PER PACK)	
SPS 985	54/64089	35mm I/D EASY FIT YELLOW BONDING CABLE IDENTIFICATION SLEEVE (5 PER PACK)	

T.P.W.S - TRAIN PROTECTION WARNING SYSTEM KITS

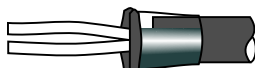

PART NUMBER	P.A.D.S CAT. NO	JOINT DESCRIPTION	JOINT STYLE
SPS 970	54/37093	JOINT KIT FOR 2 CORE 2.5mm ² SCREENED TWISTED PAIR CABLE (TYPE 6/160086)	1 x 6/160086 1 x 6/160086 
SPS 980	54/37094	MOISTURE BARRIER KIT SEALING END OF CABLE TYPE 6/160086	



Thorne & Derrick UK

Bristol Head Office

Tel: 0117 977 4647

Fax: 0117 977 5582

Northern Office

Tel: 0191 490 1547

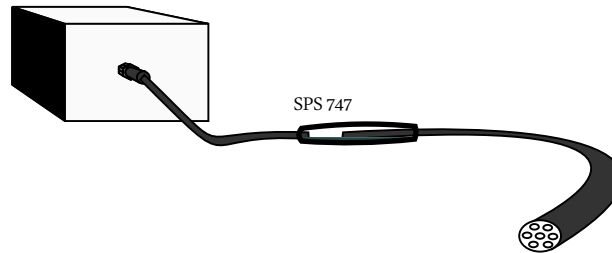

Fax: 0191 477 5371

**FLEXIBLE TAIL CABLE JOINT KITS
ALL KITS COMPLETE WITH CRIMP CONNECTORS**



PART NUMBER	P.A.D.S CAT. NO	JOINT DESCRIPTION	CABLE TYPES	
SPS 111	54/36103	JOINT KIT FOR 4 CORE 2.5mm ² TYPE C2 TAIL CABLE	1x6/120141	1x6/12041
SPS 747	54/37125	JOINT KIT FOR 7-16 CORE 2.5mm ² TYPE C2 TAIL CABLE	1x6/120142 1x6/120143 1x6/120144 1x6/120145	1x6/120142 1x6/120143 1x6/120144 1x6/120145
SPS 944	54/37114	JOINT KIT FOR 2 CORE 1.5mm ² POINT HEATER CABLE	1x6/120081	1x6/120081

**DATA - LINK CABLE JOINT KITS
SCREENED AND UNSCREENED**

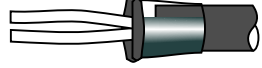
PART NUMBER	P.A.D.S CAT. NO	JOINT DESCRIPTION	JOINT STYLE	
SPS 107	54/37079	JOINT KIT FOR UNSCREENED 2 CORE 1.5mm ² DATA-LINK CABLE	1x6/166065	1x6/166065 
SPS 108	54/15877	JOINT KIT FOR 2 CORE 1.5mm ² WITH ADDITIONAL SCREENING CORE	1x6/167020	1x6/167020 
SPS 720	54/37070	MOISTURE BARRIER KIT FOR SCREENED OR UN- SCREENED DATA-LINK CABLE		



Thorne & Derrick UK

Bristol Head Office

Tel: 0117 977 4647

Fax: 0117 977 5582

Northern Office

Tel: 0191 490 1547

Fax: 0191 477 5371

**LINESIDE MULTICORE SIGNALLING CABLE JOINT KITS
ALL KITS COMPLETE WITH CRIMP CONNECTORS**

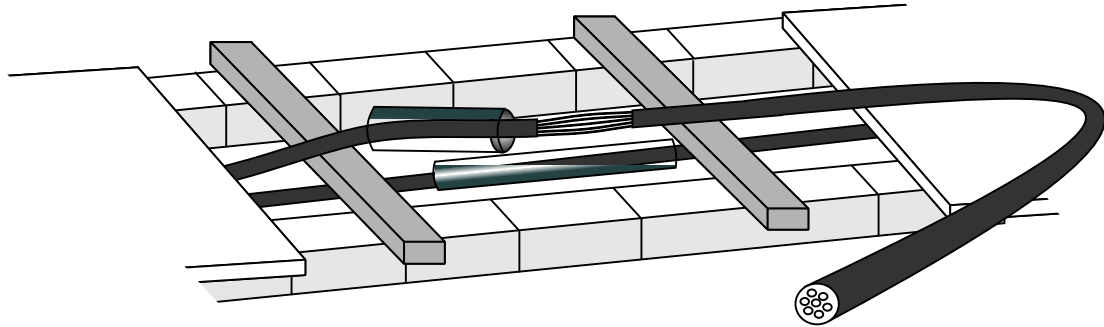

PART NUMBER	P.A.D.S CAT. NO	JOINT DESCRIPTION SIZE (mm ²)	CABLE P.A.D.S CAT. NO
SPS 071	54/15870	7 CORE 1.5 JOINT	6/120091
SPS 071	54/15870	10 CORE 0.75-1.5 JOINT	6/120093 AND 6/120094
SPS 071	54/15870	12 CORE 0.75-1.5 JOINT	6/120096 AND 6/120097
SPS 072	54/15871	19 CORE 0.75-1.5 JOINT	6/120099 AND 6/120100
SPS 073	54/15874	27 CORE 0.75-1.5 JOINT	6/120102 AND 6/120103
SPS 074	54/15872	37 CORE 0.75-1.5 JOINT	6/120105 AND 6/120106
SPS 075	54/37009	48 CORE 0.75-1.5 JOINT	6/120108 AND 6/120109
SPS 076	54/15880	61 CORE 0.75-1.5 JOINT	
SPS 703	54/37120	7 CORE 2.5 JOINT	6/120092
SPS 703	54/37120	10 CORE 2.5 JOINT	6/120095
SPS 703	54/37120	12 CORE 2.5 JOINT	6/120098
SPS 704	54/37121	19 CORE 2.5 JOINT	6/120101
SPS 705	54/37122	27 CORE 2.5 JOINT	6/120104
SPS 706	54/37123	37 CORE 2.5 JOINT	6/120107
SPS 707	54/37124	48 CORE 2.5 JOINT	6/120110

**LINESIDE MULTICORE SIGNALLING CABLE JOINT KITS
FOR NON STANDARD APPLICATIONS**

WRAPAROUND TEST
POINT REPAIR SPS
848/718/719

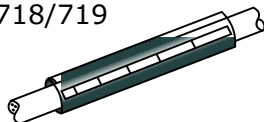

LOOP JOINT
SPS 134

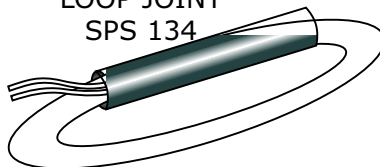

TRANSITION JOINT
SPS 709/710

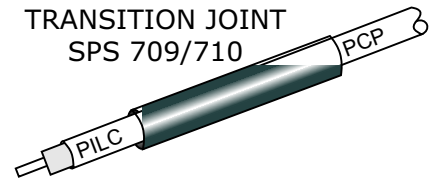

PART NUMBER	P.A.D.S CAT. NO	CABLE SIZE (mm ²)	JOINT DESCRIPTION
SPS 848	---	7-10 CORE 0.75-2.5	TEST POINT KITS FOR SIGNALLING CABLE
SPS 718	54/37078	12-27 CORE 0.75-2.5	TEST POINT KITS FOR SIGNALLING CABLE
SPS 719	54/37077	37-48 CORE 0.75-2.5	TEST POINT KITS FOR SIGNALLING CABLE
SPS 134	54/15889	37 CORE 0.75-1.5	INDUCTION LOOP JOINT (REED T/C)
SPS 709	54/15846	37 CORE 0.75-1.5	TRANSITION JOINT TYPE B2 TO PILC
SPS 710	54/15848	19 CORE 0.75-1.5	TRANSITION JOINT TYPE B2 TO PILC



Thorne & Derrick UK

Bristol Head Office

Tel: 0117 977 4647

Fax: 0117 977 5582



Northern Office

Tel: 0191 490 1547

Fax: 0191 477 5371

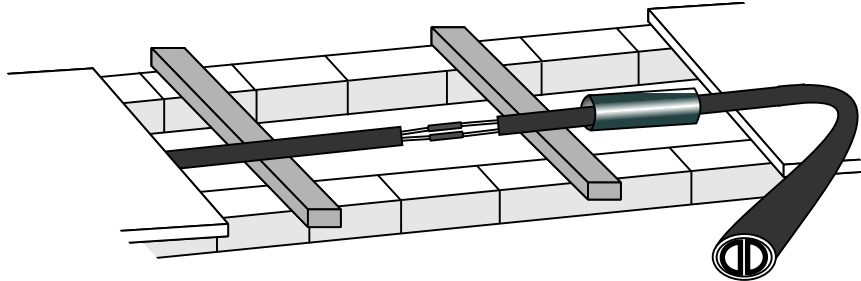
POWER CABLE JOINT KITS FOR STRANDED COPPER AND SOLID SECTORAL ALUMINIUM CONDUCTORS 0.6/1kV

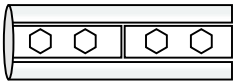

PART NUMBER	P.A.D.S CAT. NO	JOINT DESCRIPTION	CABLE P.A.D.S CAT. NO INC. ALUMINIUM CONNECTORS
SPS 711	54/37095	2 CORE 16mm ² TYPE BR880 CABLE	---
SPS 712	54/37096	2 CORE 25mm ² TYPE BR880 CABLE	6/142519
SPS 713	54/37097	2 CORE 35mm ² TYPE BR880 CABLE	6/142609
SPS 714	54/37098	2 CORE 50mm ² TYPE BR880 CABLE	6/142629
SPS 715	54/37099	2 CORE 70mm ² TYPE BR880 CABLE	6/142639
SPS 716	54/37100	2 CORE 95mm ² TYPE BR880 CABLE	6/142644
SPS 1013	APPLIED FOR	JOINT COMPLETE WITH MECHANICAL CONNECTORS TO SUIT 16-95mm ² 2 CORE SOLID AL POWER CABLE	
SPS 832 SPS 975	54/37101 54/37102	4 CORE 70mm ² TYPE BR880 CABLE 4 CORE 95mm ² TYPE BR880 CABLE	6/151469 6/151494 

PART NUMBER	P.A.D.S CAT. NO	JOINT DESCRIPTION	CABLE P.A.D.S CAT. NO INCLUDES COPPER CONNECTORS
SPS 101	54/37012	2 CORE 1.5-2.5mm ² TYPE B2 CABLE	6/120081 & 6/120082
SPS 102	54/15857	2 CORE 10mm ² TYPE B2 CABLE	6/120083
SPS 103	54/15891	2 CORE 35mm ² TYPE B2 CABLE	6/120084
SPS 104	54/15892	2 CORE 50mm ² TYPE B2 CABLE	---
SPS 105	54/15878	2 CORE 70mm ² TYPE B2 CABLE	6/120085
SPS 106	54/15879	2 CORE 95mm ² TYPE B2 CABLE	6/120086x
SPS 717	54/37074	TRANSITION 2 CORE 35mm ² TYPE B2 TO 35mm ² PILC	---
SPS 748	54/37090	4 CORE 10mm ² TYPE B2 CABLE	---

PART NUMBER	P.A.D.S CAT. NO	JOINT DESCRIPTION	CABLE P.A.D.S CAT. NO CONNECTORS NOT INCLUDED
SPS 079	54/15759	2 CORE 10-35mm ² TYPE B2 CABLE	6/120083
SPS 080	54/15886	2 CORE 70-95mm ² TYPE B2 CABLE	6/120084
SPS 081	54/36100	4 CORE 70-95mm ² TYPE B2 CABLE	6/120085

PART NUMBER	P.A.D.S CAT. NO	JOINT DESCRIPTION	CABLE P.A.D.S CAT. NO CONNECTORS NOT INCLUDED
SPS 916	54/37115	2 CORE 10-35mm ² CABLE END TERMINATING KIT	6/120083 & 6/120084



Thorne & Derrick UK

Bristol Head Office

Tel: 0117 977 4647

Fax: 0117 977 5582

Northern Office

Tel: 0191 490 1547

Fax: 0191 477 5371

**HEATSHRINK WRAPAROUND CABLE SHEATH REPAIR
SUITABLE FOR POWER, SIGNALLING AND TELECOM CABLES**

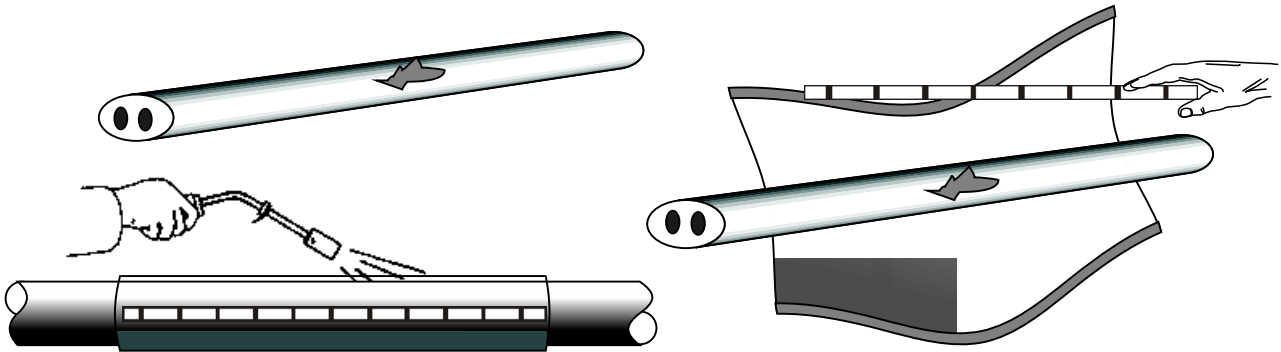

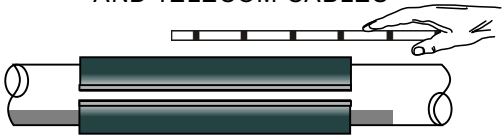
PART NUMBER	P.A.D.S CAT. NO	RECOMMENDED WORKING RANGE	JOINT STYLE
SWRS 50-15-1000	54/18640	13mm TO 40mm	ALL TYPES OF POWER, SIGNALLING AND TELECOM CABLES 
SWRS 75-22-1000	54/18606	20mm TO 60mm	
SWRS 105-30-1000	54/18608	28mm TO 90mm	
SWRS 146-38-1000	54/18609	35mm TO 130mm	
SWRS 188-55-1000	54/18607	50mm TO 175mm	

MOISTURE BARRIER KITS

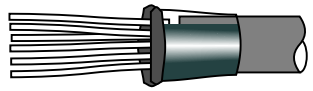
PART NUMBER	P.A.D.S CAT. NO	JOINT DESCRIPTION TO SUIT CABLE DIA	JOINT STYLE
SPS 077	54/13658	CABLE GLAND SUPPORT AND SEALING COLLAR (10 PER KIT)	ALL TYPES OF POWER AND SIGNALLING CABLE 
SPS 980	54/37094	TPWS CABLE (24 PER KIT)	
SPS 720	54/37070	6mm TO 14mm (24 PER KIT)	
SPS 096	54/37052	13mm TO 24mm (24 PER KIT)	
SPS 097	54/37053	20mm TO 37mm (24 PER KIT)	
SPS 098	54/37054	27mm TO 48mm (24 PER KIT)	

CABLE END SEALING CAPS

PART NUMBER	P.A.D.S CAT. NO	RECOMMENDED WORKING RANGE	JOINT STYLE
C12-4	54/10716	4mm TO 10mm	CABLE SEALING CAP 
C20-8	54/12054	9mm TO 18mm	
C40-15	54/12051	15mm TO 35mm	
C63-25	54/12052	25mm TO 60mm	
C76-30	54/12053	30mm TO 72mm	



Thorne & Derrick UK

Bristol Head Office

Tel: 0117 977 4647

Fax: 0117 977 5582

Northern Office

Tel: 0191 490 1547

Fax: 0191 477 5371

**COMPOUND FILLED UNIT TWIN COPPER
TELECOM JOINT ENCLOSURES
CABLE SPECIFICATION RT/E/PS/00015**

SPS Telecom Jointing kits comprise a range of Heatshrinkable Enclosures in Tubular and Wraparound form. The system accommodates Single and Multi-Cable entry and each Enclosure allows re-entry if required.

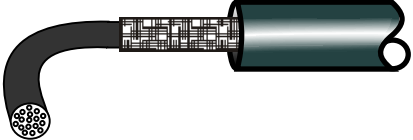
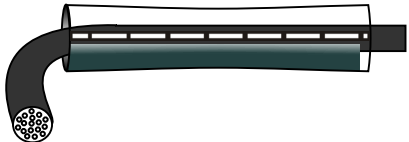
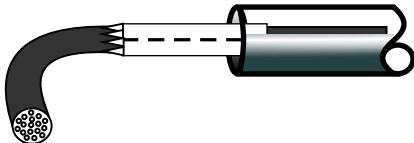
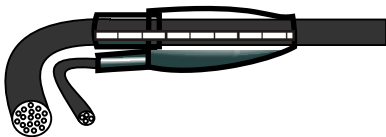
PART NUMBER	P.A.D.S CAT. NO	JOINT DESCRIPTION	JOINT STYLE
SPS 733 SPS 734	54/37084 54/37085	UP TO 5 PAIR 0.9mm CONDUCTORS UP TO 10 PAIR 0.9mm CONDUCTORS	H/S TUBE IN- LINE JOINT CLOSURE FOR REPAIRS TO SUB SPURE TEL. CABLES 
SPS 735 SPS 736 SPS 737	54/15849 54/15852 54/15853	5/10 PAIR COMPOUND FILLED CABLE 20/30 PAIR COMPOUND FILLED CABLE 50/75 PAIR COMPOUND FILLED CABLE	H/S TUBE IN -LINE JOINT CLOSURE WITH BRAID LINING 
SPS 738 SPS 739 SPS 740 SPS 897	87/4810 87/4811 87/4812 87/4813	5/10/20 PAIR COMPOUND FILLED CABLE 30/50 PAIR COMPOUND FILLED CABLE 70/100 PAIR COMPOUND FILLED CABLE 150 PAIR COMPOUND FILLED CABLE	WRAPAROUND SLEEVE IN -LINE OR BRANCH CLOSURE WITH LAMINATED LINER. BRANCH CLIP NOT INCLUDED 
SPS 741 SPS 742 SPS 743	54/37081 54/37082 54/37083	20 PAIR COMPOUND FILLED CABLE 50 PAIR COMPOUND FILLED CABLE 100 PAIR COMPOUND FILLED CABLE	H/S TUBE IN-LINE CLOSURE WITH METAL CANISTER ENCLOSURE 
SPS 1000 SPS 1001 SPS 1002	54/37062 54/37060 54/37061	5/10/20 PAIR COMPOUND FILLED CABLE 30/50 PAIR COMPOUND FILLED CABLE 70/100 PAIR COMPOUND FILLED CABLE	WRAPAROUND SLEEVE IN -LINE OR BRANCH CLOSURE WITH LAMINATED LINER. INCLUDES BRANCH CLIP 



Thorne & Derrick UK

Bristol Head Office

Tel: 0117 977 4647

Fax: 0117 977 5582

Northern Office

Tel: 0191 490 1547

Fax: 0191 477 5371

CCTV COAXIAL AND SUNDRY TELECOM KITS

PART NUMBER	P.A.D.S CAT. NO	JOINT DESCRIPTION	JOINT STYLE
SPS 744	54/15894	SINGLE OR DOUBLE SHEATHED CCTV COAXIAL CABLE TYPE A&B	
SPS 745	54/35012	URM 70 CAMERA CABLE TO TYPE A CCTV COAXIAL CABLE	
SPS 895	54/37139	MOISTURE SHIELD EARTH BOND AND CLIP	
SPS 932	54/37140	CAST RESIN CABLE SEALING CONE	---
SPS 936	54/37141	10-50 PAIR TERMINATING KIT WITH SHIELD BONDING KIT (PACK OF 5 KITS)	
SPS 949	54/37142	SHEATH GAPPING KIT FOR CABLES WITH METALLIC SHEATH	
SPS 972	54/37143	2-10 PAIR TERMINATING KIT WITH SHIELD BONDING KIT (PACK OF 5 KITS)	
SPS 973	54/37144	10-18mm DIA FIBRE OPTIC CABLE MOSITURE BARRIER KIT (PACK OF 10 KITS)	
SPS 353	54/37108	WRAPAROUND SEALING KIT TO REPAIR LEAKING PUTTY WIPES ON PRESSURISED CLOSURES	
JOINT CLOSURES FOR SEPARATE SCREENING CONDUCTOR CABLES			
SPS 851	54/37126	INLINE JOINT 150mm ² STR. AL. WITH CONNECTOR	
SPS 852	54/37127	SPUR JOINT 150mm ² STR. AL. TO 16mm ² STR. CU. WITH CONNECTOR	
SPS 853	54/37128	SPUR JOINT 150mm ² STR. AL. TO 150mm ² STR. AL. WITH CONNECTOR	

FOR DETAILS ON 250mm² SIZE COMBINATIONS, CONSULT SHRINK POLYMER SYSTEMS



Thorne & Derrick UK

Bristol Head Office

Tel: 0117 977 4647

Fax: 0117 977 5582

Northern Office

Tel: 0191 490 1547

Fax: 0191 477 5371

**HEATSHRINKABLE POLYOLEFIN TUBE
THIN WALL FLAME RETARDED 2:1 SHRINK RATIO**

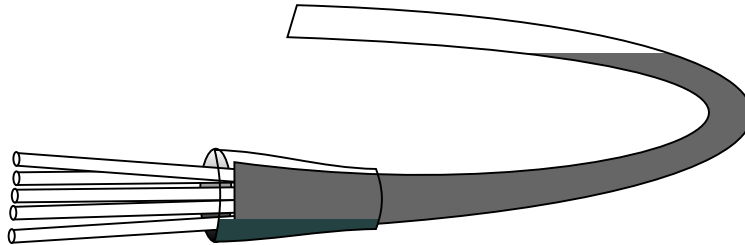

PART NUMBER	P.A.D.S CAT. NO	EXPANDED DIAMETER	RECOVERED DIAMETER	STANDARD LENGTH	RECOVERED THICKNESS	COLOUR RANGES
TWM 48	54/73439	4.8mm	2.4mm	60mtr	0.51mm	RED YELLOW BLUE BLACK CLEAR GREEN/YELLOW
TWM 64	54/73440	6.4mm	3.2mm	60mtr	0.64mm	
TWM 95	54/72441	9.5mm	4.8mm	60mtr	0.64mm	
TWM 127	54/73442	12.7mm	6.4mm	60mtr	0.64mm	
TWM 191	54/73443	19.1mm	9.5mm	60mtr	0.76mm	
TWM 254	54/44058	25.4mm	12.7mm	30mtr	0.89mm	
TWM 381	54/44059	38.1mm	19.1mm	30mtr	1.02mm	
TWM 508	54/44060	50.8mm	25.4mm	30mtr	1.14mm	

**HEATSHRINKABLE POLYOLEFIN TUBE
THICK WALL 3:1 SHRINK RATIO SEALANT LINED**

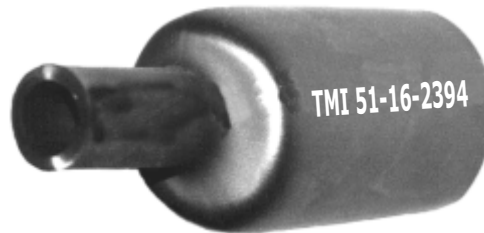

PART NUMBER	P.A.D.S CAT. NO	EXPANDED DIAMETER	RECOVERED DIAMETER	STANDARD LENGTH	RECOVERED THICKNESS	COLOUR RANGES
TMI 12-3	54/73436	12mm	3mm	1500mm	2.0mm	BLACK ONLY
TMI 22-6	54/73431	22mm	6mm	1500mm	2.5mm	
TMI 33-8	54/73432	33mm	8mm	1500mm	3.2mm	
TMI 45-12	54/73433	45mm	13mm	1500mm	4.1mm	
TMI 55-16	54/73434	55mm	16mm	1500mm	4.1mm	
TMI 69-22	54/73435	69mm	22mm	1500mm	4.1mm	
TMI 95-30	54/73437	95mm	30mm	1500mm	4.3mm	
TMI 130-36	54/73430	130mm	36mm	1500mm	4.3mm	
TMI 160-50	---	160mm	50mm	1500mm	4.3mm	



Thorne & Derrick UK

Bristol Head Office

Tel: 0117 977 4647

Fax: 0117 977 5582

Northern Office

Tel: 0191 490 1547

Fax: 0191 477 5371

HEATSHRINKABLE CABLE GLANDS FOR THE SUPPORT AND SEALING OF UNARMoured CABLES

Cables terminated into Railway Signalling equipment should be protected against the risk of accidental damage caused by external forces pulling at the Cable Termination connections and ingress of moisture which may result in equipment failure.

The HCS series of Heatshrinkable Standard and 'Modified' Cable Entry Glands were developed to provide a cost effective method of ensuring a secure support and weatherproof seal on all types of non armoured Railway Signalling Cable. The high shrink ratio heatshrinkable collar enables suitability for a range of Cable diameters.

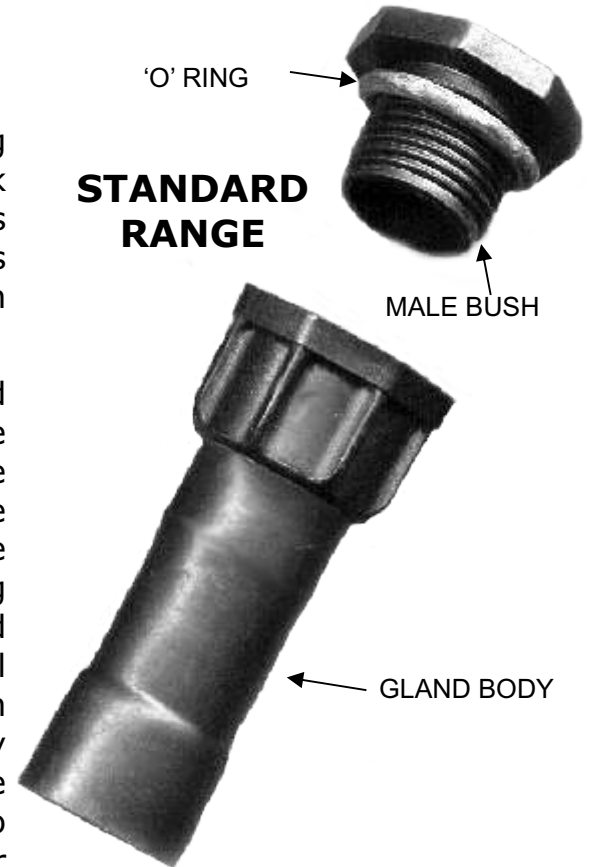
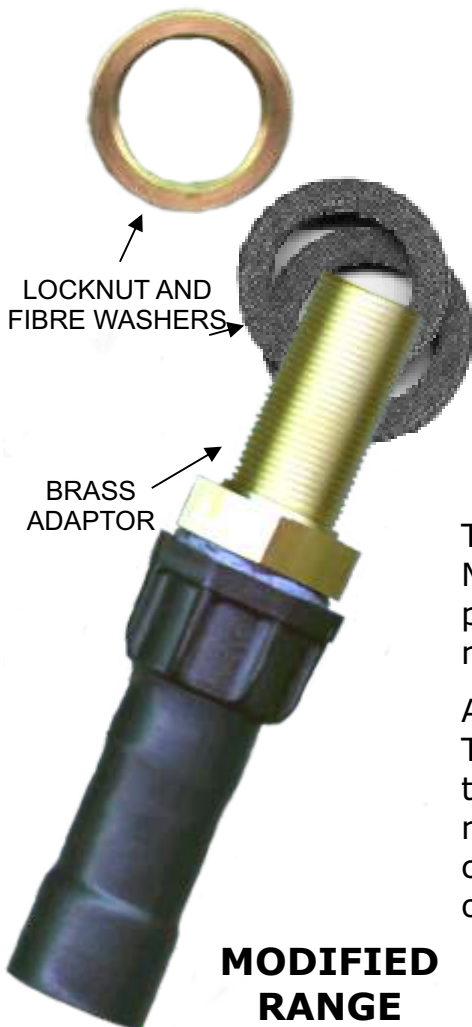

The Glands are manufactured in accordance with MIL-1-81765/1 and MIL-1-23053/15 specifications and provide a flame retarded adhesive lined body along with a male threaded bush to enable fixture to the Gland Plate.

A range of Glands are available complete with Brass Threaded Adaptor, Locknut and Fibre Washers to suit all types of Signalling and Switching equipment. The majority of Glands with Adaptors are intended to be clearance fit enabling them to be re-used upon servicing of the equipment.



Thorne & Derrick UK

Bristol Head Office

Tel: 0117 977 4647

Fax: 0117 977 5582

Northern Office

Tel: 0191 490 1547

Fax: 0191 477 5371

HEATSHRINKABLE CABLE GLANDS STANDARD RANGE - DIMENSIONAL DETAIL

PART NUMBER	P.A.D.S CAT. NO	CABLE DIA RANGE (mm)	MAX GLAND I.D (mm)	MAX PLATE THICKNESS (mm)	THREAD DIA (mm)	ENTRY HOLE DIA (mm)	EQUIVELENT P.A.D.S REFERENCE NUMBERS
HCS 1	54/109179	4-12	19	6	25	26	
HCS 2	54/109175	7-17	19	6	25	26	
HCS 3	54/109176	13-26	28	8	34	35	54/1003
HCS 4	54/109164	19-38	40	10	50	51	
HCS 4s	54/109165	19-53	53	10	59	60	
HCS 5	54/109181	36-70	73	18	86.5	88	

HEATSHRINKABLE CABLE GLANDS MODIFIED RANGE - DIMENSIONAL DETAIL

PART NUMBER	P.A.D.S CAT. NO	MAX CABLE DIA	MAX GLAND I.D	ENTRY HOLE DIA	EQUIVELENT P.A.D.S REFERENCE NUMBER
SPS 721	54/000092	18 mm	19 mm	25 mm	54/001002
SPS 722	54/000093	18 mm	19 mm	25 mm	54/037067
SPS 723	54/000094	15 mm	16 mm	20 mm	54/001001, 54/001005, 54/037056
SPS 724	54/000095	20 mm	21 mm	27 mm	54/037068, 54/037058
SPS 725	54/000096	25 mm	26 mm	32 mm	54/037059
SPS 726	54/000097	25 mm	26 mm	32 mm	54/001004, 54/037057
SPS 727	54/000098	28 mm	28 mm	32 mm	54/037055
SPS 728	54/000099	13.5 mm	14 mm	19 mm	54/037050, 54/037051



Thorne & Derrick UK

Bristol Head Office

Tel: 0117 977 4647

Fax: 0117 977 5582

Northern Office

Tel: 0191 490 1547

Fax: 0191 477 5371

HEATSHRINKABLE CABLE ENTRY SEALING GLANDS APPLICATION TABLE

The Equipment Application listed has been established with the co-operation of the NRS (Crewe) Technical Section.

Rail Equipment Cable entry apertures may vary depending on the equipment age, therefore it is highly recommended that this is taken into account when selecting a suitable Gland from the Table below.

EQUIPMENT P.A.D.S CAT. NO	EQUIPMENT DESCRIPTION	SCREW FIT GLAND OPTION	CLEARANCE FIT GLAND OPTION	STANDARD GLAND OPTION
87/37887-88-90	DAC & RACAL WEATHERPROOF TELEPHONES		SPS 728	
86/43476-86	ADTRANZ T1-21 TUNING UNITS			HCS 2
86/43743-44-49-67-73	ML ASTER TUNING UNITS			HCS 2
86/9130 to 86/9137	NRS STANDARD SIGNAL HEADS			HCS 3
86/28779	AUTOMATIC OPEN, CONTROLLED LOCALLY (AOCL UNITS)			HCS 2
86/1258-59	FIBRE OPTIC STENCIL & THEA TRE INDICATORS			HCS 2
86/41070-71	POSITION LIGHT GROUND SIGNALS	SPS 724		
86/1262	SIGNAL HOUSE-OPTIC FIBRE LIT SIGNALS TYPE PL1W, PL1R AND PL2R		SPS 726	
86/32113	CLAMPLOCK & DETECTOR MECHANISM ASSEMBLY	SPS 726		HCS 2
86/32521-41	ELECTRO HYDRAULIC POWER PACKS (PUMP UNITS)		SPS 725	
86/41451	SIGNAL POST REPLACEMENT SWITCHES	SPS 726		
86/46305-310-315	DOUBLE ARM TREADLE SWITCHES	SPS 727		
86/46300	SINGLE ARM TREADLE SWITCHES	SPS 727		HCS 2
86/32650	TRAIN OPERATED POINTS ACCUMULATOR UNITS			
86/30000	ELECTRICAL DETECTOR BOXES	SPS 727		
88/19195	TRAIN STOPS	SPS 727		
86/7273 to 76	4&6 WAY ROTARY CONTROLLERS	SPS 727		
	WSL OLD STYLE P3 IMPEDANCE BONDS	SPS 727		
86/17023-24	WSL & HOWELL'S TYPE 2&3 IMPEDANCE BONDS (4 x 20mm HOLES)		SPS 723	
86/17024	WSL & HOWELL'S TYPE 3 IMPEDANCE BONDS (1 x 26mm HOLE)		SPS 721	
86/17023	WSL TYPE 2 IMPEDANCE BOND (26mm HOLE)		SPS 724	
86/17023	HOWELL'S TYPE 2 IMPEDANCE BOND (LARGE 26mm HOLE)		SPS 721	
62/6736-37	AWS ELECTRO INDUCTORS HOWELL'S STANDARD & EXTRA STRENGTH		SPS 721	
62/6781-85	AWS SUPPRESSOR INDUCTORS HOWELL'S STANDARD & EXTRA STRENGTH	SPS 724	SPS 722	
88/381-383	ALSTOM HW POINT MACHINES	SPS 727	SPS 725	
88/12008-88- 88/81253	WSL STYLE 63 POINT MACHINES			HCS 4
55/121369-370	POINT HEATER TRANSFORMER 20mm PORT		SPS 723	
55/121369-370	POINT HEATER TRANSFORMER 26mm PORT		SPS 724	HCS 2
55/121369-370	POINT HEATER TRANSFORMER 32mm PORT		SPS 725	



Thorne & Derrick UK

Bristol Head Office

Tel: 0117 977 4647

Fax: 0117 977 5582

Northern Office

Tel: 0191 490 1547

Fax: 0191 477 5371

ZERO HALOGEN LSF CABLE JOINTS FOR LIMITED FIRE HAZARD CABLES



- Fire tested and compliant with London underground standards 2-0100-002 or the fire safety of materials and E4156 for the cable standard
- Slim profile and unlimited shelf life Complete with range taking mechanical shearbolt connectors
- Full range of joints available for all cable types including power and multicore cables

Thorne & Derrick can now offer a range of heatshrink joints suitable for both single and multicore low smoke fume zero halogen cables.

Developed for London Underground for use within the tunnels and above surface, the system incorporates flame retardant, non halogen polyolefin heatshrink tubing with a meltable inner liner that itself has excellent flame retardant properties with reduced acid gas emission and smoke generation.



The system incorporates a flexible outer fire barrier tube that provides a high degree of fire resistance. For installations outside of the tunnels this can be omitted.

For ease of use, the range comes complete with range finding mechanical shearbolt connectors. Slim in profile the joints can be installed in horizontal and vertical planes and have an unlimited shelf life.

HEATSHRINK JOINTS TO SUIT 1-4 CORE XLPE/SWALSOH		
PART NUMBER	CABLE RANGE	VOLTAGE
SPA NHF 1.5-2.5-	1.5 - 2.5mm ²	600/1000V
SPA NHF 4-6-	4 - 6mm ²	600/1000V
SPA NHF 10-16-	10 - 16mm ²	600/1000V
SPA NHF 25-50-	25 - 50mm ²	600/1000V
SPA NHF 70-95-	70 - 95mm ²	600/1000V
SPA NHF 120-185-	120 - 185mm ²	600/1000V
SPA NHF 240-300-	240 - 300mm ²	600/1000V
SPA NHF 400-630-	400-630mm ²	600/1000V
SPA NHF 800-1000-	800-1000mm ²	600/1000V

Notes:-

- 1 For non armoured joints, omit letter (A) from the part number
- 2 Add last digit to part number to indicate number of cores



Thorne & Derrick UK

Bristol Head Office

Tel: 0117 977 4647

Fax: 0117 977 5582

Northern Office

Tel: 0191 490 1547

Fax: 0191 477 5371

ADDITIONAL PRODUCTS

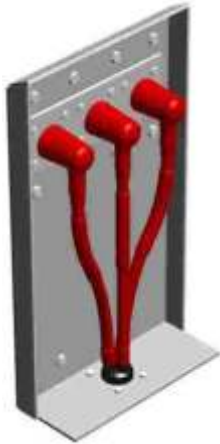

Medium Voltage Terminations and Joints

A range of Heatshrink Joints and Terminations for Paper and Polymeric Insulated Cables up to voltages of 36kV.

Low Voltage Terminations and Joints

A range of Heatshrink Joints and Terminations for Paper and Polymeric Insulated Cables for voltages 0.6/3.6kV

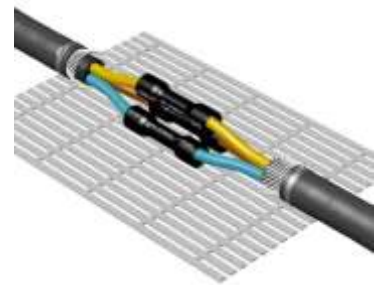

Heatshrink Busbar Tube and Zero Halogen Tube

A range of red highly flexible Busbar Insulation Tubing is available for applications up to 36kV.

Also available on their own or incorporated within Joints kits are Thin, Medium and Thick Wall Heatshrink Tube products for LSF and Zero Halogen applications.

Tapes

A variety of Tapes are available including Melt Tapes, Heatshrink Tapes, Zero Halogen, Stress Control and EPR Rubber Tapes..

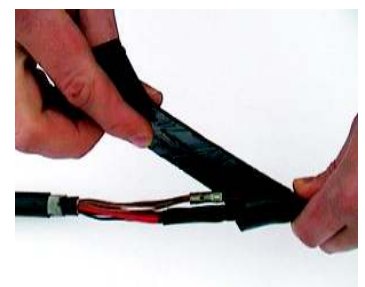



Thorne & Derrick UK

Bristol Head Office

Tel: 0117 977 4647

Fax: 0117 977 5582

Northern Office

Tel: 0191 490 1547

Fax: 0191 477 5371

P.A.D.S CAT. NO. / PART NO. / PAGE NO. CROSS REFERENCE LIST

CAT NO	SPS PART NO	PAGE	CAT NO	SPS PART NO	PAGE	CAT NO	SPS PART NO	PAGE	CAT NO	SPS PART NO	PAGE
40/17801	SPS 202	1	54/15874	SPS 073	8	54/37079	SPS 107	7	54/43488	SPS 697	2
54/000092	SPS 721	15	54/15875	SPS 094	4	54/37081	SPS 741	11	54/44058	TWM 254	13
54/000093	SPS 722	15	54/15877	SPS 108	7	54/37082	SPS 742	11	54/44059	TWM 381	13
54/000094	SPS 723	15	54/15878	SPS 105	9	54/37083	SPS 743	11	54/44060	TWM 508	13
54/000095	SPS 724	15	54/15879	SPS 106	9	54/37084	SPS 733	11	54/73429	TMI 122-40-1200	13
54/000096	SPS 725	15	54/15880	SPS 076	8	54/37085	SPS 734	11	54/73430	TMI 90-30-1500	13
54/000097	SPS 726	15	54/15886	SPS 080	9	54/37088	SPS 201	1	54/73431	TMI 22-6-1500	13
54/000098	SPS 727	15	54/15889	SPS 134	8	54/37090	SPS 748	9	54/73432	TMI 30-8-1500	13
54/000099	SPS 728	15	54/15891	SPS 103	9	54/37092	SPS 702	6	54/73433	TMI 40-12-1500	13
54/10716	C10-4	10	54/15892	SPS 104	9	54/37093	SPS 970	6	54/73434	TMI 51-16-1500	13
54/109164	HCS 4	15	54/15894	SPS 744	12	54/37094	SPS 980	6	54/73435	TMI 68-22-1500	13
54/109165	HCS 4S	15	54/18606	SWRS 75-22-1000	10	54/37095	SPS 711	9	54/73436	TMI 12-3-1200	13
54/109175	HCS 2	15	54/18607	SWRS 188-55-1000	10	54/37096	SPS 712	9	54/73437	TMI 90-30-1500	13
54/109176	HCS 3	15	54/18608	SWRS 105-30-1000	10	54/37097	SPS 713	9	54/73439	TWM 48	13
54/109179	HCS 1	15	54/18609	SWRS 146-38-1000	10	54/37098	SPS 714	9	54/73440	TWM 64	13
54/109181	HCS 5	15	54/18610	SWRS 35-10-1000	10	54/37099	SPS 715	9	54/73441	TWM 95	13
54/12051	C 40-15	10	54/18640	SWRS 50-15-1000	10	54/37100	SPS 716	9	54/73442	TWM 127	13
54/12052	C63-25	10	54/31016	SPS 863	1	54/37101	SPS 832	9	54/73443	TWM 191	13
54/12053	C76-30	10	54/35012	SPS 745	12	54/37102	SPS 975	9	86/43489	SPS 115	2
54/12054	C20-8	10	54/36100	SPS 081	9	54/37108	SPS 353	12	86/43498	SPS 116	2
54/120989	TMI 22-6-55	2	54/36101	SPS 109	5	54/37114	SPS 944	7	86/43499	SPS 117	2
54/120991	SPS 701	2	54/36102	SPS 110	5	54/37115	SPS 916	9	86/44013	SPS 696	2
54/121906	TWM 381 RED	13	54/36103	SPS 111	5	54/37120	SPS 703	8	86/44017	SPS 700	3
54/13658	SPS 077	10	54/36106	SPS 114	5	54/37121	SPS 704	8	86/44019	SPS 695	3
54/15289	SPS 099	4	54/37005	SPS 095	4	54/37122	SPS 705	8	86/44021	SPS 699	3
54/15759	SPS 079	9	54/37009	SPS 075	8	54/37123	SPS 706	8	86/4810	SPS 738	11
54/158116	TMI 30-8-55	2	54/37012	SPS 101	9	54/37124	SPS 707	8	87/10037	SPS 698	11
54/15846	SPS 709	8	54/37052	SPS 096	10	54/37125	SPS 747	7	87/4811	SPS 739	11
54/15848	SPS 710	8	54/37053	SPS 097	10	54/37126	SPS 851	12	87/4812	SPS 740	11
54/15849	SPS 735	11	54/37054	SPS 098	10	54/37127	SPS 852	12	87/4813	SPS 897	11
54/15852	SPS 736	11	54/37060	SPS 1001	11	54/37128	SPS 853	12	87/64087	SPS 983	6
54/15853	SPS 737	11	54/37061	SPS 1002	11	54/37139	SPS 895	12	87/64088	SPS 984	6
54/15857	SPS 102	9	54/37062	SPS 1000	11	54/37140	SPS 932	12	87/64089	SPS 985	6
54/15870	SPS 071	8	54/37070	SPS 720	10	54/37141	SPS 936	12			
54/15871	SPS 072	8	54/37074	SPS 717	9	54/37142	SPS 949	12			
54/15872	SPS 074	8	54/37077	SPS 719	8	54/37143	SPS 972	12			
54/15873	SPS 100	4	54/37078	SPS 718	8	54/37144	SPS 973	12			

COPY THIS PAGE AND RETURN FOR ASSISTANCE AS FOLLOWS

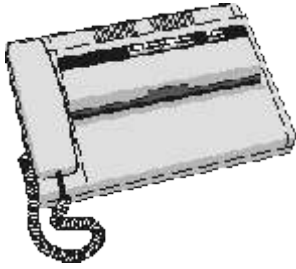

Thorne & Derrick UK

Bristol Head Office

Tel: 0117 977 4647

Fax: 0117 977 5582

Northern Office

Tel: 0191 490 1547

Fax: 0191 477 5371

TICK ALL THAT APPLY

Please add me to your mailing list for future updates.

Please post me _ _ _ _ additional copies of this Catalogue.

Please Telephone me.

Please arrange for someone to visit.

I have a cabling problem that possibly requires a new Cable Joint design, Please call me.
(Most of the kits available were brought about this way)

Name: _____

Position: _____

Company: _____

Address: _____

Telephone: _____

Fax: _____

Email: _____