



CABLE JOINTS, CABLE TERMINATIONS, CABLE GLANDS, CABLE CLEATS
FEEDER PILLARS, FUSE LINKS, ARC FLASH, CABLE ROLLERS, CUT-OUTS

11KV 33KV CABLE JOINTS & CABLE TERMINATIONS
FURSE EARTHING
www.cablejoints.co.uk
Thorne and Derrick UK

Tel 0044 191 490 1547 Fax 0044 191 477 5371
Tel 0044 117 977 4647 Fax 0044 117 9775582



Contents

The Company	3
Why MCT Brattberg	4
The Products	10
Multiple Frames	14
Planning The Packing Space	16
Frames, Marine/Offshore	18
Frames, Civil/Industry	26
Circular RGP Frames & Seals	28
Blocks And Components	30
Frames Installation Methods	39
Packing Guides	42
EMC Protection	46
Deck & Bulkhead Glands	50
SR Cable & Pipe Seals	54
MSR Cable & Pipe Seals	56
X-Series Cable Transit	58
Transit Planning Software	60
Technical Guidance	62

MCT Brattberg The Company And Its History

MCT Brattberg's earliest origins reach as far back as 1759, a time when Lyckeåborg was designated the site for the construction of a copper hammer. The Lyckeby River waterfall made the location ideal.

Its modern history started after World War II, when the company was given the name Lyckeåborgs Bruk. The mechanical workshop made a variety of products, among them the well-known cut nail.

The 1950s saw the manufacture of a new product, the MCT Brattberg cable and pipe transit, named after its inventor Nils Brattberg. The MCT Brattberg System is a modular fire and pressure resistant cable transit for the shipyard and construction industries. Indeed, the product has brought the company global renown.

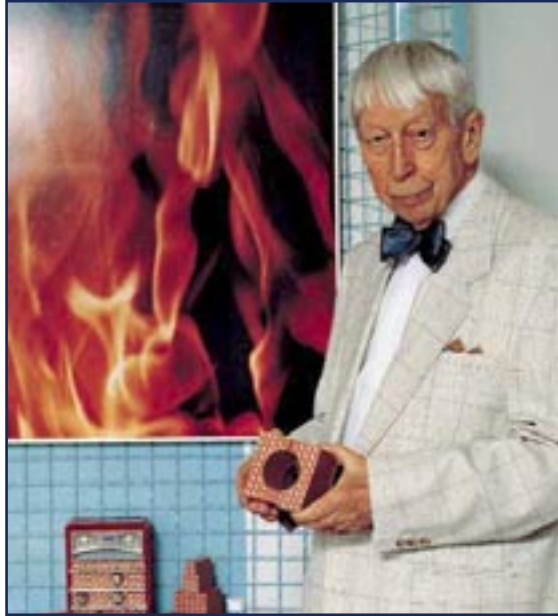

MCT Brattberg has evolved over the years - in the process defining an entire niche in the industry - in order to meet ever tougher demands on quality. The early 80s signalled the end of nail manufacture, and resources were focused on the MCT Brattberg products.

In 1986 Lyckeåborgs Bruk became Lycab and from 1999, MCT Brattberg. Today, the company is a modern industrial company where the MCT Brattberg System remains the main product. An extensive global dealer network ensures the product's availability in most markets. Exports from Sweden constitute roughly 85% of sales.



A Genuine Seal

Based on the simple but clever idea of a frame with insert blocks and an end seal, the MCT Brattberg is the original Transit System.

The MCT Brattberg was patented in the early 1950s. When oil rigs and nuclear power stations demanded cable and pipe installations with proven safety records. The MCT Brattberg system became a worldwide solution. And we've been improving it ever since. Comprehensive documentation shows that its resistance to fire, water, gas and pressure meet the latest safety requirements.

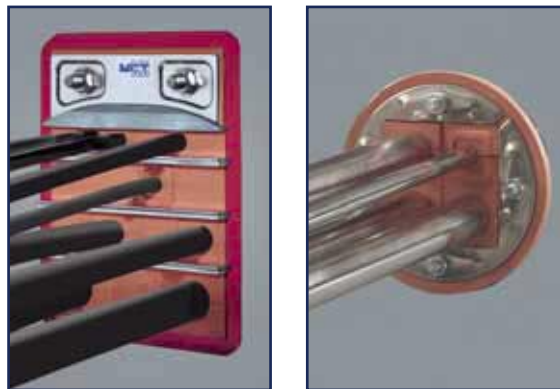

- The Company
- Why MCT Brattberg
- The Products
- Multiple Frames
- Planning the Packing Space
- Frames for Marine/Offshore
- Frames for Civil/Industry
- RGP Frames & Seals
- Blocks & Components
- Frame Installation Methods
- Packing Guides
- EMC Protection
- Deck & Bulkhead Glands
- SR Cable & Pipe Seals
- MSR Cable Glands
- X-Series Cable Transit
- Transit Planning Software

Prepare For More Than A Fire

MCT Brattberg provides a tested and certified seal that protects human lives and equipment against hazards and harsh environments. Cable and pipe penetration seals are installed in the onshore and offshore environment to maintain the fire and water integrity of walls and floors.



Fire

Tested for integrity and insulation criteria



Smoke & Fumes

Prevents the passage of smoke and fumes when exposed to fire.



Explosion

Can withstand an explosion up to 23 Bar without the seal integrity being compromised.



Mechanical Anchorage

Capable of supporting the weight of cables and pipes should there be any failure of the tray or ladder support systems when fire strikes.



Sound

Effectively dampens the sound transmission (up to 53 dB) between two adjacent areas.



Vibration

Capable of withstanding vibration from 5-33Hz without any detrimental effect to the system.

Electromagnetic Pulse & Interference

Has the ability to protect against EMP and EMI induced currents generated by Lightning Strikes or Nuclear Explosion.

Chemical Resistance

Materials of construction show a high degree of resistance when subjected to a variety of chemicals.

Accelerated Heat Ageing

Heat ageing showed little deterioration of hardness, tensile strength or elongation at break.

Gamma Radiation

Subjected to 2×10^8 Rads of Gamma Radiation with no detrimental effect.

Rodents

Subjected to rodents for three weeks without any signs of deterioration to the seal.

Temperature Cycling

Tested to MOD specifications and is suitable for use in areas where severe temperature changes from -10°C to $+55^{\circ}\text{C}$ may occur.

Test Certificates for any of the above available upon request.

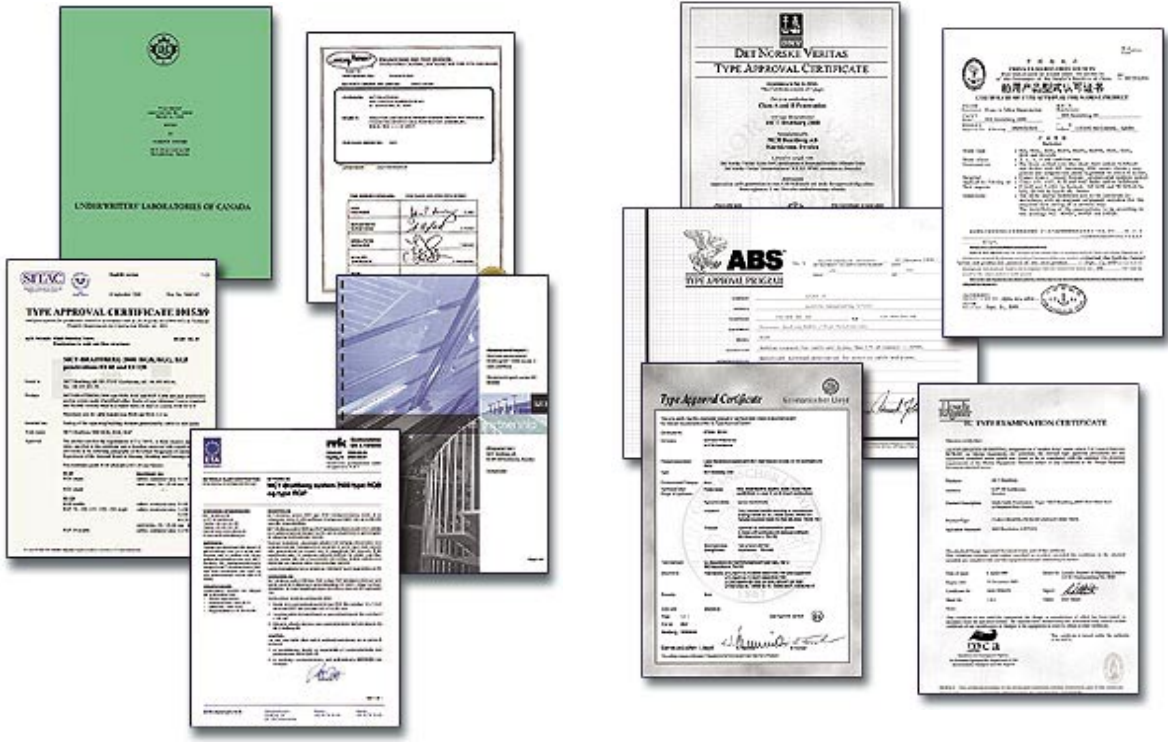

- The Company
- Why MCT Brattberg
- The Products
- Multiple Frames
- Planning the Packing Space
- Frames for Marine/Offshore
- Frames for Civil/Industry
- RGP Frames & Seals
- Blocks & Components
- Frame Installation Methods
- Packing Guides
- EMC Protection
- Deck & Bulkhead Glands
- SR Cable & Pipe Seals
- MSR Cable Glands
- X-Series Cable Transit
- Transit Planning Software

Organisation	Type Of Approval
ABS	Fire A-class, H-class
US Coast Guard	Fire A-class
Canadian Coast Guard	Fire A-class
Bureau Veritas	Fire A-class, Pressure
China Class. Soc.	Fire A-class
Australian Mar. Safety	Fire A-class
DNV	Fire A-class, H-class
DNV	Pressure
Danish Maritime Auth.	Fire A-class
Korean Reg. of Shipping	Fire A-class
Lloyds Register	Fire A-class, H-class
Lloyds Register	Pressure
Lloyds Register	Jet Fire
Polski Rej. Statkow	Fire A-class, Pressure
Germanischer Lloyd	Fire A-class
Swe. Adm. of Shipping	Fire A-class
Croatian Register	Fire A-class
Russian Maritime Reg.	Fire A-class
RINA	Fire A-class
BRE	Fire BS476 PT 20
LCIE	ATEX

Production; Our Quality System

MCT Brattberg's production process is ISO 9001: 2000 certified. Every product in our system is produced according to a tried and tested quality control system – which is fully documented.

The images show robot welding of steel frames, a process that ensures consistently high quality. Other images show various phases of quality control.

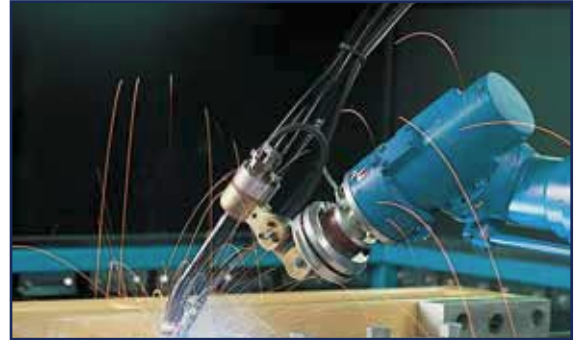

Frames That Take The Strain

Bulkheads onboard large vessels move around according to the sea and the temperature. Because we have full control over our production process – from raw material to finishing treatment our frames can cope with the movement caused by extreme conditions.

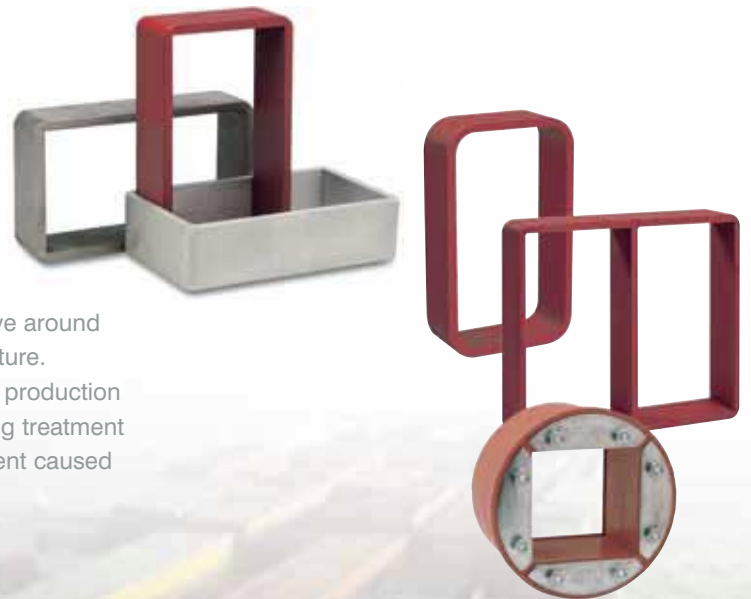

The Quality Of Our Rubber

We make our insert blocks out of Lycron, a halogen-free synthetic polymer that was developed for its fire resistant qualities. When Lycron is exposed to extreme heat it doesn't crack, and it doesn't release poisonous or corrosive gases. Each insert block is manufactured to precise measurements to ensure an easily fitted seal.

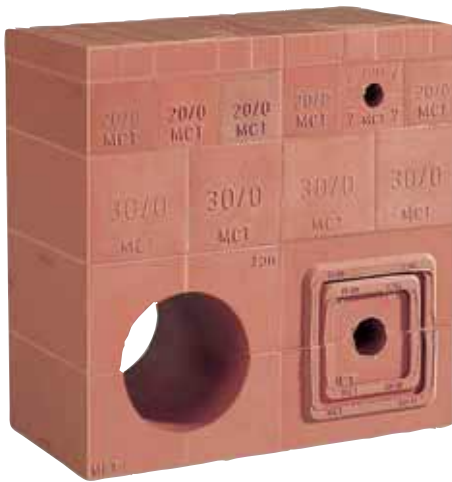

Flexibility

All insert blocks in the MCT Brattberg range are based on the same idea. The Standard-block can be freely combined with Add-block and U-block to give maximum flexibility.

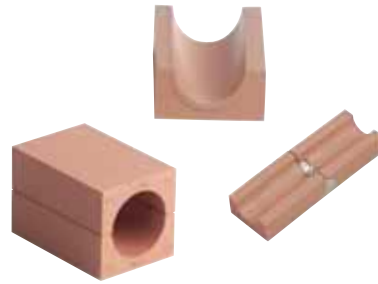

Standard blocks are available for cable diameters from 4-100mm. Other dimensions can be supplied to order.

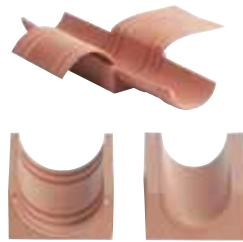

AddBlocks can be adapted to fit any of five different cable or pipe dimensions.

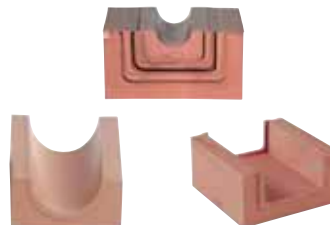

The U-Block is used to convert the external dimensions of Insert Blocks, AddBlocks and Spare Blocks to the next modular size.

- The Company
- Why MCT Brattberg
- The Products
- Multiple Frames
- Planning the Packing Space
- Frames for Marine/Offshore
- Frames for Civil/Industry
- RGP Frames & Seals
- Blocks & Components
- Frame Installation Methods
- Packing Guides
- EMC Protection
- Deck & Bulkhead Glands
- SR Cable & Pipe Seals
- MSR Cable Glands
- X-Series Cable Transit
- Transit Planning Software

Applications

The MCT Brattberg Transit System is more than a fire barrier, it is a multi-functional system developed to give protection in high risk environments.



MCT Brattberg is a flexible system with the ability to seal cables and pipes of varying diameters. Offshore oil platforms, FPSO's, Commercial Ships and High Rise Buildings, where people could be trapped on levels above a fire, require barriers to prevent the spread of smoke and hot gasses into escape routes.



Laboratories are one of the few environments where containment of chemical contamination is paramount. MCT Brattberg's materials are resistant to an array of chemical substances.



Where highly volatile substances are stored and manufactured, MCT Brattberg protects against explosions up to 23 bar.



Telecommunication and banking networks are at risk from EMI/EMP interference; this can be successfully eliminated by using the E-MCT Brattberg system.



Technical Information

Pressure Installations

- 1** Ensure the internal frame surfaces are clean and free from corrosion.
- 2** Liberally lubricate the internal frame surfaces.
- 3** Install blocks and components as detailed on pages 42 - 45, "Packing Guide", ensuring all parts are adequately lubricated.
- 4** The transit system must be allowed to settle for 48 hours before any pressurisation.
- 5** Lycron pre-lubricated transits are tested to 5 bar and certified by Lloyds.
- 6** 1 Bar = 14.7 PSI = 10 metres head of water

Pressure Installations For RGP

- 1** Clean the insides of the pipe sleeves ensuring surfaces are free from corrosion.
DO NOT lubricate inside pipe or outside RGP.
- 2** Liberally lubricate the insert blocks.
- 3** Install insert blocks as shown on page 45, "Installation guide".
- 4** The transit system must be allowed to settle for 48 hours before any pressurisation.
- 5** Lycron pre-lubricated RGP's are tested to 5 bar and certified by Lloyds.
- 6** 1 Bar = 14.7 PSI = 10 metres head of water

MCT Brattberg Has The Following Facilities To Provide Type Test Approval To Meet Customer Requirements

- 300 Bar pressure vessel
- Horizontal and vertical fire oven
- X-Ray cabinet
- Climate chamber
- Leak detection
- Mechanical, NDE and other various electrical testing facilities

- The Company
- Why MCT Brattberg
- The Products
- Multiple Frames
- Planning the Packing Space
- Frames for Marine/Offshore
- Frames for Civil/Industry
- RGP Frames & Seals
- Blocks & Components
- Frame Installation Methods
- Packing Guides
- EMC Protection
- Deck & Bulkhead Glands
- SR Cable & Pipe Seals
- MSR Cable Glands
- X-Series Cable Transit
- Transit Planning Software

Frames For Marine And Offshore

MCT Brattberg's range of transit frames, for both welding and bolting, meet the various requirements of offshore and marine applications. RGS is the most common frame type. RGSF & RGSFB withstands the powerful movement of bulkheads and decks. RGSC is a frame for use in high stress areas. RGSK is a deeper frame for use on outer decks.



RGS



Multiple Frames



RGSF



RGSFB



RGSC



RGSK

Frames For Civil And Industry

MCT Brattberg has frames for both casting into the structure (RGB frame), and mounting in lightweight wall constructions (RGG frame).



RGB/RGBO



RGG



RGGO

- The Company
- Why MCT Brattberg
- The Products**
- Multiple Frames
- Planning the Packing Space
- Frames for Marine/Offshore
- Frames for Civil/Industry
- RGP Frames & Seals
- Blocks & Components
- Frame Installation Methods
- Packing Guides
- EMC Protection
- Deck & Bulkhead Glands
- SR Cable & Pipe Seals
- MSR Cable Glands
- X-Series Cable Transit
- Transit Planning Software

Sleeves For Marine/Civil



S

The type S is a marine pipe sleeve for installation where the hole can be accurately cut to suit the external profile (see page 39 for welding instructions). It is manufactured from 6mm thick seamless pipe.



SFR

The type SFR is a marine/civil sleeve with a round flange 6mm thick.



SFRB

The type SFRB is a marine/civil sleeve with a round flange 6mm thick and fixing holes.

RGP

The RGP seals cables & pipes from 4-168mm in diameter. Installed in steel sleeves, pre-cast or core drilled holes.



Modular Sealing System

Module Blocks

MCT Brattberg's insert blocks are manufactured from Lycron, a synthetic polymer that was developed to withstand fire, explosions, temperature variation, ageing, radiation and rodents.

The blocks are injection moulded giving precision components to a high degree of accuracy.

Standard blocks are available for cable diameters from 4-100mm. Other dimensions can be supplied to order.

Each AddBlock can be adapted to five different cable dimensions.

U-blocks are used to increase the outside dimensions of all blocks to the next module size.

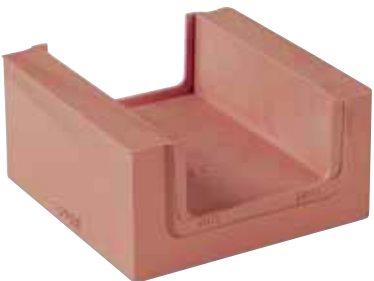

U-Blocks



Add Blocks



Standard Insert Blocks



Spare Blocks

- The Company
- Why MCT Brattberg
- The Products**
- Multiple Frames
- Planning the Packing Space
- Frames for Marine/Offshore
- Frames for Civil/Industry
- RGP Frames & Seals
- Blocks & Components
- Frame Installation Methods
- Packing Guides
- EMC Protection
- Deck & Bulkhead Glands
- SR Cable & Pipe Seals
- MSR Cable Glands
- X-Series Cable Transit
- Transit Planning Software

Multiple Frames

Horizontal Multiple Frames

Horizontal multiple frames are described by listing the frame type and size x the desired number of horizontal openings.



Vertical Multiple Frames

Vertical multiple frames are described by listing the frame type and bottom size + the next frame size.

Vertical And Horizontal Multiple Frames

Vertical & horizontal multiple frames are described by listing the frame type and bottom size + next sizes x the desired number of openings.

NOTE: All multiple frame designations must be preceded by the frame type.

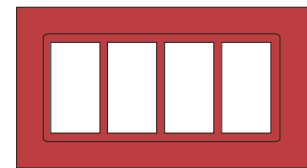

x 1 x 2 x 3 x 4

Designation (frame type) x4

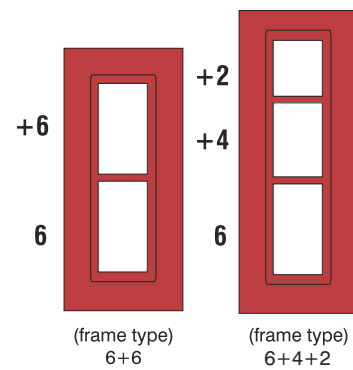

(frame type)
6+6

(frame type)
6+4+2

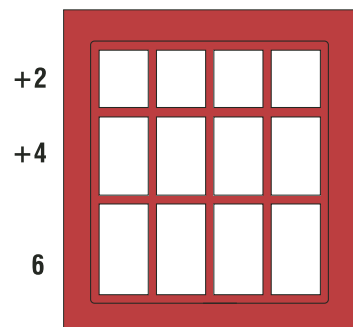

x 1 x 2 x 3 x 4

(frame type)
6+4+2x4

Horizontal Multiple Frames

Horizontal multiple frames are described by listing the frame type and size x the desired number of horizontal openings.



Vertical Multiple Frames

Vertical multiple frames are described by listing the frame type and bottom size + the next frame size.

Vertical And Horizontal Multiple Frames

Vertical & horizontal multiple frames are described by listing the frame type and bottom size + next sizes x the desired number of openings.

NOTE: All multiple frame designations must be preceded by the frame type.

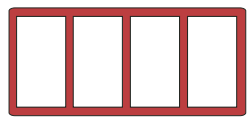

x 1 x 2 x 3 x 4
Designation (frame type) x4

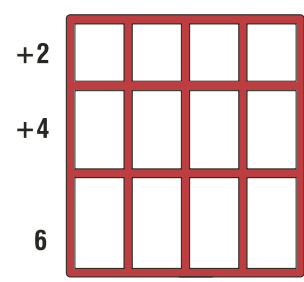
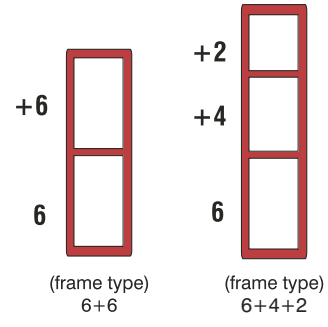

x 1 x 2 x 3 x 4
(frame type)
6+4+2x4

- The Company
- Why MCT Brattberg
- The Products
- Multiple Frames**
- Planning the Packing Space
- Frames for Marine/Offshore
- Frames for Civil/Industry
- RGP Frames & Seals
- Blocks & Components
- Frame Installation Methods
- Packing Guides
- EMC Protection
- Deck & Bulkhead Glands
- SR Cable & Pipe Seals
- MSR Cable Glands
- X-Series Cable Transit
- Transit Planning Software

Planning The Packaging Space

Whenever possible MCT Brattberg recommend the largest cables/pipes are fitted in the bottom of the frame.

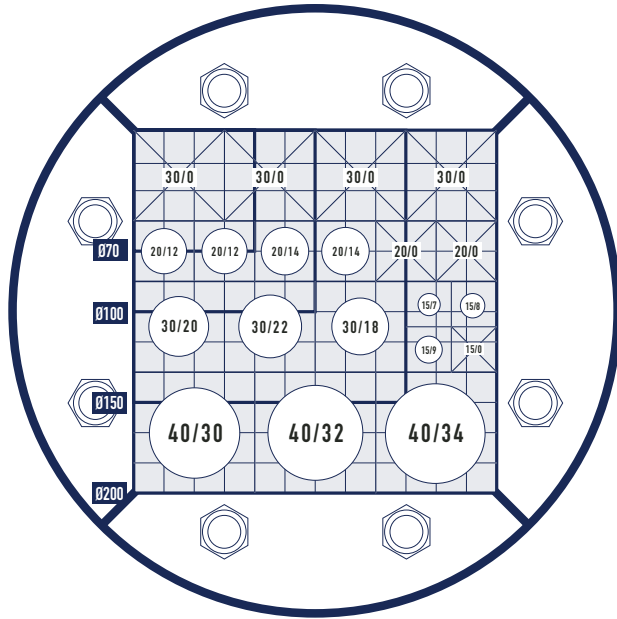

Insert Block Range		
Module size	Available hole diameters	mm Steps
15 x 15mm	4-9mm	1mm
20 x 20	4-16	1mm
30 x 30	12-24	1mm
40 x 40	22-34	2mm
60 x 60	32-54	2mm
90 x 90	50-70	2mm
120 x 120	72-100	2mm

Combination Width vs Cable Tray Width					
Frame Size	Cable tray's width in mm				
	150	200	300	400	600
2	2x1	2x2	2x3	2x4	2x5
4	4x1	4x2	4x3	4x4	4x5
6	6x1	6x2	6x3	6x4	6x5
8	8x1	8x2	8x3	8x4	8x5

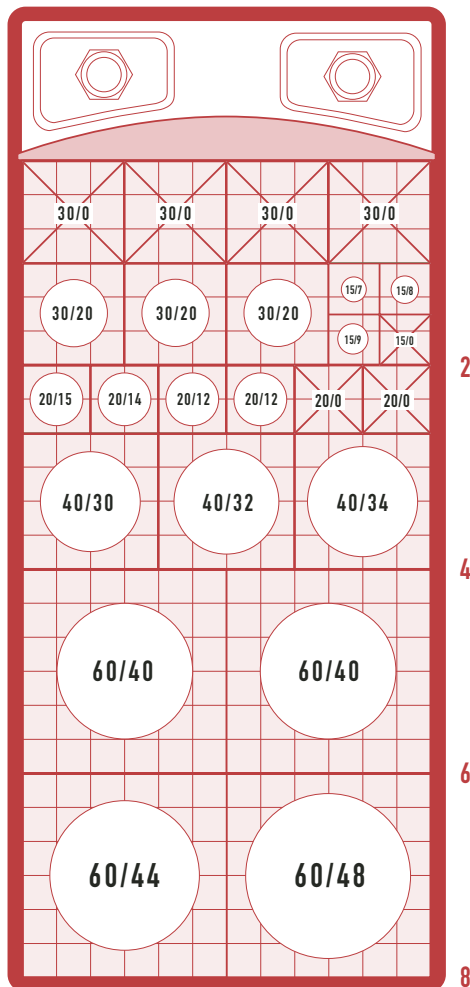

Frame Size	Maximum Number Of Cables And Pipes						
	Block Sizes						
	15	20	30	40	60	90	120
RGP 50/L30	4	1	1	-	-	-	-
RGP 50/L60	1	1	-	-	-	-	-
RGP 70	4	4	1	1	-	-	-
RGP 100	16	9	4	1	1	-	-
RGP 125	25	16	4	4	1	-	-
RGP 150	36	16	9	4	1	1	-
RGP 200	64	36	16	9	4	1	1

Frame Size	Maximum Number Of Cables And Pipes						
	Block Sizes						
	15	20	30	40	60	90	120
2	32	18	8	3	2	-	-
4	64	36	16	9	4	1	1
6	96	54	24	12	6	2	1
8	128	72	32	18	8	2	2

RG-PLAN

The correct frame size can be determined by using this plan. The numbers **2, 4, 6** and **8** in the margin represent the packing space available in frame sizes 2, 4, 6 and 8 respectively.

RGP-PLAN

The correct frame size can be determined by using this plan. The numbers **50, 70, 100, 125, 150** and **200** represent the packing space available in frames RGP-50, 70, 100, 125, 150 and 200 respectively.

RGP 300 (not shown)
Packing space 180 x 180mm.
Details available on request.

For large installations a computer software package is available to assist the design, layout and purchase of the correct transit frame and inserts. (See page 60 for more details).

RG/RGP-plans will be supplied free of charge on request.

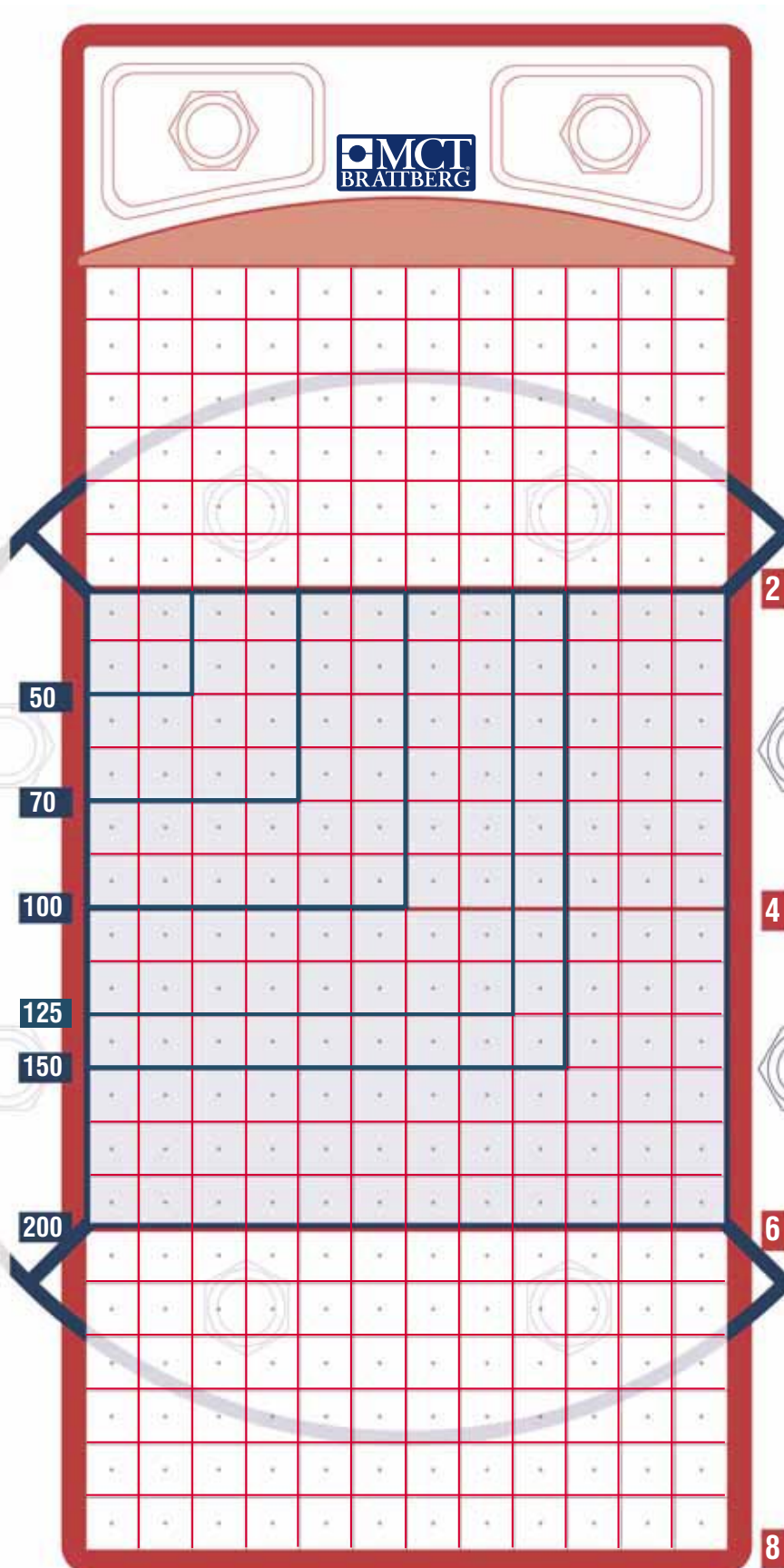

The Company

Why MCT Brättberg

The Products

Multiple Frames

Planning the Packing Space

Frames for Marine/Offshore

Frames for Civil/Industry

RGP Frames & Seals

Blocks & Components

Frame Installation Methods

Packing Guides

EMC Protection

Deck & Bulkhead Glands

SR Cable & Pipe Seals

MSR Cable Glands

X-Series Cable Transit

Transit Planning Software

RGS RGSO With Removable End

RGS is MCT Brattberg's standard frame for marine applications. It has a standard internal width of 120mm, is 60mm deep and is manufactured from 10mm thick materials. There are four sizes of RGS, denoted by 2, 4, 6 and 8 depending on their height. They may be combined vertically & horizontally to create multiple frames.

The RGS is welded into an accurately precut hole in the deck or bulkhead. As with all our frames, RGS is produced in mild steel, stainless steel, or aluminium. For installations where cables are already in place, select RGSO, which has a removable end.

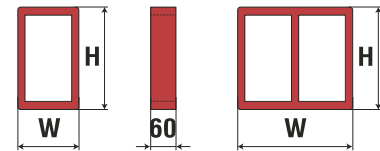

RGS 6

RGS 6 x 2

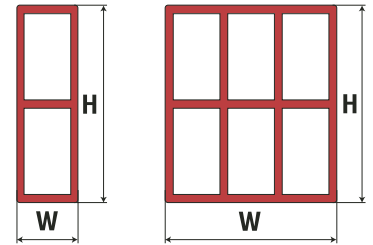

RGS 6 + 6

RGS 6 + 6 x 3

Size In mm								
Frame Size	(Height)	W (width) / Multiple Frames						
		x 1	x 2	x 3	x 4	x 5	x 6	x n
RGS-2	121	140.5	271	401.5	532	662.5	793	W = 10 + 130.5 x n
RGS-4	179.5	"	"	"	"	"	"	
RGS-6	238	"	"	"	"	"	"	
RGS-8	296.5	"	"	"	"	"	"	
RGS-2+2	242		"	"	"	"	"	
RGS-2+4	300.5		"	"	"	"	"	
RGS-2+6	359		"	"	"	"	"	
RGS-2+8	417.5		"	"	"	"	"	
RGS-4+4	359		"	"	"	"	"	
RGS-4+6	417.5		"	"	"	"	"	
RGS-4+8	476		"	"	"	"	"	
RGS-2+2	476		"	"	"	"	"	
RGS-2+2	534.5		"	"	"	"	"	
RGS-2+2	593		"	"	"	"	"	
RGS-2+2	232	140.5						<p>n = number of frames wide. Tolerance single frame: Height ± 1mm, Width ± 0,8mm. Material thickness is 10mm.</p> <p>All measurements are in millimetres.</p>
RGS-2+2	290.5	"						
RGS-2+2	349	"						
RGS-2+2	407.5	"						
RGS-4+4	349	"						
RGS-4+6	407.5	"						
RGS-4+8	466	"						
RGS-6+6	466	"						
RGS-6+8	524.5	"						
RGS-8+8	583	"						

Weights

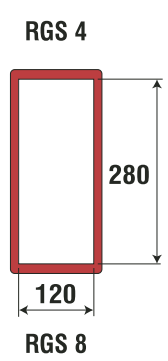
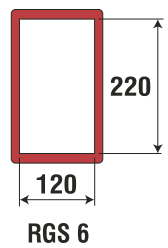
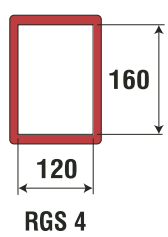
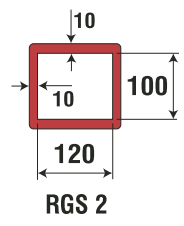

		Material	Frame Size / Combination	x1	x2	x3	x4	x5	x6
		Mild Steel EN10025 S235JRG2 BS 4360 gr.40		RGS-2	2.2	3.9	5.7	7.4	9.2
RGS-4	2.7			4.6	6.5	8.4	10.3	12.2	
RGS-6	3.2			5.4	7.6	9.8	12.0	14.2	
RGS-8	3.8			6.3	8.9	11.4	14.0	16.5	
RGS-2 + 2	3.6			8.1	11.9	15.7	19.5	23.3	
RGS-2 + 4	4.2			8.8	12.8	16.7	20.7	24.6	
RGS-2 + 6	4.8			9.5	13.6	17.8	21.9	26.0	
RGS-2 + 8	5.5			10.3	14.7	19.1	23.5	27.9	
RGS-4 + 4	4.8			9.5	13.6	17.8	21.9	26.0	
RGS-4 + 6	5.5			10.3	14.7	19.1	23.5	27.9	
RGS-4 + 8	5.9			11.1	15.8	20.5	25.1	29.8	
RGS-6 + 6	5.9			11.1	15.8	20.5	25.1	29.8	
RGS-6 + 8	6.5			12.0	17.0	22.1	27.1	32.1	
RGS-8 + 8	7.2			12.9	18.3	23.7	29.1	34.5	
Stainless Steel EN10088-1 1.4404 BS 970 gr.316				RGS-2	2.2	4.0	5.8	7.6	9.4
		RGS-4	2.8	4.7	6.7	8.6	10.6	12.6	
		RGS-6	3.3	5.5	7.8	10.1	12.3	14.5	
		RGS-8	3.9	6.5	9.1	11.7	14.3	16.9	
		RGS-2 + 2	3.7	8.3	12.2	16.1	20.0	23.9	
		RGS-2 + 4	4.3	9.0	13.1	17.1	21.2	25.2	
		RGS-2 + 6	4.9	9.7	14.0	18.2	22.5	26.7	
		RGS-2 + 8	5.6	10.6	15.1	19.6	24.1	28.6	
		RGS-4 + 4	4.9	9.7	14.0	18.2	22.5	26.7	
		RGS-4 + 6	5.6	10.6	15.1	19.6	24.1	28.6	
		RGS-4 + 8	6.0	11.4	16.2	21.0	25.8	30.6	
		RGS-6 + 6	6.0	11.4	16.2	21.0	25.8	30.6	
		RGS-6 + 8	6.7	12.3	17.5	22.6	27.8	32.9	
		RGS-8 + 8	7.4	13.2	18.8	24.3	29.9	35.4	
		Aluminium EN AW-6082 BS 1474 gr.6082		RGS-2	0.8	1.4	2.0	2.6	3.2
RGS-4	1.0			1.6	2.3	3.0	3.6	4.3	
RGS-6	1.1			1.9	2.7	3.4	4.2	5.0	
RGS-8	1.3			2.2	3.1	4.0	4.9	5.8	
RGS-2 + 2	1.3			2.8	4.2	5.5	6.9	8.2	
RGS-2 + 4	1.5			3.1	4.5	5.9	7.2	8.6	
RGS-2 + 6	1.7			3.3	4.8	6.2	7.7	9.1	
RGS-2 + 8	1.9			3.6	5.2	6.7	8.3	9.8	
RGS-4 + 4	1.7			3.3	4.8	6.2	7.7	9.1	
RGS-4 + 6	1.9			3.6	5.2	6.7	8.3	9.8	
RGS-4 + 8	2.1			3.9	5.5	7.2	8.8	10.4	
RGS-6 + 6	2.1			3.9	5.5	7.2	8.8	10.4	
RGS-6 + 8	2.3			4.2	6.0	7.7	9.5	11.2	
RGS-8 + 8	2.5	4.5	6.4	8.3	10.2	12.1			

Weight Chart In Kilograms

- The Company
- Why MCT Brattberg
- The Products
- Multiple Frames
- Planning the Packing Space
- Frames for Marine/Offshore
- Frames for Civil/Industry
- RGP Frames & Seals
- Blocks & Components
- Frame Installation Methods
- Packing Guides
- EMC Protection
- Deck & Bulkhead Glands
- SR Cable & Pipe Seals
- MSR Cable Glands
- X-Series Cable Transit
- Transit Planning Software

RGSC

RGSC is a frame with rounded corners, which reduces the risk of cracks forming in decks and bulkheads that are subjected to high stresses. Similar to the RGS frame, it is available in sizes 2, 4, 6 and 8. They may be combined vertically & horizontally to create multiple frames. Available in mild steel, stainless steel and aluminium.

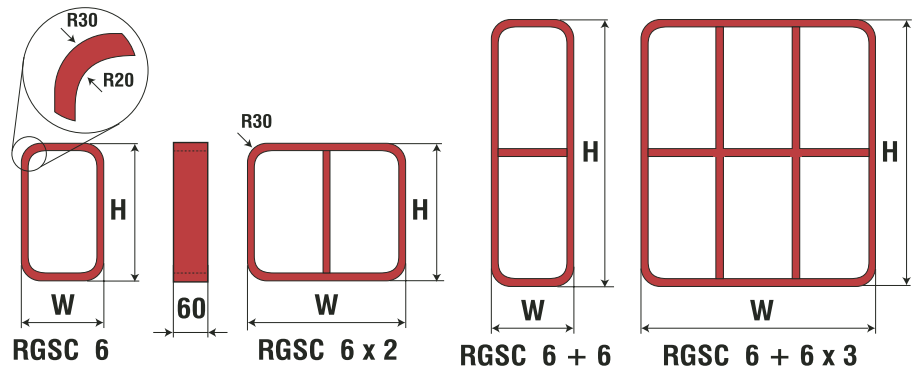
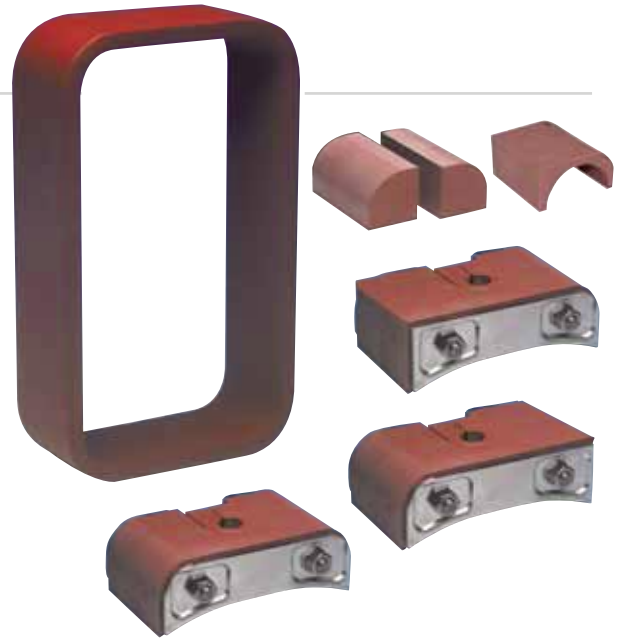

Size In mm								
Frame Size	(Height)	W (width) / Multiple Frames						
		x 1	x 2	x 3	x 4	x 5	x 6	x n
RGS-2	121	140.5	271	401.5	532	662.5	793	W = 10+ 130.5 x n
RGS-4	179.5	“	“	“	“	“	“	
RGS-6	238	“	“	“	“	“	“	
RGS-8	296.5	“	“	“	“	“	“	
RGS-2+2	242		“	“	“	“	“	
RGS-2+4	300.5		“	“	“	“	“	
RGS-2+6	359		“	“	“	“	“	
RGS-2+8	417.5		“	“	“	“	“	
RGS-4+4	359		“	“	“	“	“	
RGS-4+6	417.5		“	“	“	“	“	
RGS-4+8	476		“	“	“	“	“	
RGS-6+6	476		“	“	“	“	“	
RGS-6+8	534.5		“	“	“	“	“	
RGS-8+8	593		“	“	“	“	“	
RGS-2+2	232	140.5	n = number of frames wide. Tolerance single frame: Height ± 1mm, Width ± 0.8mm. Material thickness is 10mm. All measurements are in millimetres.					
RGS-2+4	290.5	“						
RGS-2+6	349	“						
RGS-2+8	407.5	“						
RGS-4+4	349	“						
RGS-4+6	407.5	“						
RGS-4+8	466	“						
RGS-6+6	466	“						
RGS-6+8	524.5	“						
RGSC-8+8	583	“						

The Company

Why MCT Brattberg

The Products

Multiple Frames

Planning the Packing Space

Frames for Marine/Offshore

Frames for Civil/Industry

RGP Frames & Seals

Blocks & Components

Frame Installation Methods

Packing Guides

EMC Protection

Deck & Bulkhead Glands

SR Cable & Pipe Seals

MSR Cable Glands

X-Series Cable Transit

Transit Planning Software

	Material	Frame Size / Combination	Weight Chart In Kilograms					
			x1	x2	x3	x4	x5	x6
<p>RGSC 2</p>	Mild Steel EN10025 S235JRG2 BS 4360 gr.40	RGSC-2	2.2	3.9	5.7	7.4	9.2	10.9
		RGSC-4	2.7	4.6	6.5	8.4	10.3	12.2
		RGSC-6	3.2	5.4	7.6	9.8	12.0	14.2
		RGSC-8	3.8	6.3	8.9	11.4	14.0	16.5
		RGSC-2 + 2	3.6	8.1	11.9	15.7	19.5	23.3
		RGSC-2 + 4	4.2	8.8	12.8	16.7	20.7	24.6
		RGSC-2 + 6	4.8	9.5	13.6	17.8	21.9	26.0
		RGSC-2 + 8	5.5	10.3	14.7	19.1	23.5	27.9
		RGSC-4 + 4	4.8	9.5	13.6	17.8	21.9	26.0
		RGSC-4 + 6	5.5	10.3	14.7	19.1	23.5	27.9
		RGSC-4 + 8	5.9	11.1	15.8	20.5	25.1	29.8
		RGSC-6 + 6	5.9	11.1	15.8	20.5	25.1	29.8
		RGSC-6 + 8	6.5	12.0	17.0	22.1	27.1	32.1
RGSC-8 + 8	7.2	12.9	18.3	23.7	29.1	34.5		
<p>RGSC 4</p>	Stainless Steel EN10088-1 1.4404 BS 970 gr.316	RGSC-2	2.2	4.0	5.8	7.6	9.4	11.2
		RGSC-4	2.8	4.7	6.7	8.6	10.6	12.6
		RGSC-6	3.3	5.5	7.8	10.0	12.3	14.5
		RGSC-8	3.9	6.5	9.1	11.7	14.3	16.9
		RGSC-2 + 2	3.7	8.3	12.2	16.1	20.0	23.9
		RGSC-2 + 4	4.3	9.0	13.1	17.1	21.2	25.2
		RGSC-2 + 6	4.9	9.7	14.0	18.2	22.5	26.7
		RGSC-2 + 8	5.6	10.6	15.1	19.6	24.1	28.6
		RGSC-4 + 4	4.9	9.7	14.0	18.2	22.5	26.7
		RGSC-4 + 6	5.6	10.6	15.1	19.6	24.1	28.6
		RGSC-4 + 8	6.0	11.4	16.2	21.0	25.8	30.6
		RGSC-6 + 6	6.0	11.4	16.2	21.0	25.8	30.6
		RGSC-6 + 8	6.7	12.3	17.5	22.6	27.8	32.9
RGSC-8 + 8	7.4	13.2	18.8	24.3	29.9	35.4		
<p>RGSC 6</p>	Aluminium EN AW-6082 BS 1474 gr.6082	RGSC-2	0.8	1.4	2.0	2.6	3.2	3.8
		RGSC-4	1.0	1.6	2.3	3.0	3.6	4.3
		RGSC-6	1.1	1.9	2.7	3.4	4.2	5.0
		RGSC-8	1.3	2.2	3.1	4.0	4.9	5.8
		RGSC-2 + 2	1.3	2.8	4.2	5.5	6.9	8.2
		RGSC-2 + 4	1.5	3.1	4.5	5.9	7.2	8.6
		RGSC-2 + 6	1.7	3.3	4.8	6.2	7.7	9.1
		RGSC-2 + 8	1.9	3.6	5.2	6.7	8.3	9.8
		RGSC-4 + 4	1.7	3.3	4.8	6.2	7.7	9.1
		RGSC-4 + 6	1.9	3.6	5.2	6.7	8.3	9.8
		RGSC-4 + 8	2.1	3.9	5.5	7.2	8.8	10.4
		RGSC-6 + 6	2.1	3.9	5.5	7.2	8.8	10.4
		RGSC-6 + 8	2.3	4.2	6.0	7.7	9.5	11.2
RGSC-8 + 8	2.5	4.5	6.4	8.3	10.2	12.1		
<p>RGSC 8</p>	Aluminium EN AW-6082 BS 1474 gr.6082	RGSC-2	0.8	1.4	2.0	2.6	3.2	3.8
		RGSC-4	1.0	1.6	2.3	3.0	3.6	4.3
		RGSC-6	1.1	1.9	2.7	3.4	4.2	5.0
		RGSC-8	1.3	2.2	3.1	4.0	4.9	5.8
		RGSC-2 + 2	1.3	2.8	4.2	5.5	6.9	8.2
		RGSC-2 + 4	1.5	3.1	4.5	5.9	7.2	8.6
		RGSC-2 + 6	1.7	3.3	4.8	6.2	7.7	9.1
		RGSC-2 + 8	1.9	3.6	5.2	6.7	8.3	9.8
		RGSC-4 + 4	1.7	3.3	4.8	6.2	7.7	9.1
		RGSC-4 + 6	1.9	3.6	5.2	6.7	8.3	9.8
		RGSC-4 + 8	2.1	3.9	5.5	7.2	8.8	10.4
		RGSC-6 + 6	2.1	3.9	5.5	7.2	8.8	10.4
		RGSC-6 + 8	2.3	4.2	6.0	7.7	9.5	11.2
RGSC-8 + 8	2.5	4.5	6.4	8.3	10.2	12.1		

RGSF/RGSFB RGSFO/RGSFBO With Removable End

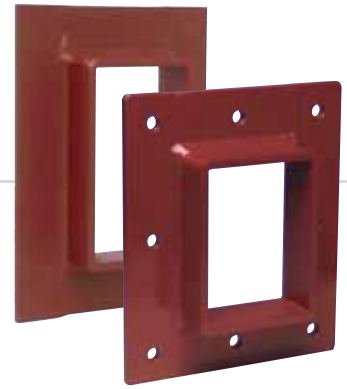

RGSF is a standard RGS frame with a flange that allows the frame to be welded over a hole which is slightly larger than the frame. RGSF frames are available in four standard sizes, 2, 4, 6 and 8, and has the internal measurements of the RGS, with a flange: 60mm wide and 10mm thick. They may be combined vertically & horizontally to create multiple frames. For installations where cables are already in place, specify RGSFO which has a removable end.

The RGSFB frame is similar to RGSF except that it is bolted to the deck or bulkhead. The bolted frames can be used in areas where hot working is prohibited, or when the stress level induced by welding is unacceptable. RGSFB frames are supplied in kit form, complete with drilled holes, nuts, bolts, washers and a sealing compound to be installed between the flange and the deck or bulkhead to ensure a gas-tight installation. For installations where cables are already in place, specify RGSFBO which has a removable end.

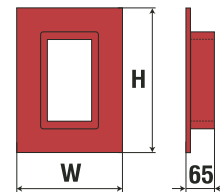

RGSF 6

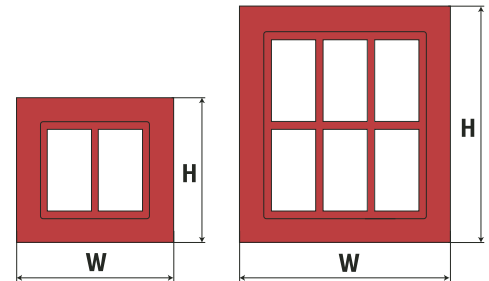

RGSF 6 x 2

RGSF 6 + 6 x 3

Size In mm								
Frame Size	(Height)	W (width) / Multiple Frames						
		x 1	x 2	x 3	x 4	x 5	x 6	x n
RGSF/B-2	241	260.5	391	521.5	652	782.5	913	W = 130+ 130.5 x n
RGSF/B-4	299.5	"	"	"	"	"	"	
RGSF/B-6	358	"	"	"	"	"	"	
RGSF/B-8	416.5	"	"	"	"	"	"	
RGSF/B-2+2	362	260.5	"	"	"	"	"	
RGSF/B-2+4	420.5		"	"	"	"	"	
RGSF/B-2+6	479		"	"	"	"	"	
RGSF/B-2+8	537.5		"	"	"	"	"	
RGSF/B-4+4	479		"	"	"	"	"	
RGSF/B-4+6	537.5		"	"	"	"	"	
RGSF/B-4+8	596		"	"	"	"	"	
RGSF/B-6+6	596		"	"	"	"	"	
RGSF/B-6+8	654.5		"	"	"	"	"	
RGSF/B-8+8	713		"	"	"	"	"	
RGSF/B-2+2	352	260.5						n = number of frames wide. Tolerance single frame: Height ± 1mm, Width ± 0.8mm. Material thickness is 10mm.
RGSF/B-2+4	410.5	"						
RGSF/B-2+6	469	"						
RGSF/B-2+8	527.5	"						
RGSF/B-4+4	469	"						
RGSF/B-4+6	527.5	"						
RGSF/B-4+8	586	"						
RGSF/B-6+6	586	"						
RGSF/B-6+8	644.5	"						
RGSF/B-8+8	703	"						

INTERNAL Dimensions Of 2, 4, 6 And 8 Transit Frames

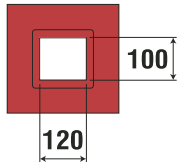

RGSF 2

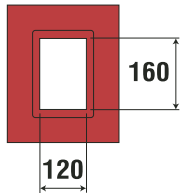

RGSF 4

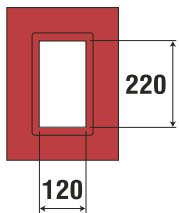

RGSF 6

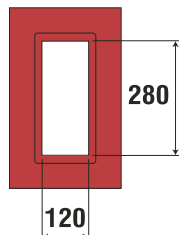

RGSF 8

Material	Frame Size / Combination	x1	x2	x3	x4	x5	x6
Mild Steel EN10025 S235JRG2 BS 4360 gr.40	2	5.9	8.9	11.8	14.8	17.8	20.7
	4	7.0	10.3	13.6	16.9	20.2	23.4
	6	8.0	11.5	15.1	18.6	22.1	25.6
	8	9.0	12.8	16.5	20.3	24.0	27.8
	2 + 2	8.4	13.9	19.0	24.0	29.1	34.1
	2 + 4	9.5	15.3	20.5	25.7	30.9	36.1
	2 + 6	10.6	16.5	21.9	27.2	32.6	37.9
	2 + 8	11.7	17.9	23.5	29.2	34.8	40.4
	4 + 4	10.6	16.5	21.9	27.2	32.6	37.9
	4 + 6	11.7	17.9	23.5	29.2	34.8	40.4
	4 + 8	12.8	19.2	25.1	31.0	36.9	42.8
	6 + 6	12.8	19.2	25.1	31.0	36.9	42.8
	6 + 8	13.9	20.6	26.9	33.1	39.4	45.6
8 + 8	15.0	22.1	28.7	35.4	42.0	48.6	
Stainless Steel EN10088-1 1.4404 BS 970 gr.316	2	6.1	9.1	12.1	15.2	18.2	21.2
	4	7.2	10.6	13.9	17.3	20.7	24.0
	6	8.2	11.8	15.4	19.0	22.7	26.3
	8	9.2	13.1	16.9	20.8	24.6	28.5
	2 + 2	8.6	14.3	19.5	24.7	29.8	35.0
	2 + 4	9.7	15.7	21.0	26.4	31.7	37.0
	2 + 6	10.9	16.9	22.4	27.9	33.4	38.9
	2 + 8	12.0	18.4	24.2	29.9	35.7	41.4
	4 + 4	10.9	16.9	22.4	27.9	33.4	38.9
	4 + 6	12.0	18.4	24.2	29.9	35.7	41.4
	4 + 8	13.1	19.7	25.8	31.8	37.9	43.9
	6 + 6	13.1	19.7	25.8	31.8	37.9	43.9
	6 + 8	14.3	21.1	27.5	33.9	40.3	46.7
8 + 8	15.4	22.7	29.5	36.3	43.0	49.8	
Aluminium EN AW-6082 BS 1474 gr.6082	2	2.1	3.1	4.1	5.2	6.2	7.3
	4	2.5	3.6	4.8	5.9	7.1	8.2
	6	2.8	4.0	5.3	6.5	7.7	9.0
	8	3.2	4.5	5.8	7.1	8.4	9.7
	2 + 2	2.9	4.9	6.7	8.4	10.2	11.9
	2 + 4	3.3	5.4	7.2	9.1	10.9	12.7
	2 + 6	3.7	5.8	7.7	9.6	11.4	13.3
	2 + 8	4.1	6.3	8.3	10.2	12.2	14.1
	4 + 4	3.7	5.8	7.7	9.6	11.4	13.3
	4 + 6	4.1	6.3	8.3	10.2	12.2	14.1
	4 + 8	4.5	6.7	8.8	10.9	12.9	15.0
	6 + 6	4.5	6.7	8.8	10.9	12.9	15.0
	6 + 8	4.9	7.2	9.4	11.6	13.7	15.9
8 + 8	5.3	7.7	10.0	12.4	14.7	17.0	

- The Company
- Why MCT Brattberg
- The Products
- Multiple Frames
- Planning the Packing Space
- Frames for Marine/Offshore
- Frames for Civil/Industry
- RGP Frames & Seals
- Blocks & Components
- Frame Installation Methods
- Packing Guides
- EMC Protection
- Deck & Bulkhead Glands
- SR Cable & Pipe Seals
- MSR Cable Glands
- X-Series Cable Transit
- Transit Planning Software

RGSK/RGSbth

RGSK is an extended RGS frame, with machined grooves for stayplates and compression plates. The material is 10mm thick on the ends and 12mm thick on the sides. RGSK is available in four standard sizes: 2, 4, 6 and 8.

The frame allows installation in positions where the transit needs to be elevated above possible contamination.

RGSbth is a double frame which is packed from both sides, enabling a pressure seal of up to 5 bar (test pressure) on either side of the penetration. Installations with this frame can be pressure tested using space between the two sets of blocks. They also conform to jet-fire rating.

The frame is 10mm thick on the top and bottom and 12mm thick on the sides. It is 200mm deep. Other dimensions are the same as for the RGS. RGSbth is available in four standard sizes: 2, 4, 6, and 8. They may be combined vertically & horizontally to create multiple frames.

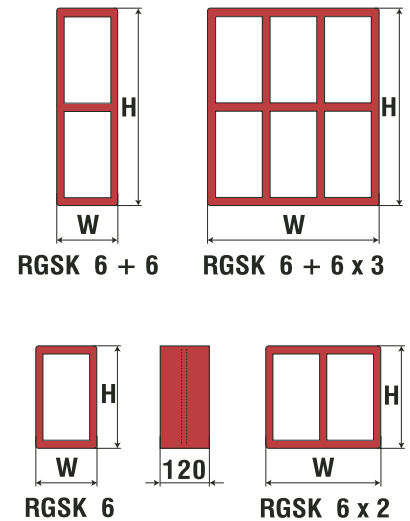
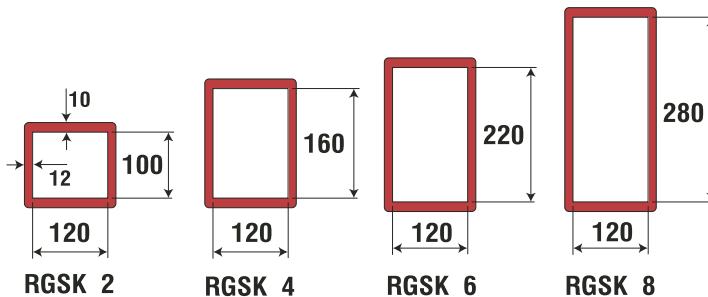

Size In mm								
Frame ize	(Height)	W (width) / Multiple Frames						
		x 1	x 2	x 3	x 4	x 5	x 6	x n
RGSK/RGS/btb-2	121	144.5	275	405.5	536	666.5	797	W = 14+
RGSK/RGS/btb-4	179.5	"	"	"	"	"	"	"
RGSK/RGS/btb-6	238	"	"	"	"	"	"	130.5 x n
RGSK/RGS/btb-8	296.5	"	"	"	"	"	"	"
RGSK/RGS/btb-2+2	232	"	"	"	"	"	"	"
RGSK/RGS/btb-2+4	290.5	"	"	"	"	"	"	"
RGSK/RGS/btb-2+6	349	"	"	"	"	"	"	"
RGSK/RGS/btb-2+8	407.5	"	"	"	"	"	"	"
RGSK/RGS/btb-4+4	349	"	"	"	"	"	"	"
RGSK/RGS/btb-4+6	407.5	"	"	"	"	"	"	"
RGSK/RGS/btb-4+8	466	"	"	"	"	"	"	"
RGSK/RGS/btb-6+6	466	"	"	"	"	"	"	"
RGSK/RGS/btb-6+8	524.5	"	"	"	"	"	"	"
RGSK/RGS/btb-8+8	583	"	"	"	"	"	"	"

Tolerance single frame:
Height ± 1mm, Width ± 0.8mm.
Material thickness is 10mm.

Weight Chart In Kilograms	Material	Frame Size / Combination	x1	x2	x3	x4	x5	x6
	Mild Steel EN10025 S235JRG2 BS 4360 gr.40	RGSK-2	4.7	7.7	10.7	13.7	16.7	19.7
		RGSK-4	6.0	9.3	12.6	15.9	19.2	22.5
		RGSK-6	7.3	10.9	14.5	18.2	21.8	25.4
		RGSK-8	8.7	12.5	16.4	20.4	24.3	28.2
		RGSK-2+2	7.8	11.9	16.1	20.4	24.6	28.8
		RGSK-2+4	9.2	13.6	18.1	22.6	27.1	31.6
		RGSK-2+6	10.6	15.2	20.0	24.8	29.5	34.3
		RGSK-2+8	11.9	16.9	22.0	27.0	32.1	37.1
		RGSK-4+4	10.6	15.2	20.0	24.8	29.5	34.3
		RGSK-4+6	11.9	16.9	22.0	27.0	32.1	37.1
		RGSK-4+8	13.2	18.4	23.7	29.1	34.4	39.7
		RGSK-6+6	13.2	18.4	23.7	29.1	34.4	39.7
	RGSK-6+8	14.5	20.0	25.5	31.0	36.5	42.5	
	RGSK-8+8	15.9	21.6	27.4	33.2	38.9	45.2	
	Stainless Steel EN10088-1 1.4404 BS 970 gr.316	RGSK-2	4.8	7.9	11.0	14.1	17.1	20.2
		RGSK-4	6.2	9.5	12.9	16.3	19.7	23.1
		RGSK-6	7.5	11.2	14.9	18.6	22.3	26.0
		RGSK-8	8.9	12.8	16.8	20.9	24.9	28.9
		RGSK-2+2	8.0	12.2	16.5	20.9	25.2	29.5
		RGSK-2+4	9.4	13.9	18.5	23.2	27.8	32.4
		RGSK-2+6	10.9	15.6	20.5	25.4	30.3	35.2
		RGSK-2+8	12.2	17.3	22.5	27.7	32.8	38.0
		RGSK-4+4	10.9	15.6	20.5	25.4	30.3	35.2
		RGSK-4+6	12.2	17.3	22.5	27.7	32.8	38.0
		RGSK-4+8	13.5	18.9	24.4	29.8	35.3	40.7
		RGSK-6+6	13.5	18.9	24.4	29.8	35.3	40.7
	RGSK-6+8	14.9	20.5	26.3	32.1	37.8	43.6	
	RGSK-8+8	16.3	22.1	28.2	34.2	40.3	46.3	
	Aluminium EN AW-6082 BS 1474 gr.6082	RGSK-2	1.7	2.7	3.7	4.8	5.8	6.8
		RGSK-4	2.1	3.3	4.5	5.6	6.8	7.9
		RGSK-6	2.6	3.8	5.1	6.4	7.6	8.9
		RGSK-8	3.1	4.4	5.8	7.2	8.5	9.9
		RGSK-2+2	2.7	4.2	5.7	7.2	8.6	10.1
		RGSK-2+4	3.2	4.8	6.4	8.0	9.5	11.1
		RGSK-2+6	3.7	5.3	7.0	8.7	10.3	12.0
		RGSK-2+8	4.2	5.9	7.7	9.5	11.2	13.0
		RGSK-4+4	3.7	5.3	7.0	8.7	10.3	12.0
		RGSK-4+6	4.2	5.9	7.7	9.5	11.2	13.0
		RGSK-4+8	4.6	6.4	8.3	10.2	12.0	13.9
		RGSK-6+6	4.6	6.4	8.3	10.2	12.0	13.9
	RGSK-6+8	5.1	7.0	9.0	11.0	12.9	14.9	
	RGSK-8+8	5.6	7.6	9.7	11.7	13.8	15.8	

Size	x1	x2	x3	x4	x5	x6
2	7.9	13.0	18.4	23.7	29.1	34.4
4	10.1	15.8	21.7	27.6	33.5	39.4
6	12.4	18.6	25.1	31.5	38.0	44.4
8	14.5	21.2	28.2	35.2	42.2	49.2
2+2	13.5	20.9	28.5	36.1	43.7	51.3
2+4	15.3	23.3	31.5	39.7	47.8	56.0
2+6	17.8	26.3	35.0	43.7	52.4	61.1
2+8	20.0	29.1	38.4	47.7	56.9	66.2
4+4	17.8	26.3	35.0	43.7	52.4	61.1
4+6	20.0	29.1	38.4	47.7	56.9	66.2
4+8	22.3	31.9	41.7	51.5	61.3	71.1
6+6	22.3	31.9	41.7	51.5	61.3	71.1
6+8	24.5	34.7	45.1	55.5	65.8	76.2
8+8	26.6	37.3	48.2	59.2	70.1	81.0
2	8.1	13.3	18.8	24.3	29.8	35.3
4	10.4	16.2	22.3	28.3	34.4	40.4
6	12.7	19.1	25.7	32.3	38.9	45.5
8	14.9	21.7	28.9	36.1	43.2	50.4
2+2	13.8	21.4	29.2	37.0	44.8	52.6
2+4	15.7	23.9	32.3	40.7	49.0	57.4
2+6	18.3	27.0	35.9	44.8	53.7	62.6
2+8	20.5	29.8	39.3	48.9	58.4	67.9
4+4	18.3	27.0	35.9	44.8	53.7	62.6
4+6	20.5	29.8	39.3	48.9	58.4	67.9
4+8	22.9	32.7	42.8	52.8	62.9	72.9
6+6	22.9	32.7	42.8	52.8	62.9	72.9
6+8	25.1	35.6	46.1	56.9	67.5	78.1
8+8	27.3	38.2	49.4	60.6	71.8	83.0
2	2.8	4.6	6.5	8.3	10.2	12.0
4	3.5	5.5	7.6	9.7	11.7	13.8
6	4.3	6.5	8.8	11.0	13.3	15.5
8	5.1	7.4	9.9	12.3	14.8	17.2
2+2	4.7	7.3	10.0	12.7	15.3	18.0
2+4	5.4	8.2	11.1	13.9	16.8	19.6
2+6	6.2	9.2	12.3	15.3	18.4	21.4
2+8	7.0	10.2	13.5	16.7	20.0	23.2
4+4	6.2	9.2	12.3	15.3	18.4	21.4
4+6	7.0	10.2	13.5	16.7	20.0	23.2
4+8	7.8	11.2	14.6	18.1	21.5	24.9
6+6	7.8	11.2	14.6	18.1	21.5	24.9
6+8	8.6	12.2	15.8	19.5	23.1	26.7
8+8	9.3	13.1	16.9	20.8	24.6	28.4

RGB/RGBO With Removable End

RGB is a frame for casting or bolting to the wall/floor structure. It has a standard internal width of 120mm and is 60mm deep, available in four standard sizes, 2, 4, 6 & 8. The frame is manufactured 60 x 60 x 6mm angle.

For installations where cables are already in place specify the RGBO frame which has a removable end.

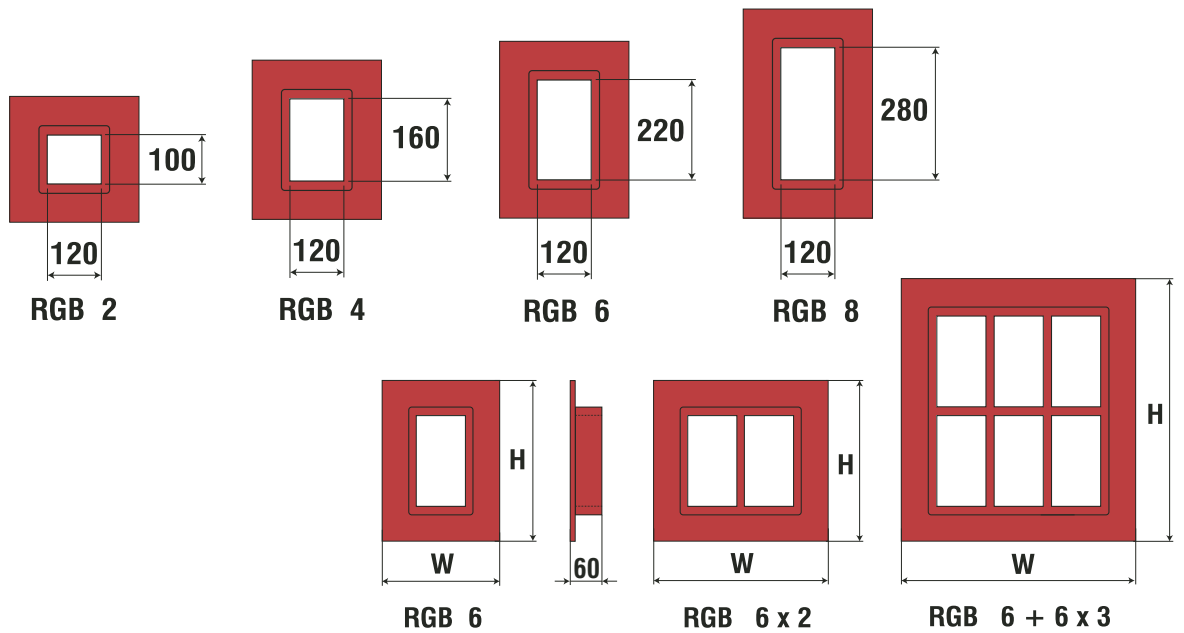

Size In mm								
Frame Size	(Height)	W (width) / Multiple Frames						
		x 1	x 2	x 3	x 4	x 5	x 6	x n
RGB-2	221	240.5	371	501.5	632	762.5	893	W = 110+ 130.5 x n
RGB-4	279.5	"	"	"	"	"	"	
RGB-6	338	"	"	"	"	"	"	
RGB-8	396.5	"	"	"	"	"	"	
RGB-2+2	332	"	"	"	"	"	"	
RGB-2+4	390.5	"	"	"	"	"	"	
RGB-2+6	449	"	"	"	"	"	"	
RGB-2+8	507.5	"	"	"	"	"	"	
RGB-4+4	449	"	"	"	"	"	"	
RGB-4+6	507.5	"	"	"	"	"	"	
RGB-4+8	566	"	"	"	"	"	"	
RGB-6+6	566	"	"	"	"	"	"	
RGB-6+8	624.5	"	"	"	"	"	"	
RGB-8+8	683	"	"	"	"	"	"	

n = number of frames in width.

Mild Steel

EN10025 S235JRG2
BS 4360 gr.40

Stainless Steel

EN10088-1 1.4404
BS 970 gr.316

Aluminium

EN AW-6082
BS 1474 gr.6082

RGG/RGGO With Removable End

RGG is a standard frame designed for plaster board or composite walls. It consists of two parts: a steel frame and a counter frame which neatly closes and seals the cut opening. Both frames are pre-drilled. RGG has the same dimensions as RGB.

The counter frame is available in three different depths to fit different wall thickness, see table below.

For installations where cables already are in place select the RGGO frame which has a removable end.



Wall Thickness (mm)		
Counter Frame/type	Min	Max
1	80	110
2	110	150
3	150	190

RGB/RGBO 180, 240 & 360 pipe transits

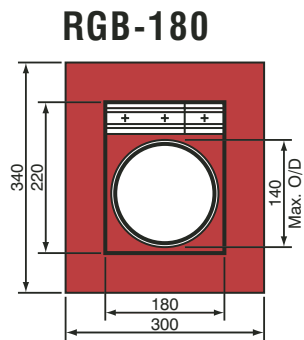

RGB-180

Transit
RGB-180
RGBO-180

Compression
Presswedge
1 x PTG-120 +
1 x PTG-60

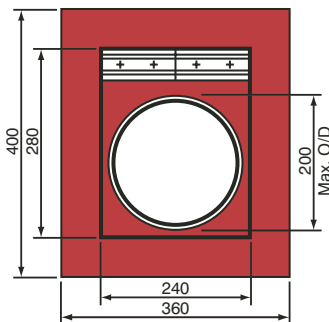

RGB-240

Transit
RGB-240
RGBO-240

Compression
Presswedge
2 x PTG-120

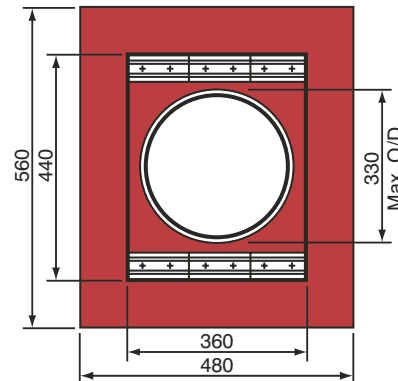

RGB-360

Transit
RGB-360
RGBO-360

Compression
Presswedge
6 x PTG-120

RGB 1, 3, & 5

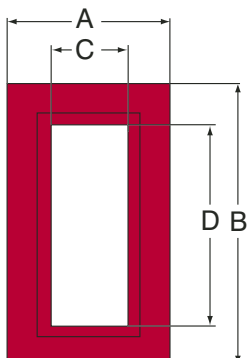

Frame Size	Dimensions			
	A	B	C	D
RGB1	180	221	60	100
RGB3	180	279.5	60	160
RGB5	180	338	60	220

- The Company
- Why MCT Brattberg
- The Products
- Multiple Frames
- Planning the Packing Space
- Frames for Marine/Offshore
- Frames for Civil/Industry
- RGP Frames & Seals
- Blocks & Components
- Frame Installation Methods
- Packing Guides
- EMC Protection
- Deck & Bulkhead Glands
- SR Cable & Pipe Seals
- MSR Cable Glands
- X-Series Cable Transit
- Transit Planning Software

Sleeves

The sleeve, is available in seven sizes, for welding, casting or bolting to the structure.

The standard materials are mild steel, stainless steel and aluminium.

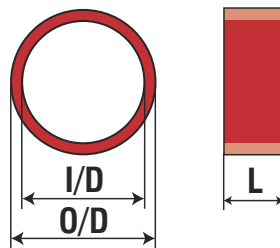

Type S Without Flange				
Type/size	O/D mm	I/D mm	L mm	Weight
S 50	63	51	70	0.6
S 70	83	71	70	0.8
S 100	114	102	70	1.1
S 125	140	128	70	1.4
S 150	164	152	82	1.9
S 200	214	202	82	2.5
S 300	316	302	85	4.5

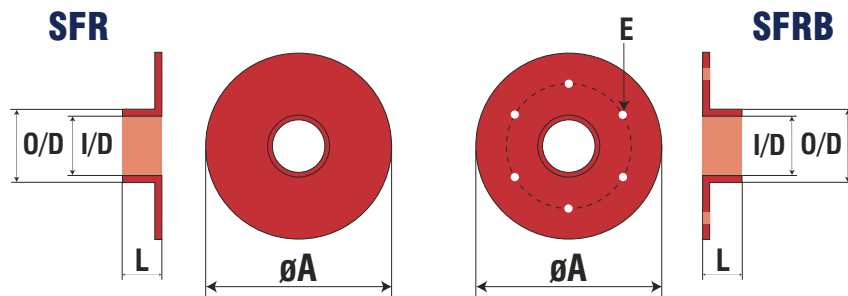

Type SFR With Round Flange							
Type/size	O/D mm	I/D mm	A mm	L mm	E mm	No. Of Holes	Weight kg
SFR 50	63	51	145	73	9	4	1.2
SFR 70	83	71	185	74	9	4	2.1
SFR 100	114	102	215	74	9	4	2.7
SFR 125	140	128	240	74	9	4	4.0
SFR 150	164	152	264	86	11	6	4.0
SFR 200	214	202	315	86	11	6	5.1
SFR 300	316	302	398	89	11	12	7.3

RGP – RGPO

RGP is a Lycron frame for assembly in sleeves, diamond drilled or cast holes. It is available in seven sizes and is packed with standard MCT insert blocks. The metal parts are available in galvanised or stainless steel.

RGPO is a Lycron frame with open sides intended for installation in holes where cables have already been installed.



Frame Size	Weight In kgs	Packing Space	Length x Diameter	Internal Hole Diameter
RGP 50	0.2	20	50 72	50.5 + 1.5 - 0
RGP 70	0.4	40	70 72	70.5 + 1.5 - 0
RGP 100	0.7	60	100 80	100.5 + 1.5 - 0
RGP 125	1.0	80	125 80	125.5 + 1.5 - 0
RGP 150	1.8	90	150 80	150.5 + 1.5 - 0
RGP 200	2.9	120	200 80	200.5 + 1.5 - 0
RGP 300	7.5	180	300 80	300.5 + 1.5 - 0

- The Company
- Why MCT Brattberg
- The Products
- Multiple Frames
- Planning the Packing Space
- Frames for Marine/Offshore
- Frames for Civil/Industry
- RGP Frames & Seals**
- Blocks & Components
- Frame Installation Methods
- Packing Guides
- EMC Protection
- Deck & Bulkhead Glands
- SR Cable & Pipe Seals
- MSR Cable Glands
- X-Series Cable Transit
- Transit Planning Software

Insert Blocks

Our range of Insert Blocks seal cables between 4 and 100mm in diameter. It is important that the insert block is the right size, with respect to the cable, to ensure a proper seal.

Measure the cable diameters carefully and select insert blocks according to the table.

Blocks are referred to by their width (A) and hole diameter (B). Thus a block with a width of 15mm and a hole diameter of 4mm is referred to as 15/4.

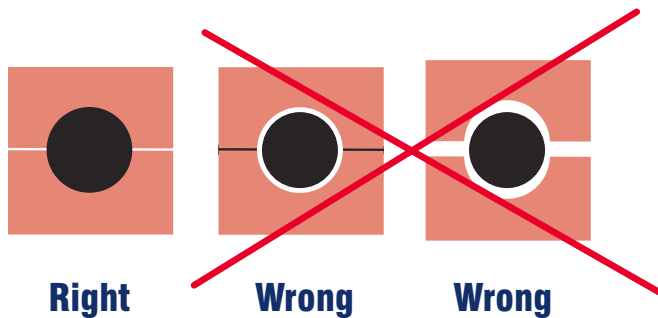
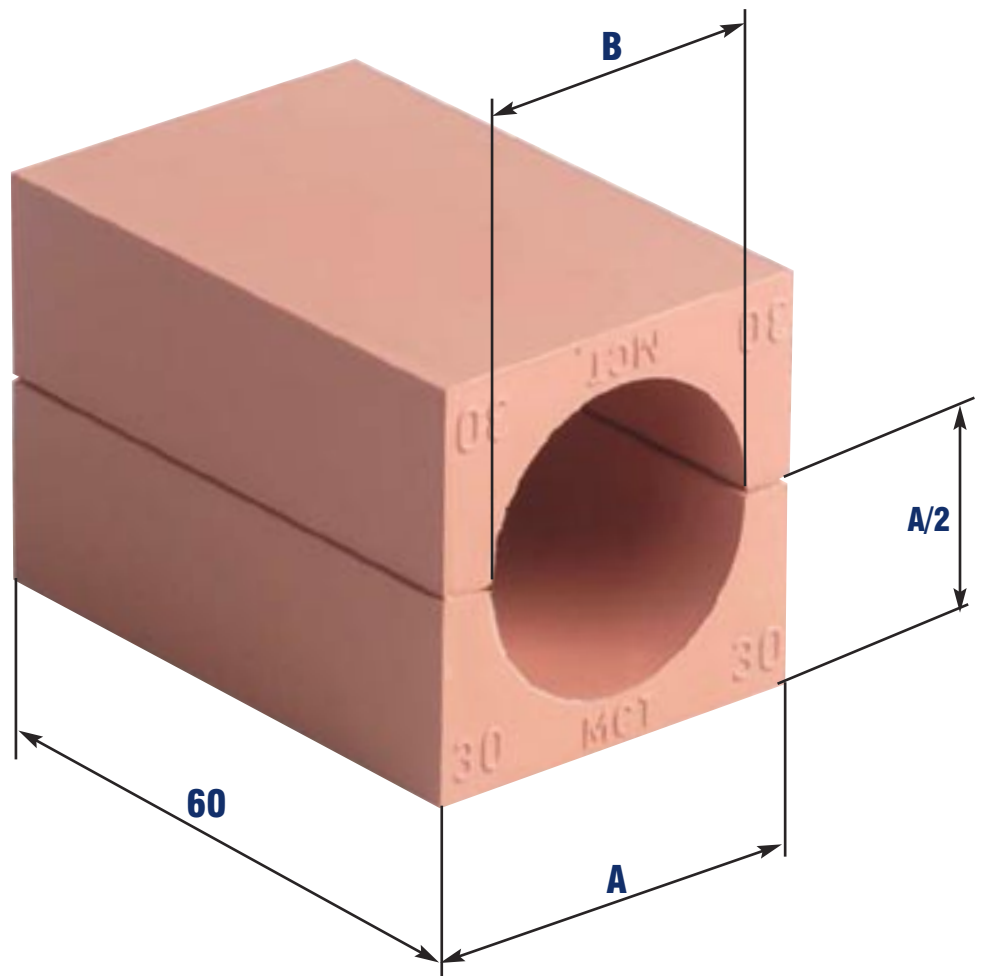

Cable/ Pipe Diam.mm	A							B
	15	20	30	40	60	90	120	
3.5 - 4.5	15/4	20/4						4
4.5 - 5.5	15/5	20/5						5
5.5 - 6.5	15/6	20/6						6
6.5 - 7.5	15/7	20/7						7
7.5 - 8.5	15/8	20/8						8
8.5 - 9.5	15/9	20/9						9
9.5 - 10.5		20/10						10
10.5 - 11.5		20/11						11
11.5 - 12.5		20/12	30/12					12
12.5 - 13.5		20/13	30/13					13
13.5 - 14.5		20/14	30/14					14
14.5 - 15.5		20/15	30/15					15
15.5 - 16.5		20/16	30/16					16
16.5 - 17.5			30/17					17
17.5 - 18.5			30/18					18
18.5 - 19.5			30/19					19
19.5 - 20.5			30/20					20
20.5 - 21.5			30/21					21
21.5 - 22.5			30/22	40/22				22
22.5 - 23.5			30/23	40/22				23
23.5 - 24.5			30/24	40/24				24
23.5 - 25.5				40/24				24
25.5 - 27.5				40/26				26
27.5 - 29.5				40/28				28
29.5 - 31.5				40/30				30
31.5 - 33.5				40/32	60/32			32
33.5 - 35.5				40/34	60/34			34
35.5 - 37.5					60/36			36
37.5 - 39.5					60/38			38
39.5 - 41.5					60/40			40
41.5 - 43.5					60/42			42
43.5 - 45.5					60/44			44
45.5 - 47.5					60/46			46
47.5 - 49.5					60/48			48
49.5 - 51.5					60/50			50
51.5 - 53.5					60/52			52
53.5 - 55.5					60/54			54

Weight In Grams						
15	20	30	40	60	90	120
10	18					
10	18					
10	17					
10	17					
9	16					
8	15					
	14					
	13					
	13	36				
	12	36				
	11	35				
	10	34				
	9	33				
		31				
		30				
		28				
		27				
		25				
		24	57			
		22	57			
		21	54			
			54			
			50			
			47			
			42			
			37	131		
			32	127		
				122		
				116		
				110		
				104		
				98		
				91		
				84		
				77		
				61		
				59		

Insert Blocks For Cables/pipes 49.5 - 69.5 Diameter Now Only Available In Addblock Range (see page 32).

69.5 - 71.5					90/70		70
71.5 - 73.5						120/72	72
73.5 - 75.5						120/74	74
75.5 - 77.5						120/76	76
77.5 - 79.5						120/78	78
79.5 - 81.5						120/80	80
81.5 - 83.5						120/82	82
83.5 - 85.5						120/84	84
85.5 - 87.5						120/86	86
87.5 - 89.5						120/88	88
89.5 - 91.5						120/90	90
91.5 - 93.5						120/92	92
93.5 - 95.5						120/94	94
95.5 - 97.5						120/96	96
97.5 - 99.5						120/98	98
99.5 - 101.5						120/100	100

					204		
							494
							485
							472
							462
							448
							437
							425
							415
							403
							385
							368
							360
							351
							332
							313

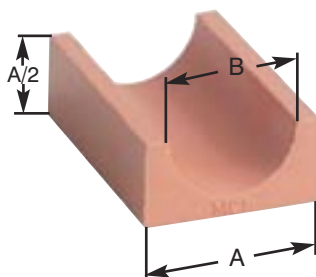

NOTE: Insert blocks are supplied in halves. Two insert blocks require to seal each cable/pipe.

- The Company
- Why MCT Brattberg
- The Products
- Multiple Frames
- Planning the Packing Space
- Frames for Marine/Offshore
- Frames for Civil/Industry
- RGP Frames & Seals
- Blocks & Components**
- Frame Installation Methods
- Packing Guides
- EMC Protection
- Deck & Bulkhead Glands
- SR Cable & Pipe Seals
- MSR Cable Glands
- X-Series Cable Transit
- Transit Planning Software

AddBlocks

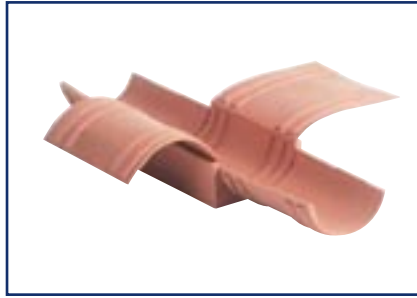

The AddBlock comes complete with inserts to give five different block sizes.

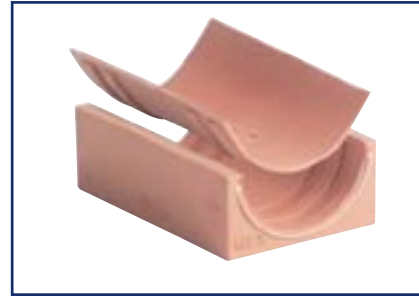

Inserts should be removed and fitted into the main block to give the required diameter.

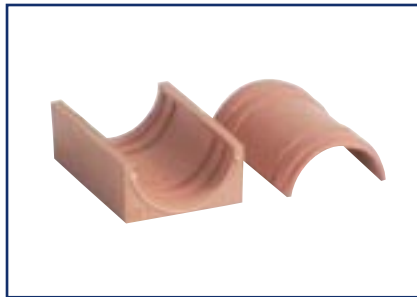

The unique locaters not only provide a secure anchor for the inserts, they also allow the removal and replacement to give the required diameter.

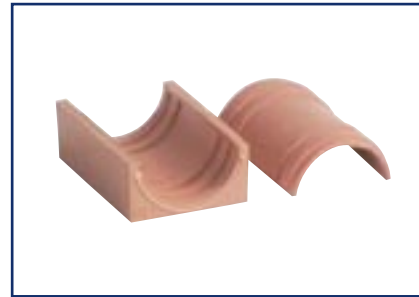

Inserts are marked with a diameter. Select the required diameter and fit into the main block.

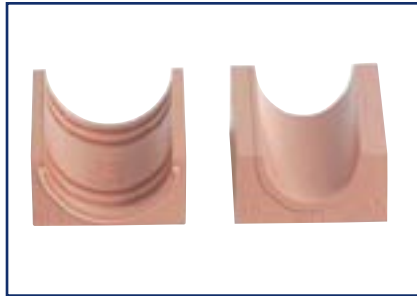

The complete block provides a quality, inspectable and truly flexible Insert Block.

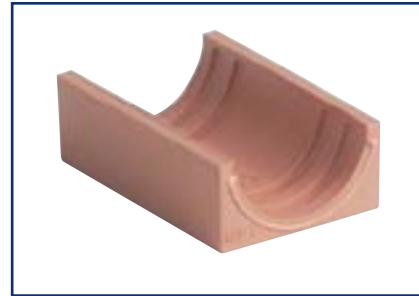

All insert sheets may be removed to give the largest sized diameter.

Cable Or Pipe Diameter (mm)	Block Reference	Weight In Grams / Half
3.5 - 8.5	20/4 - 8	23
8.5 - 13.5	20/9 - 13	24
13.5 - 18.5	30/14 - 18	46
18.5 - 23.5	30/19 - 23	43
23.5 - 28.5	40/24 - 28	71
28.5 - 33.5	40/29 - 33	63
33.5 - 38.5	60/34 - 38	150
38.5 - 43.5	60/39 - 43	139
43.5 - 49.5	60/44 - 48	126
49.5 - 59.5	90/50 - 58	348
59.5 - 69.5	90/60 - 68	321

The AddBlock is available in eleven module sizes, each size giving 5 adjustable diameters and a total of 55 inspectable inserts.

Insert Blocks are supplied in halves. Two Insert Blocks required to seal pipe/cable.

Plugs & Wraps



P20/8
Plug 8mm dia.
Fits AddBlock 20/4-8



P20/8
Plug 8mm dia.
With wrap-around casing
W-20-8/13
Fits AddBlock 20/9-13



P30/18
Plug 18mm diam.
Fits AddBlock 30/14-18



P30/18
Plug 18mm dia.
With wrap-around casing
W-30-18/23
Fits AddBlock 30/19-23



P40/28
Plug 28mm diam.
Fits AddBlock 40/24-28



P40/28
Plug 28mm dia. With
wrap-around casing
W-40-28/33
Fits AddBlock 40/29-33



P60/38
Plug 38mm dia. Fits in AddBlock 60/34-38



P60/38
Plug 38mm dia.
With wrap-around casing
W-60-38/43
Fits in AddBlock 60/39-43
With additional casing
W-60-43/48
Fits in AddBlock 60/44-48



AddBlock/Plug & Wrap

Plugs and wraps are used to convert an AddBlock into a Spare Block

- The Company
- Why MCT Brattberg
- The Products
- Multiple Frames
- Planning the Packing Space
- Frames for Marine/Offshore
- Frames for Civil/Industry
- RGP Frames & Seals
- Blocks & Components**
- Frame Installation Methods
- Packing Guides
- EMC Protection
- Deck & Bulkhead Glands
- SR Cable & Pipe Seals
- MSR Cable Glands
- X-Series Cable Transit
- Transit Planning Software

Spare Blocks

The unused space in the frame is filled with solid spare blocks. Using the spare blocks allows the option of fitting new cable in the future. They have the designation A/0. Blocks are referred to by their width (A), followed by the designation /0 (indicating solid).

A block with a width and height of 15mm is referred to as 15/0.

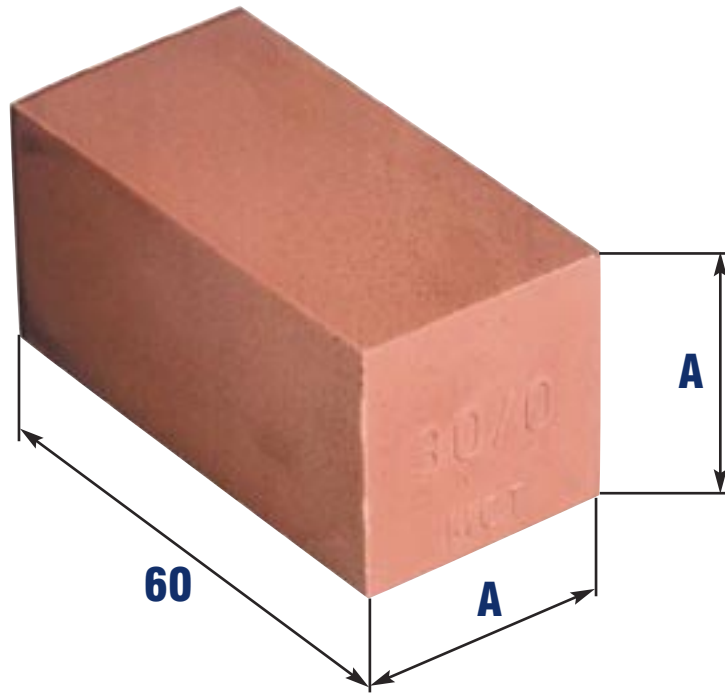

Spare Blocks		
Block Size Width (A) = Height (A)	Block Designation	Weight Grams
5 x 5 <i>Only in strips of 24 pcs</i>	24 x 5/0	58
10 x 10 <i>Only in strips of 12 pcs</i>	12 x 10/0	113
15 x 15	15/0	20
20 x 20	20/0	38
30 x 30	30/0	84
40 x 40	40/0	150
60 x 60	60/0	338
90 x 90	90/0	766
120 x 120	120/0	1374
180 x 180	180/0	2990

U-Blocks

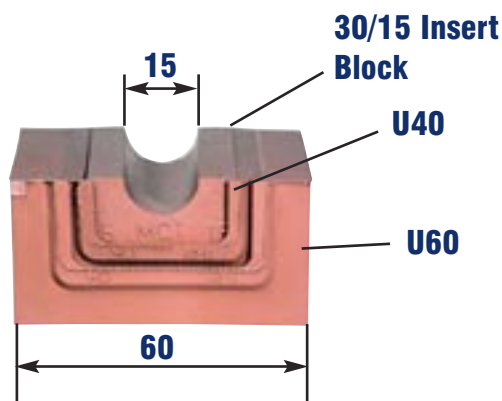

The U-Block is used to convert the external dimensions of Insert Blocks, AddBlocks and Spare Blocks to the next modular size.

For example a 30/15 Insert Block can be enlarged by placing it into a U40 and a U60, giving the new size of 60/15.

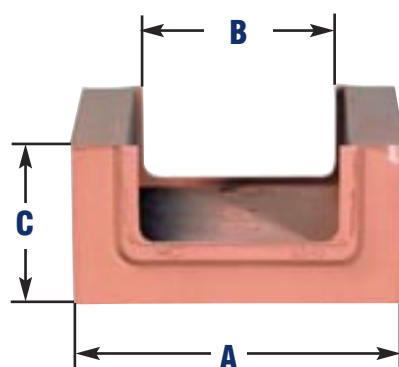
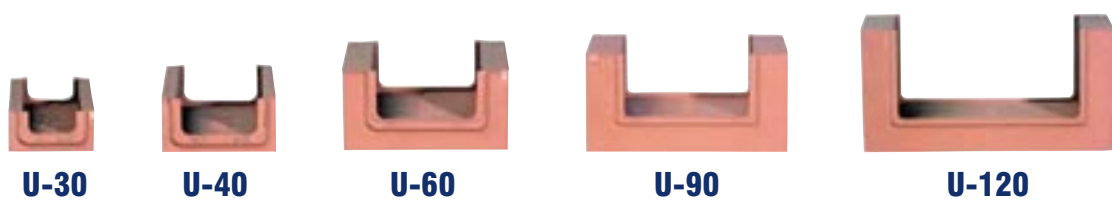

Size	A	B	C
U30	30	20	15
U40	40	30	20
U60	60	40	30
U90	90	60	45
U120	120	90	60

U-Block Combinations

By using the U-Blocks it is possible to increase the range of Spare Blocks. Starting with a 20/0 and the full range of U-Blocks you can convert the following.

U-Blocks are supplied in halves. Two blocks required to increase external dimensions.

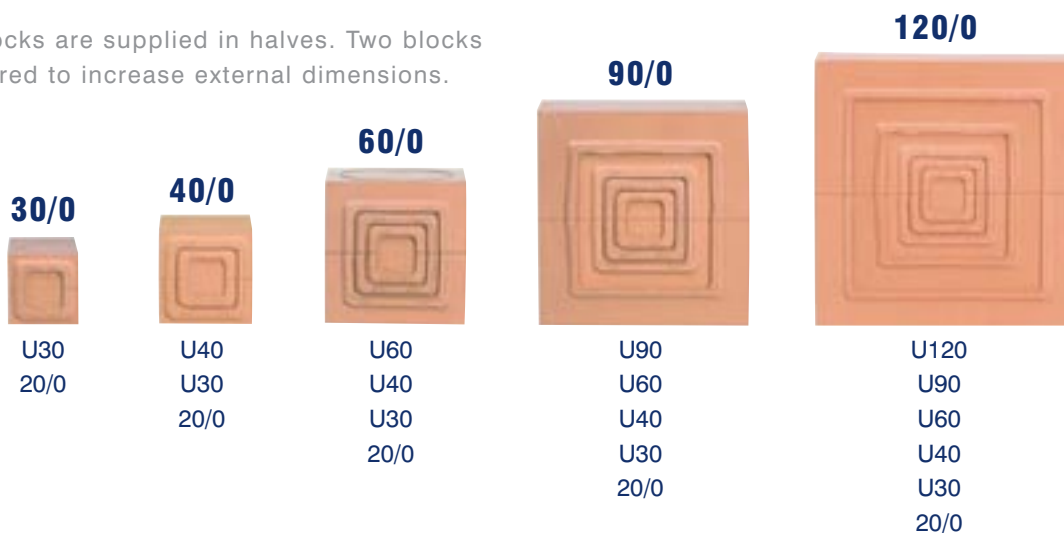

- The Company
- Why MCT Brattberg
- The Products
- Multiple Frames
- Planning the Packing Space
- Frames for Marine/Offshore
- Frames for Civil/Industry
- RGP Frames & Seals
- Blocks & Components**
- Frame Installation Methods
- Packing Guides
- EMC Protection
- Deck & Bulkhead Glands
- SR Cable & Pipe Seals
- MSR Cable Glands
- X-Series Cable Transit
- Transit Planning Software

Components

Stayplate

To be placed between each row of blocks. Stayplates make installation simple, increase stability and anchor blocks within the frame.

Stayplates are available in stainless steel, aluminium or brass.



Compression Plate

Inserted above the top row of blocks. The bolt is tightened to compress the system enabling installation of the STG endpacking. Manufactured from GRP, glassfibre reinforced polyester.

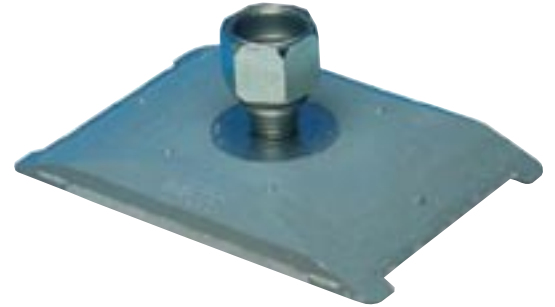

STG-Endpacking

Installed between compression plate and the top of the frame, completing the seal. Manufactured from Lycron with galvanized mild steel or stainless steel fittings.



PTG-Presswedge

Used as an alternative to the compression plate and STG Endpacking can also be placed anywhere in the frame. Manufactured from Lycron, with galvanized mild steel or stainless steel fittings.

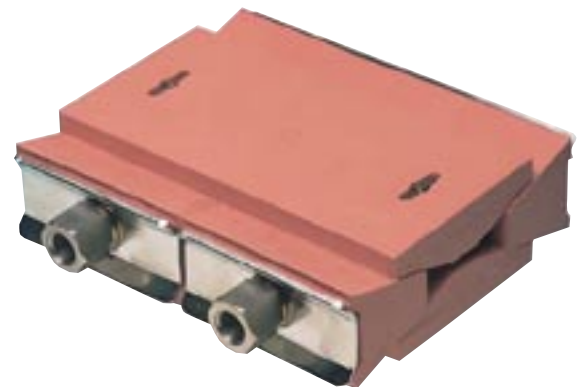

Weight In Kilograms			
STG	PTG	Compression Plate	Stayplate
0,6	0,82	0,24	0,13

Accessories

Lubricant

For Pressure Tight Installation



Packing Tool

Holds Cable/pipes During Partial Installations



Block Selector

For Cable/pipe Measurement



End Packer Puller

For Re-entry Into System



Ring Spanner

For End Packer & RGP Installation



Quick release Spanner

For Compression Plate Installation



Cable Separator

Support Cables During Installation



Blanking Plate

Seals Frame Prior To Block Installation



The Company

Why MCT Brattberg

The Products

Multiple Frames

Planning the Packing Space

Frames for Marine/Offshore

Frames for Civil/Industry

RGP Frames & Seals

Blocks & Components

Frame Installation Methods

Packing Guides

EMC Protection

Deck & Bulkhead Glands

SR Cable & Pipe Seals

MSR Cable Glands

X-Series Cable Transit

Transit Planning Software

Welding Instructions

Welding Method

Shielded metal arc welding (SMAW), Flux Core Arc Welding (FCAW)/

Welders Qualification

Welders to be qualified according to AWS D1.1 latest edition.

Consumable SMAW (AWS7016, AWS7018) FCAW(AWSE-71-T5)

Consumable to be handled and treated according to manufacturers recommendation.

Preparation And Fit

The prepared joint and surrounding areas shall be clean and free from moisture, oil, grease, oxides or any protective coating except weldable primers.

Maximum allowed root gap for fillet welds is 2mm (see fig 1).

Preheat And Interpass Temperature

To avoid hydrogen cracking, joints must be pre-heated to the temperature shown in the table below.

The minimum preheat temperature must be established for a minimum of 75mm on either side of the joint.

The inter-pass temperature must not exceed 250°C.

FIG 1:
maximum allowable
root gap for fillet joint

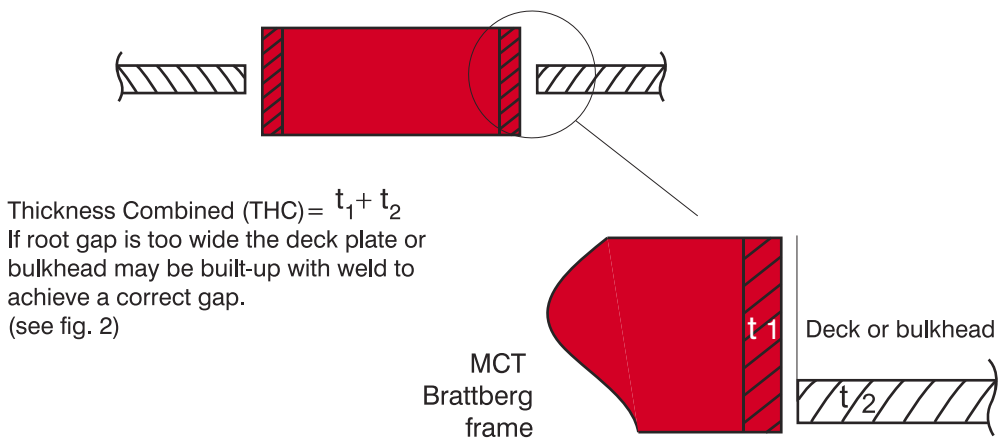
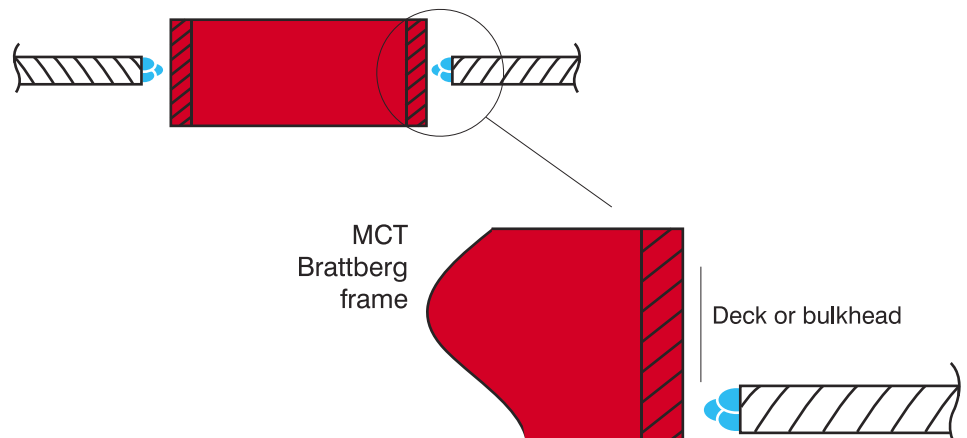

FIG 2:
Build-up of
fillet joint.



NOTE! Weld build-up on the frame is not recommended as it may cause distortion.

Welding Sequence

Welding to be performed according to fig.3 & 4.
Weld pass 3 is not to be started until welds 1 & 2 are completed.

FIG 3:

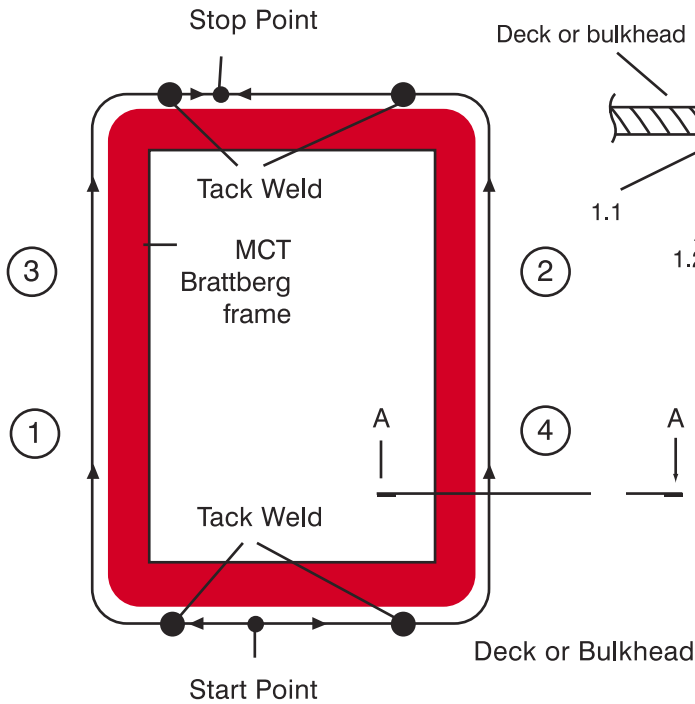
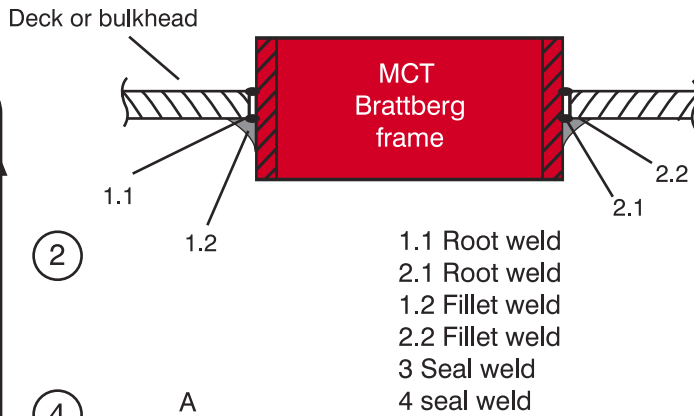

FIG 4:
Welding sequence



- 1.1 Root weld
- 2.1 Root weld
- 1.2 Fillet weld
- 2.2 Fillet weld
- 3 Seal weld
- 4 seal weld

Weld Size

Fillet weld size (throat thickness) is to be 0.5 x plate thickness of the bulkhead or deck plate (THD). However fillet weld size is not to be greater than 0.7 x frame plate thickness (THF). See fig 5.

Thus **(a)**
0.5 x THD 0.7 x THF

FIG 5:
Fillet weld size

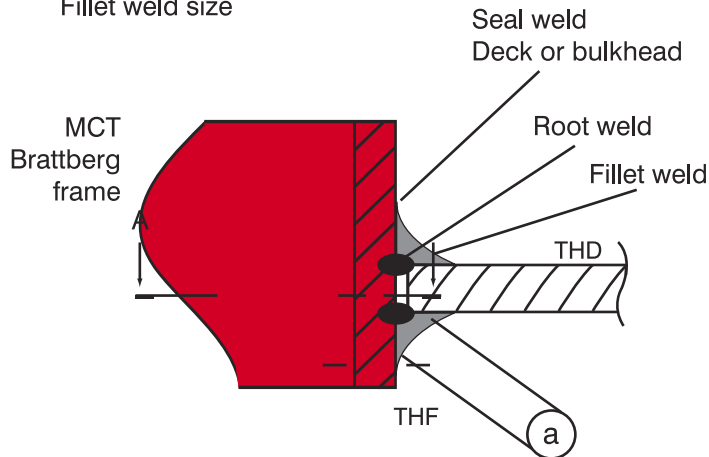

(a) = Fillet size (throat thickness)
THD = Thickness Deck plate
THF = Thickness Frame plate

NOTE! Multi-passwelding is required if **(a)** 5mm

- The Company
- Why MCT Brattberg
- The Products
- Multiple Frames
- Planning the Packing Space
- Frames for Marine/Offshore
- Frames for Civil/Industry
- RGP Frames & Seals
- Blocks & Components
- Frame Installation Methods**
- Packing Guides
- EMC Protection
- Deck & Bulkhead Glands
- SR Cable & Pipe Seals
- MSR Cable Glands
- X-Series Cable Transit
- Transit Planning Software

Civil Installation Methods

RGB

RGB frames can be cast directly into concrete walls or floors. Alternatively the frames can be cast into a block that is built in later. When the demands for fire safety are extremely high, frames can be mounted back-to-back.

For installation of the stayplate and compression plate, there must be 5mm of clearance between the inside of the frame and the edge of the cast hole. MCT Brattberg's expanded polystyrene moulds are available and provide the necessary clearance.

RGB and RGBO frames can be supplied with fixing holes. Silicon sealant should be used between the frame and the wall to provide a gasket seal.



MCT Brattberg's expanded polystyrene mould

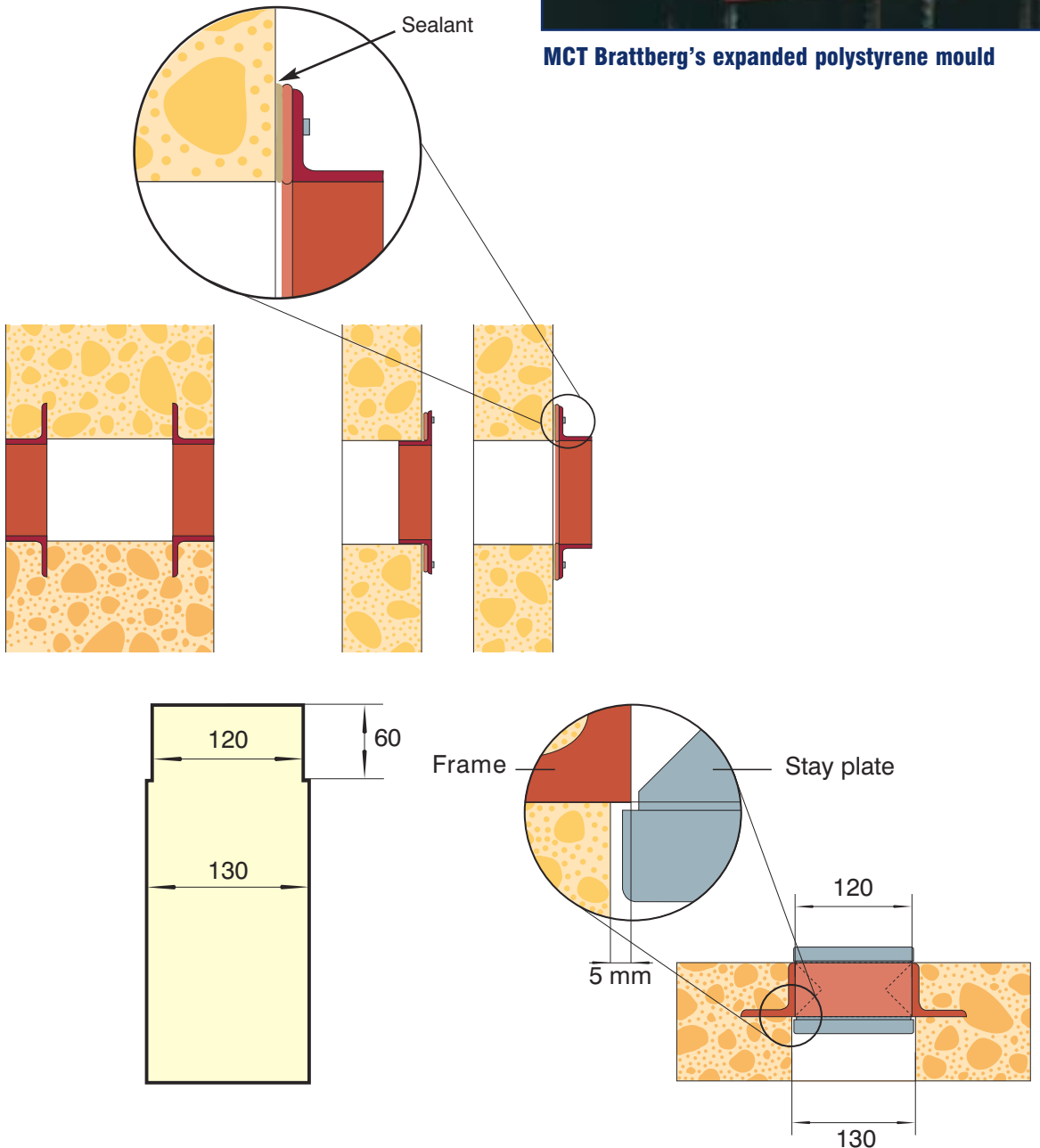

RGG

RGG frames and the counter frame are screwed into the wall. A Silicon Sealant should be used between the wall and the flange to provide a tight seal. The galvanised counter frame is available with three different depths to suite the wall thickness.

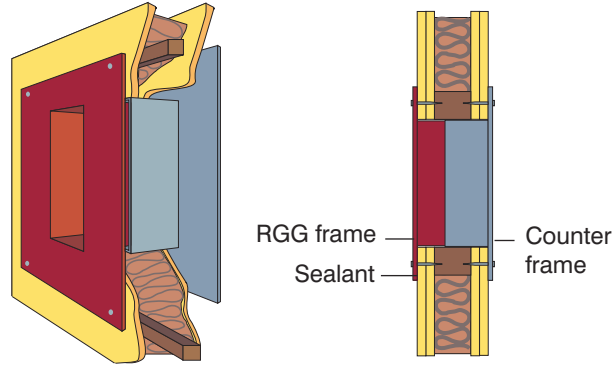

RGP

RGP can be installed in steel sleeves, cast or diamond drilled holes. RGP formers can be also supplied for walls/floor upto 2 metres thick. They are manufactured from plastic coated cardboard and come supplied with end caps.

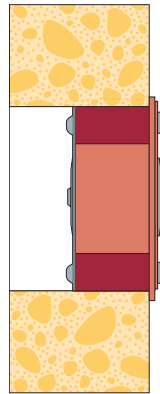

MCT Brattberg's casting form

- The Company
- Why MCT Brattberg
- The Products
- Multiple Frames
- Planning the Packing Space
- Frames for Marine/Offshore
- Frames for Civil/Industry
- RGP Frames & Seals
- Blocks & Components
- Frame Installation Methods**
- Packing Guides
- EMC Protection
- Deck & Bulkhead Glands
- SR Cable & Pipe Seals
- MSR Cable Glands
- X-Series Cable Transit
- Transit Planning Software

Packing Guide

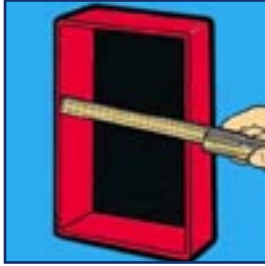

1 Measure the opening to ensure that its size conforms with tolerance standards (120.5 ± 0.5)

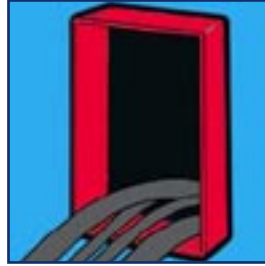

2 Ensure the internal surfaces of the frame are clean. Then pull cables through, placing the largest at the bottom.



3 Begin packing. A stayplate is inserted between each row of insert blocks.

STG Endpacking



4 Insert the compression plate in the frame before the last row of blocks.



5-6 Insert the last row of blocks. Tighten the compression plate bolt until the tongue of the STG slides into position around the bolt (32mm maximum from the inside of the frame to the top of the compression plate).



7 Fit tongue and insert STG around the compression bolt. Tighten the nuts on the endpacking to compress and complete the seal. Approximately 12-15mm of thread should protrude on each bolt.

PTG Presswedge



4 Insert two stayplates into the frame before the last row of blocks.



5 Install the PTG Presswedge at top of the frame. Then insert the last row of blocks.



6 Tighten the nuts until about 12-15mm of thread protrudes on each bolt.



7 The PTG Presswedge can be installed at any position within the frame.

RGSC STG End Packing

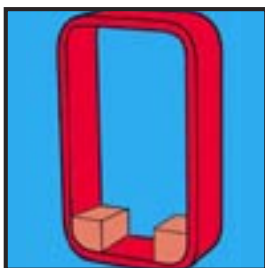

Begin packing with the corner blocks. Insert STG Endpacking with the tongue around the compression bolt. Tighten the nuts on the seal. Approximately 12-15mm of thread should protrude on each bolt.

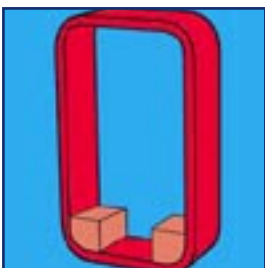

RGSC PTG Presswedge



Begin packing using the corner blocks. Place the PTG Presswedge anywhere, except at the top or bottom.

Horizontal Installation



1 Measure the opening to ensure that its size conforms with tolerance standards (120.5 ± 0.5).

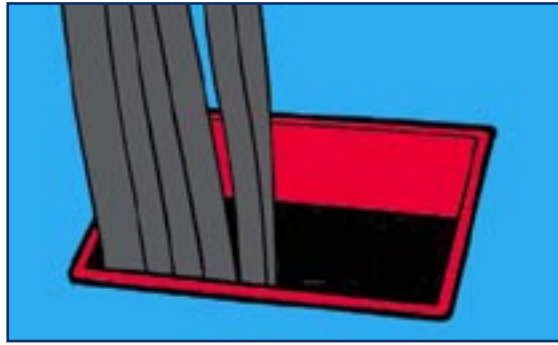

2 Ensure the internal surfaces of the frame are clean. Then pull cables through, placing the largest at the bottom.



3 In horizontal installations, gravity makes it necessary to use the stayplates to hold the insert blocks in place. Therefore, place the stayplates in the frame first, dividing up the rows of cables according to your RG-plan. Also insert the compression plate at this stage.

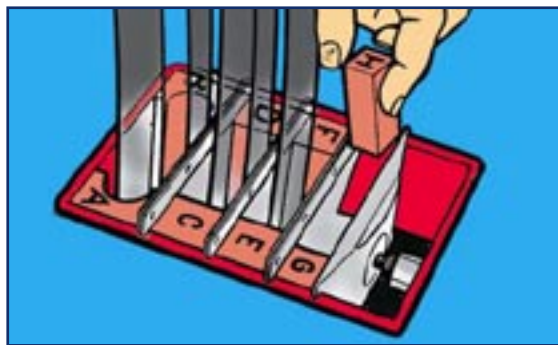

4 Insert the outer blocks first (A, B, C etc.). Then insert the remaining blocks. Note: The block A should be turned 90°, as shown in the picture.

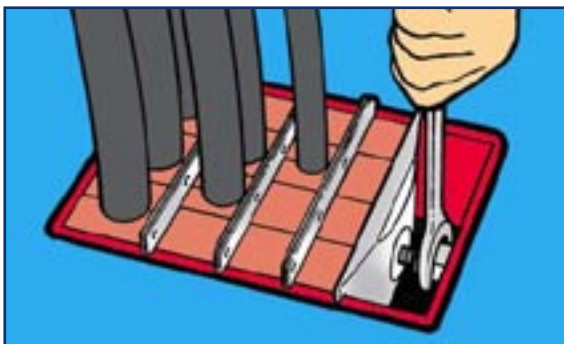

5 Insert the last row of blocks. Tighten the compression plate bolt until the tongue of the STG slides into position around the bolt (32mm maximum from the inside of the frame to the top of the compression plate).

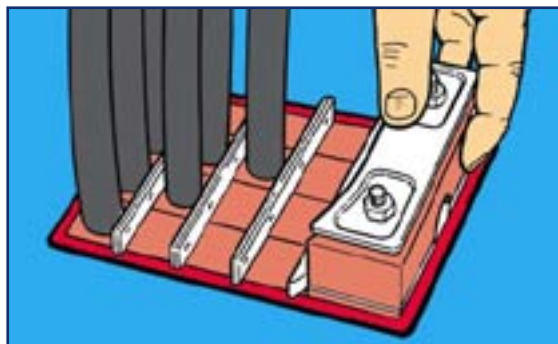

6 Fit tongue and insert STG around the compression bolt. Tighten the nuts on the endpacking to compress and complete the seal. Approximately 12-15mm of thread should protrude on each bolt.

The Company

Why MCT Brattberg

The Products

Multiple Frames

Planning the Packing Space

Frames for Marine/Offshore

Frames for Civil/Industry

RGP Frames & Seals

Blocks & Components

Frame Installation Methods

Packing Guides

EMC Protection

Deck & Bulkhead Glands

SR Cable & Pipe Seals

MSR Cable Glands

X-Series Cable Transit

Transit Planning Software

Add Block



Select insert to match cable diameter.



Place insert into AddBlock and press into position.



Remove all unused inserts.

Plug & Wraps



Plugs & wraps are available to convert AddBlocks to spare blocks.



Choose an AddBlock suitable for the plug & wraps.



Place the plug in the AddBlock, press into position.

U-Block



Use a U-Block to convert Insert, AddBlock or U-Block to the next module size.

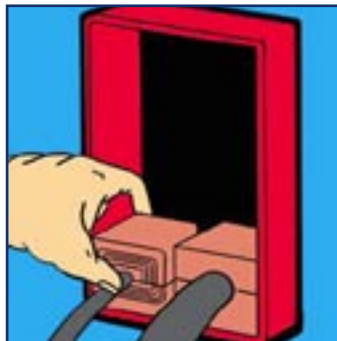

Start packing the frame as shown in the packing guide. (see page 42)

Disassembly



1 Remove the nuts and the hardware from the face of the endpacking.

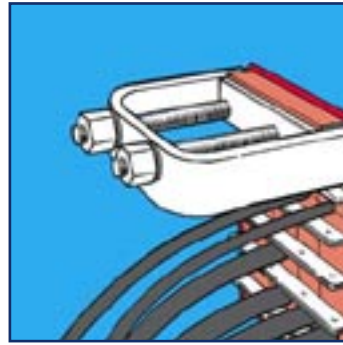

2 Attach the endpacking puller to the bolts.

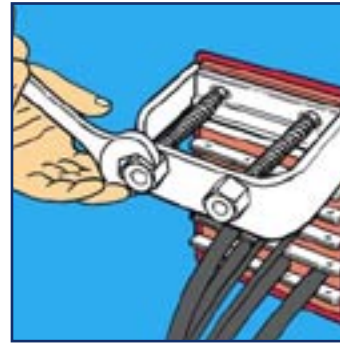

3 Tighten the nut on the puller to remove the STG endpacking.

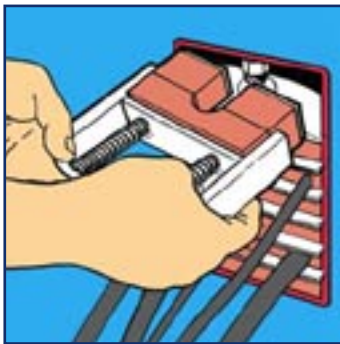

4 Remove the STG Endpacking.



RGP Packing Guide

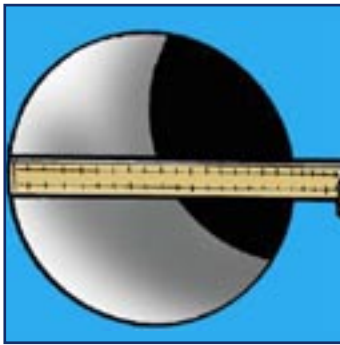

1 Measure the opening to ensure that its size conforms with tolerance standards. (see page 29)



2 Insert the RGP frame in the opening. No lubricant should be applied to the hole or to the outside of the frame.

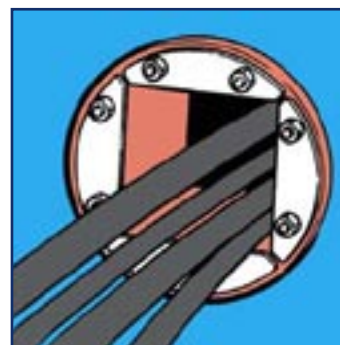

3 Pull the cables or pipes through, placing the largest at the bottom of the frame.

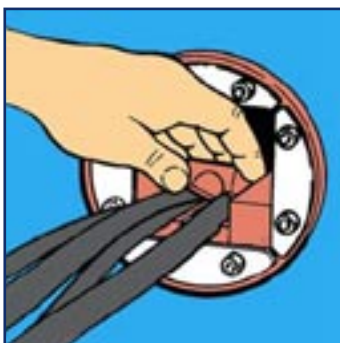

4 Begin packing.

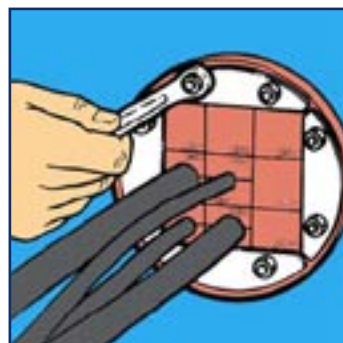

5 Tighten the bolts to compress and complete the seal. Approximately 10 to 12mm of thread should protrude on each bolt.

- The Company
- Why MCT Brattberg
- The Products
- Multiple Frames
- Planning the Packing Space
- Frames for Marine/Offshore
- Frames for Civil/Industry
- RGP Frames & Seals
- Blocks & Components
- Frame Installation Methods
- Packing Guides
- EMC Protection
- Deck & Bulkhead Glands
- SR Cable & Pipe Seals
- MSR Cable Glands
- X-Series Cable Transit
- Transit Planning Software

EMC Protection

The E series frames and components provide the same protection as the standard MCT Brattberg system but with added, built-in protection against electromagnetic pulse (due to lightning or nuclear blast) and interference, electronic sabotage (synthetic EMP) and static electricity. The secret is a tempered metal sheet which systematically stops electrical current from passing along the cable screening through the seal and successfully function as an extended wall screen. All dimensions are exactly the same for the standard MCT Brattberg components.

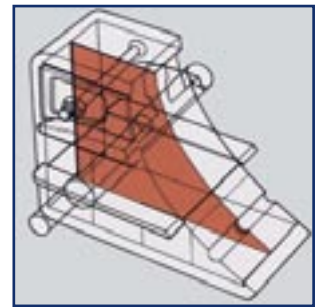

E-RGP

The E-RGP is a round Lycron frame for assembly in sleeves. A tempered metal sheet forms the contact between insert block and sleeve. The seal is available in 5 sizes with the designations E-RGP -50, -70, -100, -150 and -200 (for dimensions see page 29).

The E-RGP transit is manufactured from Lycron. The metal fittings are galvanised, mild steel or stainless steel finish.



Sleeves

Pipe sleeves are fabricated from 8mm thick seamless pipe and are used to house the E-RGP seal.



Frames

Frames are available in 4 sizes, designated -2, -4, -6, and -8 depending on height. The internal width is always 120mm and the depth is 60mm.

Material

The frames are manufactured in the following materials:

- Steel
- Stainless steel
- Aluminium

Steel, natural or with a hot dipped galvanised finish.

Components

E-Insert Blocks/AddBlocks

Seal each cable and pipe individually. The tempered metal sheet forms a contact between the cable braid or pipe and frame. Insert blocks with hole diameters from 4 up to 54mm.



E-Spare Blocks

Seal the unused space in the frame for future installation. The tempered metal sheet forms a contact between surrounding blocks and the frame.

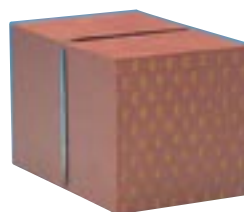

Marking

EMP Blocks are marked on one end to show correct installation.

Stayplates

Placed between each row of insert blocks to aid installation and to increase mechanical stability. Material: Brass.



Endpacking E-STG

The E-STG Endpacking is installed between the compression plate and the frame to make the seal complete and EMC-tight. The tempered metal sheet forms a contact between the frame and the compression plate.

Hardware is either galvanised mild steel or stainless steel.

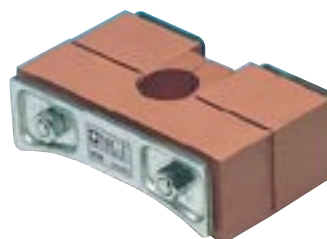

Compression Plate

Fitted before the last row of insert blocks. The bolt in the compression plate is tightened to compress the system. Material: Galvanised Cast iron.



Presswedge E-PTG-120

E-PTG Presswedge can be used alternative to STG Endpacking and the Compression Plate and can also be installed in any position in the frame. Hardware is either galvanised mild steel or stainless steel.



Tweezers

Grips the tempered metal sheet and assists insertion of the last row of blocks.



EMP Blocks & components are identified with a 'E' prefix e.g. E-30/12, ESTG etc

The Company

Why MCT Brattberg

The Products

Multiple Frames

Planning the Packing Space

Frames for Marine/Offshore

Frames for Civil/Industry

RGP Frames & Seals

Blocks & Components

Frame Installation Methods

Packing Guides

EMC Protection

Deck & Bulkhead Glands

SR Cable & Pipe Seals

MSR Cable Glands

X-Series Cable Transit

Transit Planning Software

Installation E-RGS, E-RGB

- 1** Clean the inside of the frame (bare steel) carefully to ensure good electrical contact between the tempered metal sheet and the frame.

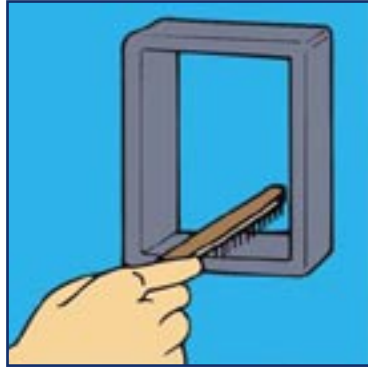

- 2** Pull cables to final position. Mark cable 30mm from front edge of frame. Remove cable sheath 5mm on either side of the line.

- 3** When packing the transit, ensure all the insert blocks have identification marks facing the installer.



- 4** Position the stayplates between each layer of insert blocks.

- 5** Before the final row of blocks, the compression plate is installed. Alternatively, the E-PTG Presswedge with an additional stayplate can be fitted.



- 6** Tweezers can be used, if required to aid installation of the last row of blocks.

- 7** Insert the last row of blocks. Tighten the compression plate bolt until the tongue of the STG slides into position around the bolt (32mm maximum from the inside of the frame to the top of the compression plate).



- 8** Fit tongue and insert STG around the compression bolt. Tighten the nuts on the endpacking to compress and complete the seal. Approximately 12-15mm of thread should protrude on each bolt.

Installation E-RGP



1 Clean the inside of the frame. (bare steel).

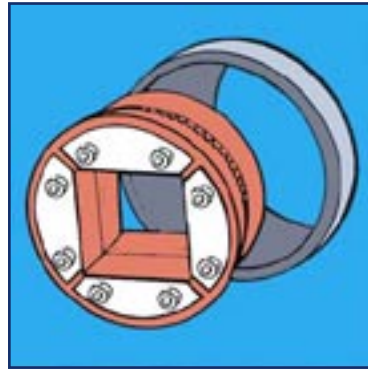

2 Insert the E-RGP into the opening.

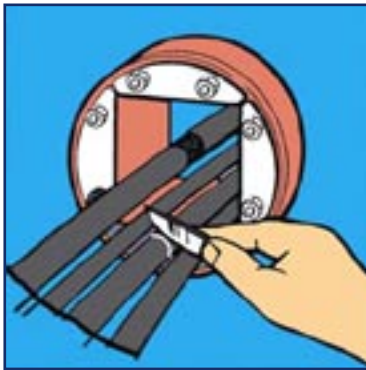

3 Pull cables to final position. Mark cable 30mm from front edge of frame. Remove cable sheath 5mm on either side of the line.

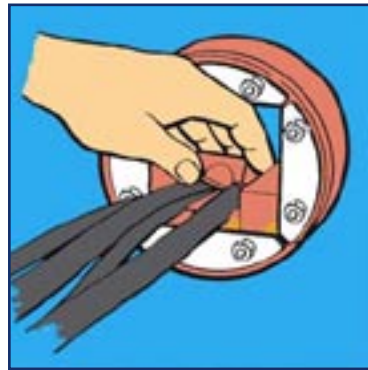

4 When packing the transit, ensure all the insert blocks have identification markings facing the installer.



5 Tweezers can be used, if required, to aid installation of last row of blocks.

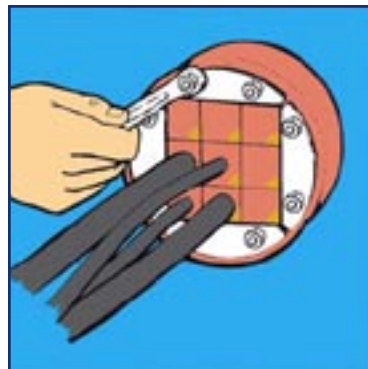

6 Tighten the nuts so that 10-12mm of thread is visible.

The Company

Why MCT Brattberg

The Products

Multiple Frames

Planning the Packing Space

Frames for Marine/Offshore

Frames for Civil/Industry

RGP Frames & Seals

Blocks & Components

Frame Installation Methods

Packing Guides

EMC Protection

Deck & Bulkhead Glands

SR Cable & Pipe Seals

MSR Cable Glands

X-Series Cable Transit

Transit Planning Software

Deck & Bulkhead Penetration Glands



- **Lloyds Certified to A60 Approval**
- **Pressure Tested to Bar 15**
- **Certified to DEF STAN 07-2251 (formerly NES 510)**
- **NATO stock coded**
- **Supplied Complete with Flexible Seal**
- **Available with EMC/EMI protection**
- **No additional parts or on site machining required**
- **Glands supplied in galvanized mild steel with brass nuts
other materials available upon request**

Deck & Bulkhead Penetration Glands

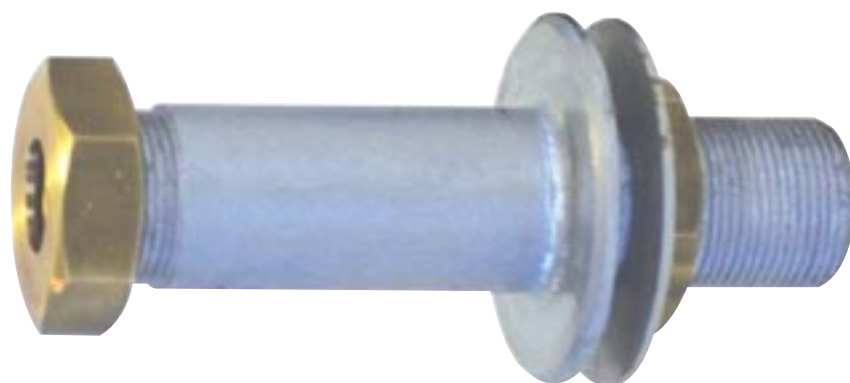

150mm Gland Assembly With 30mm Long Thread

Ref	Cable Range Min Max		Metric Thread	Flange Diameter	Nut A/F	Nato Stock Code
M10	3	10	M30 x 2	60	36	5975-99-687-5863
M16	4	16	M33 x 2	70	46	5975-99-983-1047
M25	13	25	M50 x 2	80	65	5975-99-219-6555
M35	23	35	M60 x 2	100	80	5975-99-724-3182
M50	32	50	M75 x 2	120	100	5975-99-786-1504
M60	48	60	M90 x 2	150	120	5975-99-915-4797

150mm Gland Assembly With 70mm Long Thread

Size	Cable Range Min Max		Metric Thread	Flange Diameter	Nut A/F	Nato Stock Code
M10	3	10	M30 x 2	60	36	5975-99-666-2732
M16	4	16	M33 x 2	70	46	5975-99-666-2735
M25	13	25	M50 x 2	80	65	5975-99-131-9897
M35	23	35	M60 x 2	100	80	5975-99-843-2222
M50	32	50	M75 x 2	120	100	5975-99-983-1048
M60	48	60	M90 x 2	150	120	5975-99-700-7973

75mm Gland Assembly With 30mm Long Thread

Size Ref	Cable Range Min Max		Metric Thread	Flange Diameter	Nut A/F	Nato Stock Code
M10	3	10	M30 x 2	60	36	5975-99-666-2721
M16	4	16	M33 x 2	70	46	5975-99-986-4129
M25	13	25	M50 x 2	80	65	5975-99-666-2722
M35	23	35	M60 x 2	100	80	5975-99-880-0222
M50	32	50	M75 x 2	120	100	5975-99-344-8410
M60	48	60	M90 x 2	150	120	5975-99-724-3178

75mm Gland Assembly With 70mm Long Thread

Size Ref	Cable Range Min Max		Metric Thread	Flange Diameter	Nut A/F	Nato Stock Code
M10	3	10	M30 x 2	60	36	5975-99-325-0493
M16	4	16	M33 x 2	70	46	5975-99-670-5091
M25	13	25	M50 x 2	80	65	5975-99-887-0270
M35	23	35	M60 x 2	100	80	5975-99-500-9692
M50	32	50	M75 x 2	120	100	5975-99-405-5217
M60	48	60	M90 x 2	150	120	5975-99-739-8420

The Company

Why MCT Brattberg

The Products

Multiple Frames

Planning the Packing Space

Frames for Marine/Offshore

Frames for Civil/Industry

RGP Frames & Seals

Blocks & Components

Frame Installation Methods

Packing Guides

EMC Protection

Deck & Bulkhead Glands

SR Cable & Pipe Seals

MSR Cable Glands

X-Series Cable Transit

Transit Planning Software

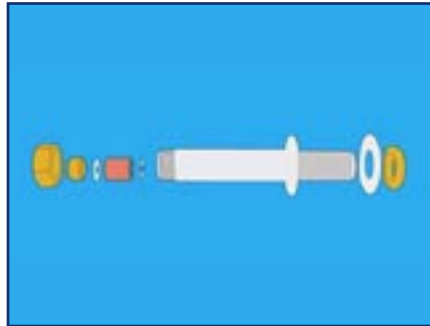

Component parts.



Clearance hole = Thread diameter + 2mm max.



1 Apply sealant to underside of flange (6mm bead).



2 Insert gland through hole.

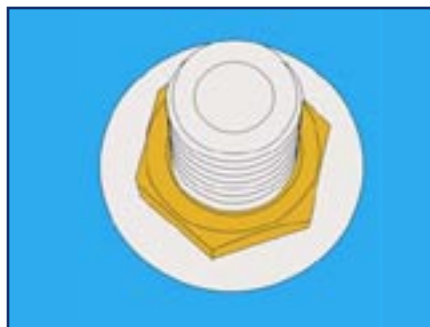

3 Fit washer and tighten lock nut.

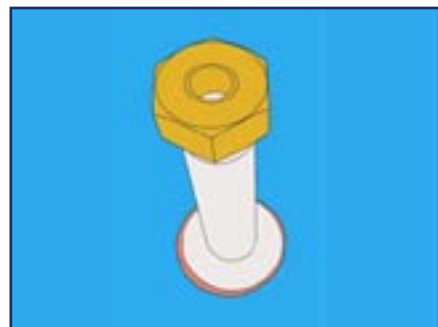

4 Wipe excess sealant from around flange.



5 Remove top nut & internal parts.

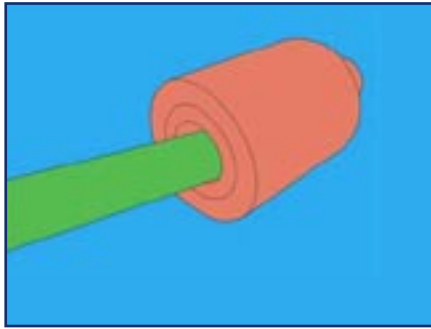

6 Remove the minimum number of rings to allow cable to pass through the seal.



7 Size washers to cable & insert if required.



8 Push seal into place.



9 Fit top washer if required.



10 Fit compression spigot.

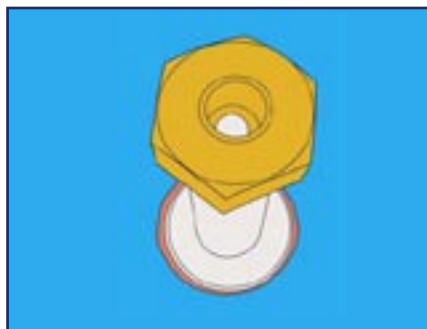

11 Locate nut on compression spigot.



12 Push cable through assembled gland & tighten nut.

The Company

Why MCT Brattberg

The Products

Multiple Frames

Planning the Packing Space

Frames for Marine/Offshore

Frames for Civil/Industry

RGP Frames & Seals

Blocks & Components

Frame Installation Methods

Packing Guides

EMC Protection

Deck & Bulkhead Glands

SR Cable & Pipe Seals

MSR Cable Glands

X-Series Cable Transit

Transit Planning Software

SR Cable & Pipe Seals



- **Lloyds Certified to A 60 approval**
- **Pressure Tested to 5 Bar**
- **Gland Manufactured from Stainless Steel**
- **Sleeves supplied in mild steel (primed)**
- **No additional parts or on site machining required**
- **Other solutions to meet customer specification available on request**



The SR Gland is designed to seal cables between 4 & 100mm diameter.

The seal can be supplied cut to allow pre terminated cable to be installed.

It is supplied with a centre core providing a seal prior to cable installation.



When the cable is inserted into the gland simply tighten the compression bolts equally until cable is secure.



Once complete the seal will provide an effective barrier against fire, water, dust, vermin etc.

Ref	Cable Diameter		Pipe \varnothing
	Min	Max	
SR 25	4	12	33.4
SR 38	11	24	48.3
SR 49	20	32	60.3
SR 62	30	42	73.0
SR 77	40	52	88.9
SR 102	50	70	114.3
SR 125	65	85	140.0
SR 150	80	100	168.3

The Company

Why MCT Brattberg

The Products

Multiple Frames

Planning the Packing Space

Frames for Marine/Offshore

Frames for Civil/Industry

RGP Frames & Seals

Blocks & Components

Frame Installation Methods

Packing Guides

EMC Protection

Deck & Bulkhead Glands

SR Cable & Pipe Seals

MSR Cable Glands

X-Series Cable Transit

Transit Planning Software

MSR Cable Gland



- **Lloyds Certified to A 60 Approval (metal housing)**
- **Pressure tested to 15 bar**
- **Each Gland accommodates a range of cable Diameters**
- **No additional parts or on site machining required**
- **Gland Manufactured from Stainless Steel, Housing available in Polyamide 6 or Nickel Plated Brass**

MSR Cable Gland



The MSR Gland is designed to seal upto 8 cables between 4 & 16mm diameter.

You simply remove the centre core and minimize the number of rings to enable cables to pass through.

When all cables are inserted into the gland simply tighten the four Hex Screws equally using the key provided.

Once complete the seal will provide an effective barrier against fire, water, dust, vermin etc.

Gland Ref	Cable Diameter Max	No Cables
MSR 25	4	4
MSR 32 Type-1	7	4
MSR 32 Type-2	10	2
MSR 40 Type-1	10	3
MSR 40 Type-2	7	4
MSR 50 Type-1	8	5
MSR 50 Type-2	14	3
MSR 63 Type-1	16	4
MSR 63 Type-2	10	8

- The Company
- Why MCT Brattberg
- The Products
- Multiple Frames
- Planning the Packing Space
- Frames for Marine/Offshore
- Frames for Civil/Industry
- RGP Frames & Seals
- Blocks & Components
- Frame Installation Methods
- Packing Guides
- EMC Protection
- Deck & Bulkhead Glands
- SR Cable & Pipe Seals
- MSR Cable Glands**
- X-Series Cable Transit
- Transit Planning Software

X-Series

Frames

Specification

- Polyester glass filled compression moulding
- UV stabilised material with low smoke index
- Ultra-low weight
- High strength

Frames Supplied With:-

- Fixing screws (M6 button head socket screw complete with nuts and washers)
- Compression screws (M6 countersunk head)
- Compression system
- Gasket
- 4mm Allen Key
- Optional extras include Adaptor Flange and Blanking Plate. Details on request.

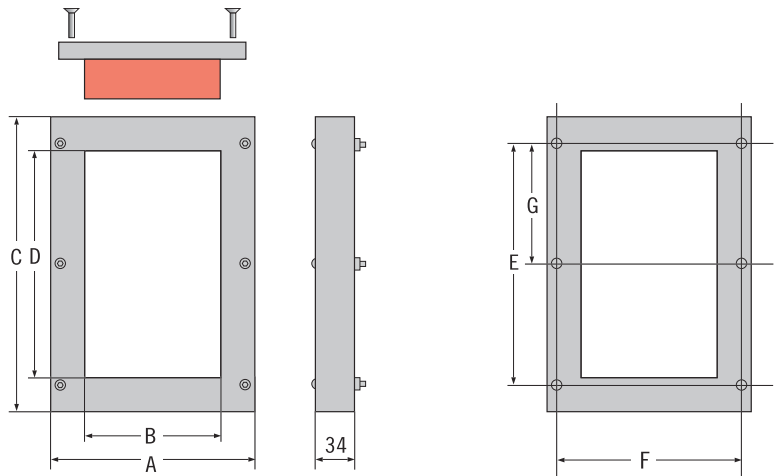

Sizes

Type	A	B	C	D
X1	178	120	260	200
X2	118	60	210	150

Fixing Hole Dimensions

Type	E	F	G
X1 (6 holes M6 clearance)	215	160	107.5
X2 (4 holes M6 clearance)	130	88	-

N.B. Multiple frames are available. Details on request.

Testing

Fire BS 476 Pt 20 1 hr integrity

Pressure IP 67

Vibration Available on request

UV Available on request

Temperature Range Available on request

Chemical Resistance Available on request

Sizing Cables

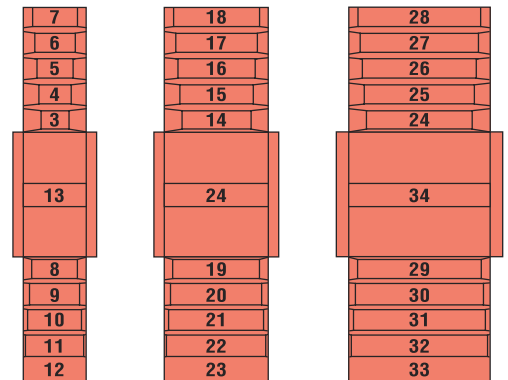

Blocks

Block Size	Width	Height	Cable/Pipe Size
	A	B	C
X20/3-13	20	10	2.5 - 13.5
X30/14-24	30	15	13.5 - 24.5
X40/24-34	40	20	23.5 - 34.5

N.B. Sold as complete block sealed (2 half blocks & plug).

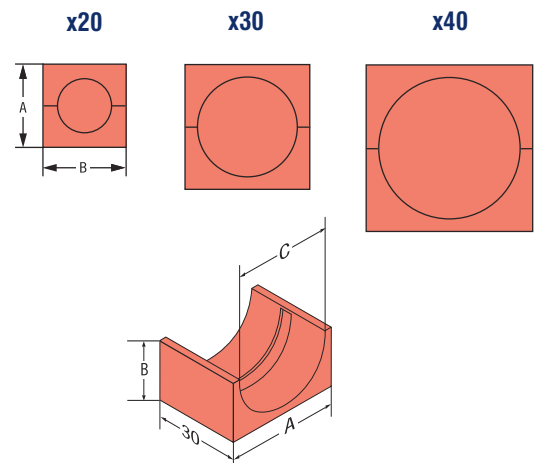

Staybars

Stainless steel 3mm diameter supplied in 2 sizes:

Type 1 120mm long ref SB 120

Type 2 60mm long ref SB 60

N.B. For pressure installation lubricate all components liberally.

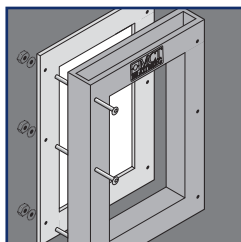

1 Fix frame to opening using gasket and M6 screws supplied.

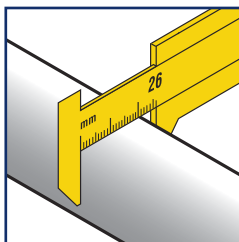

2 Measure cable. In this example cable has a diameter of 26mm.

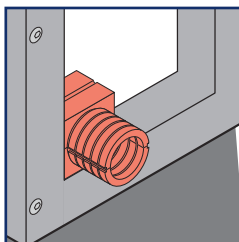

3 Once cable is sized select appropriate block.

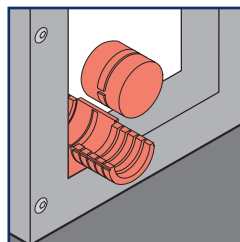

4 Remove top half of block and plug.

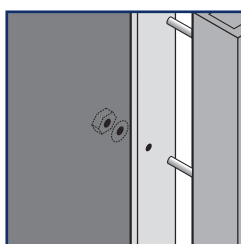

5 Detach sealing rings from main block and retain ring corresponding to measured cable size. In this example 26mm.

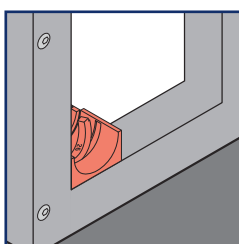

6 Place the 26mm sealing ring in centre groove of block.

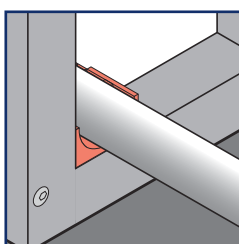

7 Place cable on block.

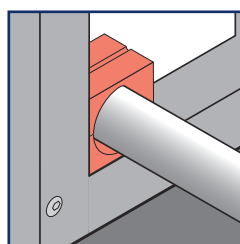

8 Replace top of block to encase cable.

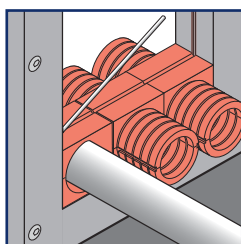

9 If more cables are required repeat the sequence. If not insert blanks to complete row and insert staybar to secure.

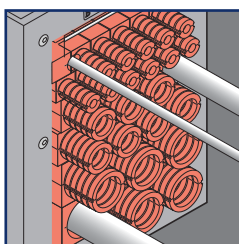

10 Build up frame repeating the process described in steps 2-9. In this example 2 more cables have been added using other block sizes.

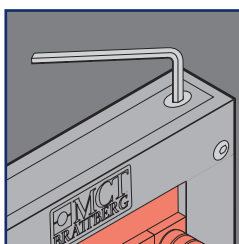

11 Insert compression system and tighten using allen key.

The Company

Why MCT Brattberg

The Products

Multiple Frames

Planning the Packing Space

Frames for Marine/Offshore

Frames for Civil/Industry

RGP Frames & Seals

Blocks & Components

Frame Installation Methods

Packing Guides

EMC Protection

Deck & Bulkhead Glands

SR Cable & Pipe Seals

MSR Cable Glands

X-Series Cable Transit

Transit Planning Software

MCT Brattberg - WinRG Plan Transit Design Manager Software

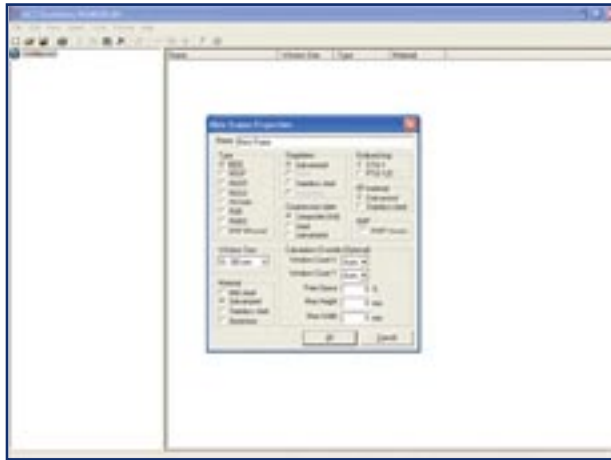

1 Configure cable/pipe penetrations quickly and easily with MCT Brattberg Cable Transit Planning Software. Simply input the transit requirements and software automatically configures the seal, along with all necessary components, blank blocks, stayplates and compression systems - at the touch of a button. Faster and simpler than time-consuming manual methods, it's the perfect solution for busy engineers/designers.

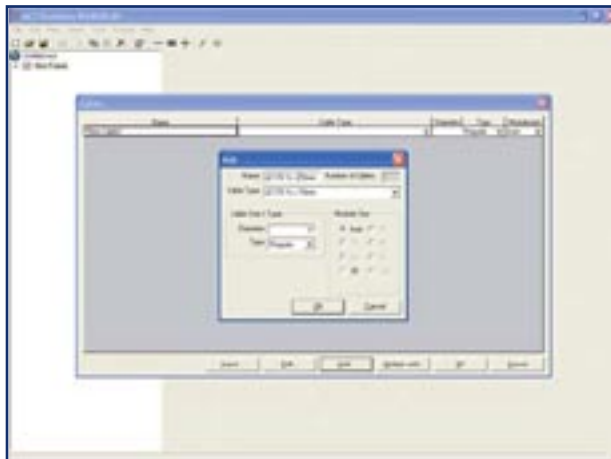

2 This software is designed to be user friendly.

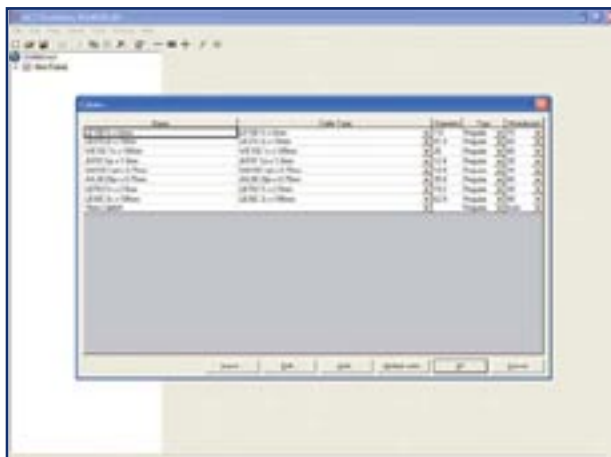

3 The software includes a wealth of project-specific information ready to use in your designs:

- frame/node name/location
- cable name(s) with type and diameter
- block type
- compression type
- expansion capacity

Select from the available options to adapt an existing project, or to create an entirely new design.

4 See your designs in overview, as packing plans, or as full/partial material take-offs.

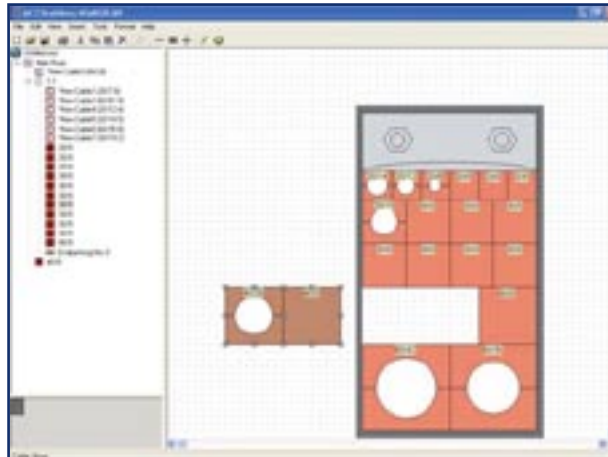

5 The software also offers easy interaction with client documentation and CAD systems via its import/export facilities.

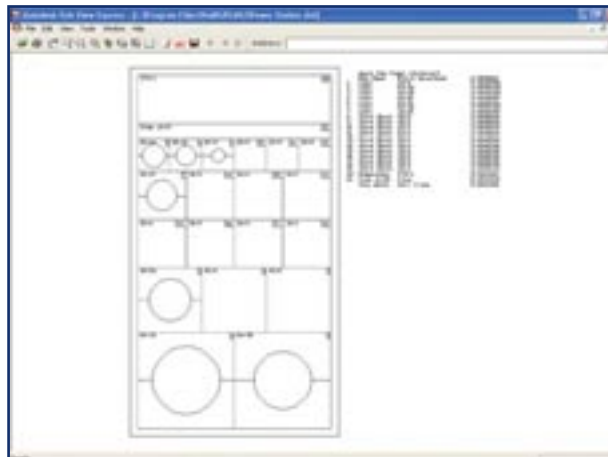

6 This indispensable software is available from MCT Brattberg free of charge: (software installation takes approx. 2 mins). Registered users can also receive regular product upgrades to ensure that your designs are always up to date.

Flexible, accessible and powerful, the Cable Transit Planning Software is an invaluable solution for busy engineers that could drastically reduce your transit planning time. For those who already benefit from MCT Brattberg's services, it's yet another step forward in quality of service.

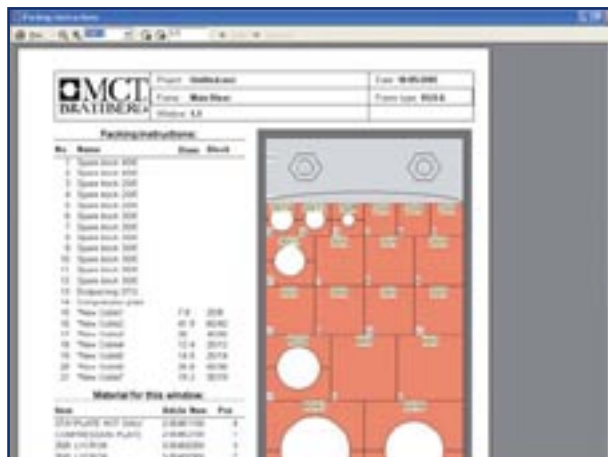

- The Company
- Why MCT Brattberg
- The Products
- Multiple Frames
- Planning the Packing Space
- Frames for Marine/Offshore
- Frames for Civil/Industry
- RGP Frames & Seals
- Blocks & Components
- Frame Installation Methods
- Packing Guides
- EMC Protection
- Deck & Bulkhead Glands
- SR Cable & Pipe Seals
- MSR Cable Glands
- X-Series Cable Transit
- Transit Planning Software

Testing

MCT Brattberg Cable Transits are tested against fire resistance to both A and H Classification.

Test Procedure

The temperature regime in the furnace during an A-Class fire is similar to that of a cellulose fire and during an H-Class fire similar to that of an oil fire. In a H-Class fire the increase in temperature is much faster than that of an

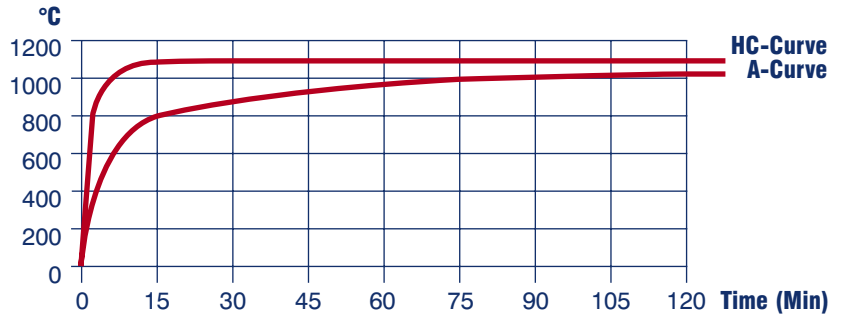

A-Class fire. The cable penetration must be tested both Vertically and Horizontally in order to be approved for general usage by the leading certifying authorities.

Location Of Thermocouples

The temperature is constantly measured at different points on the cables and on the face of the penetration during the fire test. How many thermocouples, what kind and their position on the test specimen is regulated by ISO & IMO.

Integrity

The integrity of the cable penetration must be maintained throughout the test period (A-Class 60 Minutes, H-Class 120 Minutes). The occurrence of flaming on the unexposed face or ignition of a cotton wool pad applied to any gap or fissure that appears in the test specimen constitutes a loss of integrity.

Insulation

The limit of temperature increase on the non fire side of the penetration is stipulated in ISO 834.

The maximum acceptable temperature increase at any point on the penetration during the test is 180°C.

An approved fire test gives the penetration a classification where the fire is specified (A- or H- Class Fire) and the time for which the penetration was able to resist the fire in respect of the maximum allowed temperature increase on the non fire side of the penetration (180°C).

For example, a penetration that withstands an H-Class fire for 120 minutes is classed as H120 and a penetration that withstands an A-Class fire for 60 minutes is classed A60.

Fire Classes

If the 180°C temperature increase is not exceeded during the stipulated time the penetration is approved and can be classified.

Example Of Fire Classes

*A0 and H0 relates to no temperature restriction on the non fire side of an un-insulated construction.
 H0-400°C relates to a restriction of 400°C maximum on the non fire side of an un-insulated construction.
 A0-H0 and H0-400°C must also meet the integrity requirements, not allowing cracks or openings to develop through which flames or hot gases can pass.

A and H Class cable penetrations are also required to consist of materials that are non-combustible.

Class	Test Requirements Attained	
	Integrity (Min)	Insulation (Min)
A0	60	0*
A15	60	15
A30	60	30
A60	60	60
H0	120	0*
H0-400	120	0*
H60	120	60
H120	120	60



CABLE JOINTS, CABLE TERMINATIONS, CABLE GLANDS, CABLE CLEATS
FEEDER PILLARS, FUSE LINKS, ARC FLASH, CABLE ROLLERS, CUT-OUTS

11KV 33KV CABLE JOINTS & CABLE TERMINATIONS
FURSE EARTHING

www.cablejoints.co.uk

Thorne and Derrick UK

Tel 0044 191 490 1547 Fax 0044 191 477 5371
Tel 0044 117 977 4647 Fax 0044 117 9775582